











Pulleys

	Wedge belt pulleys	242
	Classical V-belt pulleys	256
	QD Classical V-belt pulleys	264
	Narrow wedge belt pulleys	273
	QD Narrow wedge belt pulleys	280
	HiTD pulleys	289
	Classical timing pulleys	301
	Metric timing pulleys	313

SKF Pulleys

W nazewnictwie kół pasowych oferowanych przez SKF został przyjęty przyrostek PHP.

Wszystkie koła pasowe mają wymiary umożliwiające współpracę ze standardowymi pasami.

Produkowane przez SKF koła pasowe są oznaczane zgodnie z tradycyjnym formatem podstawowego oznaczenia części - według ISO, BS lub DIN.

Koła pasowe - pasy klinowe

Struktura oznaczenia kół pasowych SKF jest wyjaśniona na poniższym przykładzie.

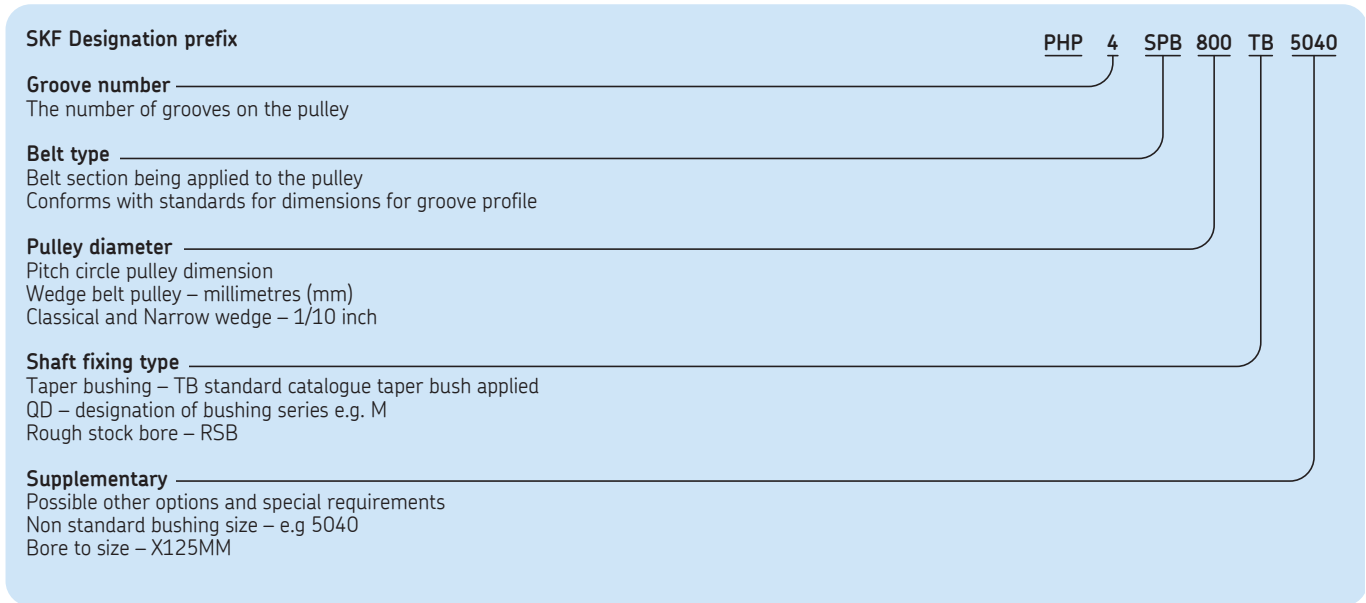

Pulleys (PHP Product Group)

Classical and trapezoidal inch pitch timing pulleys (MXL, XL, L, H, XH, XXH) are manufactured according to ISO 5294.

Metric pitch series timing pulleys (T/AT) are manufactured according to DIN 7721.

All SKF V-belt pulleys are manufactured to the standards ISO 4183, DIN 2211, ANSI Narrow V-belt pulley IP-22 and the ANSI Classical V-belt pulley IP-20. They are interchangeable with type SPA, SPB, SPC and SPZ. The pulleys are made from cast iron G3000 (GG) to American standard "SAEJ431AVG96".

Following are the requirements of G3000:

- Tensile strength = 207Mpa
- Hardness = HB 187-241
- Chemical composition C 3,1-3,4 %, Si 1,9-2,3 %, Mn 0,6-0,9 %, S = 0,15 %, P = 0,15%

After being machined, pulleys are phosphated and treated with a rustproof oil.

All pulleys are statically balanced to G6.3 according to ISO 1940. After balanced the pulleys are suitable for the linear speed of not more than 35m/s. Two Plane (Dynamic) balancing can be provided on request. SKF can issue a certificate stating that all pulleys are dynamically balanced in case of any special customer request.

Standard pulley groove dimensions DIN2211/1 & BS3970

Classical V-belt pulleys | Narrow Wedge V-belt pulleys (DIN / BS / ISO) | Narrow wedge belt pulleys (RMA)

Nomenclature:

- α Pulley groove included angle (°)
- OD Outside diameter
- PD Effective (pitch) diameter
- b_d Effective width at pitch line
- b_1 Groove top width
- c Distance from pitch to outside diameter (= OD - PD/2)
- e Transverse pitch of grooves (to centers)
- f Minimum recommended distance from edge of pulley to centre of first groove
- t Total groove depth

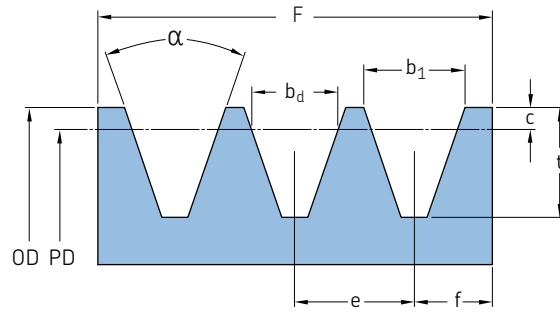

Classical V-belt pulleys

Classical belt series	Pitch diameter range	Groove angle	Dimensions				
			α	b_1	b_d	t	c
–	mm	°	mm				
13/A-17/B	85 - 170	34	15,55	15,88	19,05	4,45	12,70
	Over 170	38	15,55	15,88	19,05	4,45	12,70
22/C	178 - 203	34	22,33	19,81	25,40	5,08	17,48
	203 - 305	36	22,53	19,81	25,40	5,08	17,48
	Over 305	38	22,73	19,81	25,40	5,08	17,48
32/D	305 - 330	34	31,98	26,67	36,53	7,62	22,23
	330 - 432	36	32,28	26,67	36,53	7,62	22,23
	Over 432	38	32,59	26,67	36,53	7,62	22,23
	Over 432	38	32,59	26,67	36,53	7,62	22,23
40/E	457 - 610	36	38,79	33,02	44,45	10,16	31,24
	Over 610	38	39,17	33,02	44,45	10,16	31,24

Narrow Wedge V-belt pulleys (DIN / BS / ISO)

Classical belt series	Pitch diameter range	Groove angle	Dimensions					
			α	b_1	b_d	$t(+0.6/-0.0)$	c	e
–	mm	°	mm					
SPZ	Up to & incl. 80	34	9,7	8,5	11,00	2,00	12,0 ± 0,3	8,0
	Over 80	38	9,7	8,5	11,00	2,00	12,0 ± 0,3	8,0
SPA	Up to & incl. 118	34	12,7	11,0	14,00	2,80	15,0 ± 0,3	10,0
	Over 118	38	12,7	11,0	14,00	2,80	15,0 ± 0,3	10,0
SPB	Up to & incl. 190	34	16,2	14,4	18,00	3,50	19,0 ± 0,4	12,5
	Over 190	38	16,2	14,4	18,00	3,50	19,0 ± 0,4	12,5
SPC	Up to & incl. 315	34	22,0	19,0	24,00	4,80	25,5 ± 0,5	17,0
	Over 315	38	22,0	19,0	24,00	4,80	25,5 ± 0,5	17,0

Narrow wedge belt pulleys (RMA)

RMA Belt series	Pitch diameter range	Groove angle	Dimensions					
			α	b_1	b_d	t	c	e
–	mm	°	mm					
3V, 3VX	Up to & incl. 90	36	8,89	8,89	8,64	0,64	10,3 ± 0,4	8,74
	Over 90 - 150	38	8,89	8,89	8,64	0,64	10,3 ± 0,4	8,74
	Over 150 - 305	40	8,89	8,89	8,64	0,64	10,3 ± 0,4	8,74
5V, 5VX	Over 305	42	8,89	8,89	8,64	0,64	10,3 ± 0,4	8,74
	Over 140 - 255	38	15,24	12,70	14,98	1,27	17,5 ± 0,4	3,20
	Over 255 - 405	40	15,24	12,70	14,98	1,27	17,5 ± 0,4	3,20
	Over 405	42	15,24	12,70	14,98	1,27	17,5 ± 0,4	3,20
8V, 8VX	Over 315 - 405	38	25,40	25,40	25,15	2,54	28,6 ± 0,4	6,40
	Over 405 - 570	40	25,40	25,40	25,15	2,54	28,6 ± 0,4	6,40
	Over 570	42	25,40	25,40	25,15	2,54	28,6 ± 0,4	6,40

Wedge belt pulleys
SPZ taper bushed

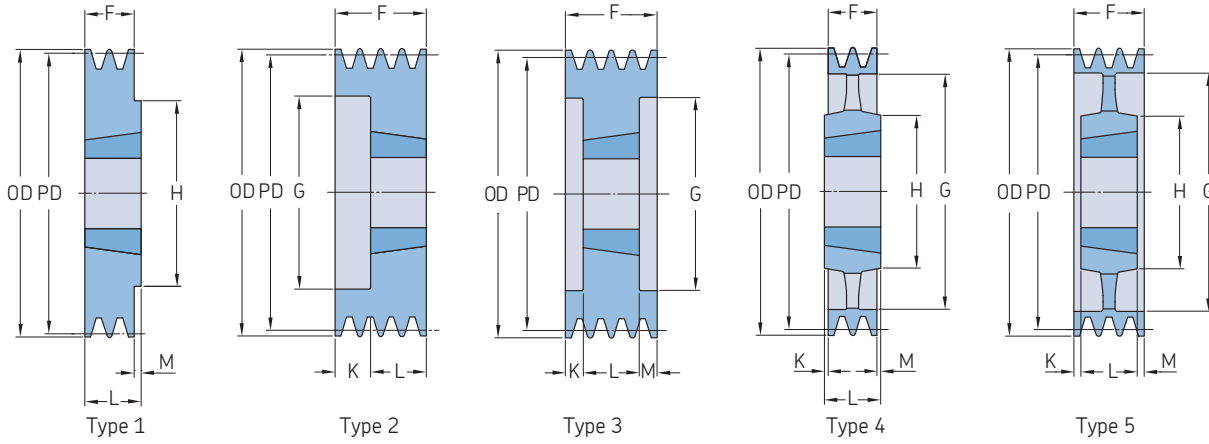

Section	Number of grooves	Pitch diameter PD	Pulley type	Bushing number	Dimensions									Mass*	Designation
					Outer diameter OD	B Min.	Max.	F	G	K	L	M	H		
		mm			mm									kg	
SPZ	1	50	9	1008	54,0	9	25	37	28	12,0	22	-	-	0,3	PHP 1SPZ50TB
		56	9	1008	60,0	9	25	37	23	12,0	22	-	-	0,5	PHP 1SPZ56TB
		60	1	1008	64,0	9	25	22	-	-	22	-	-	0,3	PHP 1SPZ60TB
		63	1	1108	67,0	9	28	16	-	-	22	6,0	62	0,3	PHP 1SPZ63TB
		67	1	1108	71,0	9	28	16	-	-	22	6,0	62	0,3	PHP 1SPZ67TB
		71	1	1108	75,0	9	28	16	-	-	22	6,0	62	0,4	PHP 1SPZ71TB
		75	1	1108	79,0	9	28	16	-	-	22	6,0	62	0,4	PHP 1SPZ75TB
		80	1	1210	84,0	11	32	16	-	-	25	9,0	75	0,5	PHP 1SPZ80TB
		85	1	1210	89,0	11	32	16	-	-	25	9,0	75	0,7	PHP 1SPZ85TB
		90	1	1210	94,0	11	32	16	-	-	25	9,0	75	0,7	PHP 1SPZ90TB
		95	1	1210	99,0	11	32	16	-	-	25	9,0	75	0,8	PHP 1SPZ95TB
		100	1	1210	104,0	11	32	16	-	-	25	9,0	75	0,9	PHP 1SPZ100TB
		106	1	1610	110,0	14	42	16	-	-	25	9,0	80	1,0	PHP 1SPZ106TB
		112	1	1610	116,0	14	42	16	-	-	25	9,0	80	1,1	PHP 1SPZ112TB
		118	1	1610	122,0	14	42	16	-	-	25	9,0	80	1,2	PHP 1SPZ118TB
		125	1	1610	129,0	14	42	16	-	-	25	9,0	80	1,3	PHP 1SPZ125TB
		132	1	1610	136,0	14	42	16	-	-	25	9,0	80	1,5	PHP 1SPZ132TB
		140	1	1610	144,0	14	42	16	-	-	25	9,0	80	1,7	PHP 1SPZ140TB
		150	1	1610	154,0	14	42	16	-	-	25	9,0	80	2,0	PHP 1SPZ150TB
		160	1	1610	164,0	14	42	16	-	-	25	9,0	80	2,2	PHP 1SPZ160TB
		170	1	1610	174,0	14	42	16	-	-	25	9,0	80	2,2	PHP 1SPZ170TB
		180	4	1610	184,0	14	42	16	152	-	25	9,0	92	2,1	PHP 1SPZ180TB
		190	4	1610	194,0	14	42	16	161	-	25	9,0	92	2,7	PHP 1SPZ190TB
		200	4	2012	204,0	14	50	16	172	-	32	16,0	100	3,4	PHP 1SPZ200TB
		224	4	2012	228,0	14	50	16	196	-	32	16,0	100	3,6	PHP 1SPZ224TB
		250	4	2012	254,0	14	50	16	222	8,0	32	8,0	100	4,6	PHP 1SPZ250TB
		280	4	2012	284,0	14	50	16	252	8,0	32	8,0	100	5,5	PHP 1SPZ280TB
		315	4	2012	319,0	14	50	16	287	8,0	32	8,0	100	6,7	PHP 1SPZ315TB
		355	4	2012	359,0	14	50	16	326	8,0	32	8,0	112	6,8	PHP 1SPZ355TB
		400	4	2012	404,0	14	50	16	371	8,0	32	8,0	112	6,9	PHP 1SPZ400TB
450	4	2517	454,0	16	60	16	421	14,5	45	14,5	120	7,2	PHP 1SPZ450TB		
SPZ	2	50	9	1008	54,0	9	25	49	28	25,0	22	-	-	0,4	PHP 2SPZ50TB
		56	9	1008	60,0	9	25	49	35	27,0	22	-	-	0,5	PHP 2SPZ56TB
		60	9	1108	64,0	9	25	49	36	27,0	22	-	-	0,7	PHP 2SPZ60TB
		63	6	1108	67,0	9	28	28	40	6,0	22	-	-	0,3	PHP 2SPZ63TB
		67	6	1108	71,0	9	28	28	42	6,0	22	-	-	0,4	PHP 2SPZ67TB
		71	6	1108	75,0	9	28	28	42	6,0	22	-	-	0,5	PHP 2SPZ71TB
		75	6	1210	79,0	11	32	28	51	3,0	25	-	-	0,5	PHP 2SPZ75TB
		80	6	1210	84,0	11	32	28	51	3,0	25	-	-	0,6	PHP 2SPZ80TB
		85	6	1610	89,0	14	42	28	60	3,0	25	-	-	0,6	PHP 2SPZ85TB
		90	6	1610	94,0	14	42	28	61	3,0	25	-	-	0,7	PHP 2SPZ90TB
		95	6	1610	99,0	14	42	28	66	3,0	25	-	-	0,8	PHP 2SPZ95TB
		100	6	1610	104,0	14	42	28	71	3,0	25	-	-	0,9	PHP 2SPZ100TB
		106	6	1610	110,0	14	42	28	76	3,0	25	-	-	1,1	PHP 2SPZ106TB
		112	6	1610	116,0	14	42	28	84	3,0	25	-	-	1,3	PHP 2SPZ112TB
		118	6	1610	122,0	14	42	28	90	3,0	25	-	-	1,5	PHP 2SPZ118TB
		125	6	1610	129,0	14	42	28	97	3,0	25	-	-	1,7	PHP 2SPZ125TB
		132	6	1610	136,0	14	42	28	104	3,0	25	-	-	2,0	PHP 2SPZ132TB
		140	6	1610	144,0	14	42	28	112	3,0	25	-	-	2,4	PHP 2SPZ140TB
		150	1	2012	154,0	14	50	28	-	-	32	4,0	100	2,6	PHP 2SPZ150TB
		160	1	2012	164,0	14	50	28	-	-	32	4,0	100	3,1	PHP 2SPZ160TB
		170	1	2012	174,0	14	50	28	-	-	32	4,0	100	2,8	PHP 2SPZ170TB
		180	8	2012	184,0	14	50	28	152	-	32	4,0	100	2,9	PHP 2SPZ180TB

* Mass does not include bushings.
Non-functional dimensions may vary slightly.

Wedge belt pulleys

SPZ taper bushed

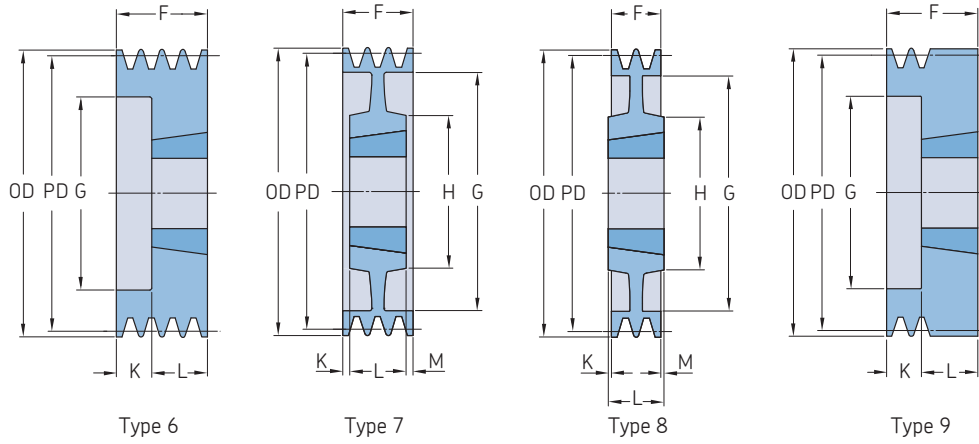

Section	Number of grooves	Pitch diameter PD	Pulley type	Bushing number	Dimensions			F	G	K	L	M	H	Mass*	Designation		
					Outer diameter OD	B Min.	Max.										
		mm	-	-	mm										kg	-	
SPZ	2	190	8	2012	194,0	14	50	28	161	-	32	4,0	100	3,1	PHP 2SPZ190TB		
		200	4	2012	204,0	14	50	28	171	-	32	4,0	100	3,4	PHP 2SPZ200TB		
		224	4	2012	228,0	14	50	28	196	-	32	4,0	100	4,5	PHP 2SPZ224TB		
		250	4	2012	254,0	14	50	28	222	2,0	32	2,0	100	5,4	PHP 2SPZ250TB		
		280	4	2012	284,0	14	50	28	252	2,0	32	2,0	100	6,2	PHP 2SPZ280TB		
			315	4	2012	319,0	14	50	28	286	2,0	32	2,0	100	7,2	PHP 2SPZ315TB	
			355	4	2012	359,0	14	50	28	326	2,0	32	2,0	112	8,6	PHP 2SPZ355TB	
			400	4	2517	404,0	16	60	28	371	8,5	45	8,5	120	9,9	PHP 2SPZ400TB	
			450	4	2517	454,0	16	60	28	421	8,5	45	8,5	120	11,2	PHP 2SPZ450TB	
	SPZ	3	63	6	1108	67,0	9	28	40	40	18,0	22	-	-	0,4	PHP 3SPZ63TB	
			67	6	1108	71,0	9	28	40	42	18,0	22	-	-	0,5	PHP 3SPZ67TB	
			71	6	1108	75,0	9	28	40	42	18,0	22	-	-	0,6	PHP 3SPZ71TB	
			75	6	1210	79,0	11	32	40	48	15,0	25	-	-	0,7	PHP 3SPZ75TB	
			80	6	1210	84,0	11	32	40	51	15,0	25	-	-	0,7	PHP 3SPZ80TB	
				85	6	1610	89,0	14	42	40	60	15,0	25	-	-	0,8	PHP 3SPZ85TB
				90	6	1610	94,0	14	42	40	61	15,0	25	-	-	0,9	PHP 3SPZ90TB
				95	6	1610	99,0	14	42	40	66	15,0	25	-	-	1,0	PHP 3SPZ95TB
				100	6	1610	104,0	14	42	40	71	15,0	25	-	-	1,1	PHP 3SPZ100TB
				106	6	1610	110,0	14	42	40	78	15,0	25	-	-	1,4	PHP 3SPZ106TB
			112	6	2012	116,0	14	50	40	84	8,0	32	-	-	1,4	PHP 3SPZ112TB	
			118	6	2012	122,0	14	50	40	92	8,0	32	-	-	1,7	PHP 3SPZ118TB	
			125	2	2012	129,0	14	50	40	97	-	32	8,0	-	2,0	PHP 3SPZ125TB	
			132	2	2012	136,0	14	50	40	104	-	32	8,0	-	2,3	PHP 3SPZ132TB	
			140	2	2012	144,0	14	50	40	112	-	32	8,0	-	2,7	PHP 3SPZ140TB	
			150	2	2012	154,0	14	50	40	122	-	32	8,0	-	3,3	PHP 3SPZ150TB	
			160	2	2012	164,0	14	50	40	132	-	32	8,0	-	3,9	PHP 3SPZ160TB	
			170	3	2012	174,0	14	50	40	141	4,0	32	4,0	-	3,2	PHP 3SPZ170TB	
			180	7	2012	184,0	14	50	40	152	-	32	8,0	100	3,4	PHP 3SPZ180TB	
			190	7	2012	194,0	14	50	40	161	4,0	32	4,0	100	3,4	PHP 3SPZ190TB	
			200	5	2012	204,0	14	50	40	172	4,0	32	4,0	100	3,9	PHP 3SPZ200TB	
			224	5	2012	228,0	14	50	40	196	4,0	32	4,0	100	5,4	PHP 3SPZ224TB	
			250	5	2012	254,0	14	50	40	222	4,0	32	4,0	100	6,4	PHP 3SPZ250TB	
			280	4	2517	284,0	16	60	40	252	2,5	45	2,5	120	8,3	PHP 3SPZ280TB	
			315	4	2517	319,0	16	60	40	287	2,5	45	2,5	120	10,1	PHP 3SPZ315TB	
			355	4	2517	359,0	16	60	40	326	2,5	45	2,5	120	11,7	PHP 3SPZ355TB	
			400	4	2517	404,0	16	60	40	371	2,5	45	2,5	120	13,3	PHP 3SPZ400TB	
			450	4	2517	454,0	16	60	40	421	2,5	45	2,5	120	14,6	PHP 3SPZ450TB	
		500	4	2517	504,0	16	60	40	471	2,5	45	2,5	120	15,8	PHP 3SPZ500TB		
		630	4	3020	634,0	25	75	40	601	5,5	45	2,5	120	17,0	PHP 3SPZ630TB		
		800	4	3020	804,0	25	75	40	771	5,5	51	2,5	150	33,0	PHP 3SPZ800TB		
SPZ	4	63	6	1108	67,0	9	28	52	38	30,0	22	-	-	0,5	PHP 4SPZ63TB		
		67	6	1108	71,0	9	28	52	41	30,0	22	-	-	0,6	PHP 4SPZ67TB		
		71	6	1108	75,0	9	28	52	45	30,0	22	-	-	0,7	PHP 4SPZ71TB		
		75	6	1210	79,0	11	32	52	46	27,0	25	-	-	0,8	PHP 4SPZ75TB		
		80	6	1210	84,0	11	32	52	51	27,0	25	-	-	0,9	PHP 4SPZ80TB		
				85	6	1610	89,0	14	42	52	60	27,0	25	-	-	1,0	PHP 4SPZ85TB
				90	6	1610	94,0	14	42	52	61	27,0	25	-	-	1,1	PHP 4SPZ90TB
				95	6	1610	99,0	14	42	52	66	27,0	25	-	-	1,3	PHP 4SPZ95TB
				100	6	1610	104,0	14	42	52	72	27,0	25	-	-	1,4	PHP 4SPZ100TB
				106	6	1610	110,0	14	42	52	80	27,0	25	-	-	1,6	PHP 4SPZ106TB
			112	6	2012	116,0	14	50	52	86	20,0	32	-	-	1,7	PHP 4SPZ112TB	
			118	6	2012	122,0	14	50	52	92	20,0	32	-	-	2,0	PHP 4SPZ118TB	
			125	2	2012	129,0	14	50	52	99	-	32	20,0	-	2,3	PHP 4SPZ125TB	

* Mass does not include bushings.
Non-functional dimensions may vary slightly.

Wedge belt pulleys
SPZ taper bushed

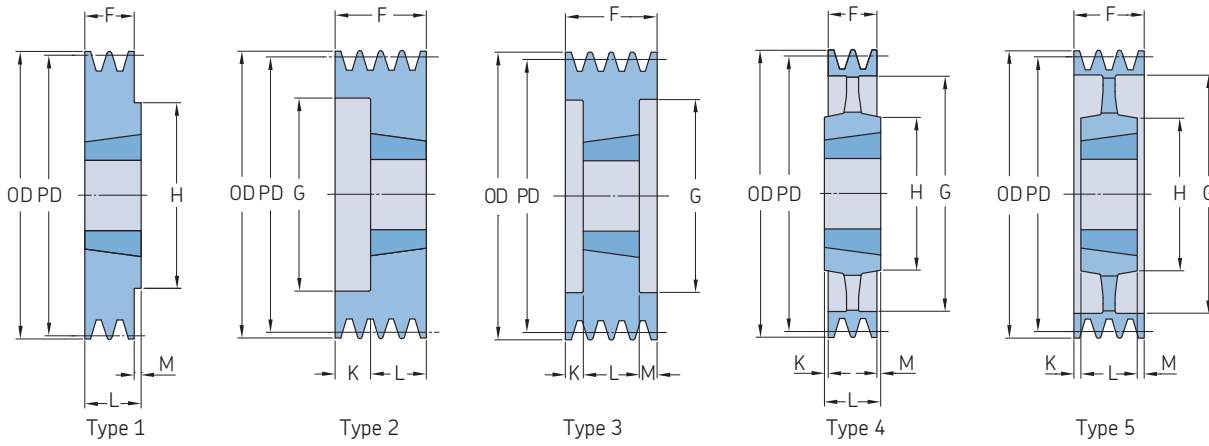

Section	Number of grooves	Pitch diameter PD	Pulley type	Bushing number	Dimensions									Mass*	Designation	
					Outer diameter OD	B Min.	Max.	F	G	K	L	M	H			
		mm			mm									kg		
SPZ	4	132	2	2012	136,0	14	50	52	104	-	32	20,0	-	2,6	PHP 4SPZ132TB	
		140	2	2012	144,0	14	50	52	112	-	32	20,0	-	3,1	PHP 4SPZ140TB	
		150	2	2517	154,0	16	60	52	122	-	45	7,0	-	3,8	PHP 4SPZ150TB	
		160	2	2517	164,0	16	60	52	132	-	45	7,0	-	4,6	PHP 4SPZ160TB	
		170	2	2517	174,0	16	65	52	141	-	45	7,0	-	5,5	PHP 4SPZ170TB	
		180	2	2517	184,0	16	60	52	152	-	45	7,0	-	6,3	PHP 4SPZ180TB	
	4	190	3	2517	194,0	16	65	52	161	3,5	45	3,5	-	5,3	PHP 4SPZ190TB	
		200	7	2517	204,0	16	60	52	172	3,5	45	3,5	120	5,4	PHP 4SPZ200TB	
		224	5	2517	228,0	16	60	52	196	3,5	45	3,5	120	7,0	PHP 4SPZ224TB	
		250	5	2517	254,0	16	60	52	222	3,5	45	3,5	120	8,0	PHP 4SPZ250TB	
		280	5	2517	284,0	16	60	52	252	3,5	45	3,5	120	9,5	PHP 4SPZ280TB	
		315	5	2517	319,0	16	60	52	287	3,5	45	3,5	120	12,1	PHP 4SPZ315TB	
		355	5	2517	359,0	16	60	52	326	3,5	45	3,5	120	12,8	PHP 4SPZ355TB	
		400	5	2517	404,0	16	60	52	371	3,5	45	3,5	120	13,6	PHP 4SPZ400TB	
		450	5	3020	454,0	25	75	52	421	0,5	51	0,5	150	14,5	PHP 4SPZ450TB	
		500	5	3020	504,0	25	75	52	471	0,5	51	0,5	150	17,3	PHP 4SPZ500TB	
		630	4	3030	634,0	35	75	52	601	12,0	76	12,0	150	23,0	PHP 4SPZ630TB	
		800	4	3030	804,0	35	75	52	771	12,0	76	12,0	150	36,0	PHP 4SPZ800TB	
SPZ	5	85	6	1610	89,0	14	42	64	60	39,0	25	-	-	1,3	PHP 5SPZ85TB	
		90	6	1610	94,0	14	42	64	61	39,0	25	-	-	1,3	PHP 5SPZ90TB	
		95	6	1610	99,0	14	42	64	66	39,0	25	-	-	1,5	PHP 5SPZ95TB	
		100	6	2012	104,0	14	50	64	72	32,0	32	-	-	1,6	PHP 5SPZ100TB	
		106	6	2012	110,0	14	50	64	78	32,0	32	-	-	1,8	PHP 5SPZ106TB	
		112	6	2012	116,0	14	50	64	84	32,0	32	-	-	2,0	PHP 5SPZ112TB	
	5	118	6	2012	122,0	14	50	64	90	32,0	32	-	-	2,3	PHP 5SPZ118TB	
		125	6	2012	129,0	14	50	64	97	32,0	32	-	-	2,7	PHP 5SPZ125TB	
		132	6	2517	136,0	16	60	64	104	19,0	45	-	-	2,8	PHP 5SPZ132TB	
		140	2	2517	144,0	16	60	64	112	-	45	19,0	-	3,4	PHP 5SPZ140TB	
		150	2	2517	154,0	16	60	64	122	-	45	19,0	-	4,3	PHP 5SPZ150TB	
		160	2	2517	164,0	16	60	64	132	-	45	19,0	-	5,1	PHP 5SPZ160TB	
	5	170	2	2517	174,0	16	60	64	141	-	45	19,0	-	5,7	PHP 5SPZ170TB	
		180	2	2517	184,0	16	60	64	152	-	45	19,0	-	6,8	PHP 5SPZ180TB	
		190	3	2517	194,0	16	60	64	161	9,5	45	9,5	-	7,8	PHP 5SPZ190TB	
		200	5	2517	204,0	16	60	64	172	9,5	45	9,5	-	8,8	PHP 5SPZ200TB	
		224	5	2517	228,0	16	60	64	196	9,5	45	9,5	120	8,8	PHP 5SPZ224TB	
		250	5	2517	254,0	16	60	64	222	9,5	45	9,5	120	9,0	PHP 5SPZ250TB	
	5	280	5	2517	284,0	16	60	64	252	9,5	45	9,5	120	11,0	PHP 5SPZ280TB	
		315	5	2517	319,0	16	60	64	287	9,5	45	9,5	120	13,3	PHP 5SPZ315TB	
		355	5	2517	359,0	16	60	64	326	9,5	45	9,5	120	13,0	PHP 5SPZ355TB	
		400	5	3020	404,0	25	75	64	371	6,5	51	6,5	150	15,6	PHP 5SPZ400TB	
		450	5	3020	454,0	25	75	64	421	6,5	51	6,5	150	19,0	PHP 5SPZ450TB	
		500	4	3030	504,0	35	75	64	471	6,0	51	6,0	150	22,6	PHP 5SPZ500TB	
5	630	4	3030	634,0	35	75	64	601	6,0	51	6,0	150	29,0	PHP 5SPZ630TB		
	800	4	3535	804,0	35	90	64	771	12,5	89	12,5	170	44,1	PHP 5SPZ800TB		
	SPZ	6	85	6	1610	89,0	14	42	76	61	51,0	25	-	-	1,3	PHP 6SPZ85TB
			90	6	1610	94,0	14	42	76	61	51,0	25	-	-	1,5	PHP 6SPZ90TB
			95	6	1610	99,0	14	42	76	66	51,0	25	-	-	1,7	PHP 6SPZ95TB
			100	6	2012	104,0	14	50	76	72	44,0	32	-	-	1,9	PHP 6SPZ100TB
106			6	2012	110,0	14	50	76	78	44,0	32	-	-	2,0	PHP 6SPZ106TB	
112			6	2012	116,0	14	50	76	84	44,0	32	-	-	2,3	PHP 6SPZ112TB	
6	118	6	2517	122,0	16	60	76	90	31,0	45	-	-	2,3	PHP 6SPZ118TB		
	125	6	2517	129,0	16	60	76	97	31,0	45	-	-	2,7	PHP 6SPZ125TB		
	132	6	2517	136,0	16	60	76	104	31,0	45	-	-	3,2	PHP 6SPZ132TB		

* Mass does not include bushings.
Non-functional dimensions may vary slightly.

Wedge belt pulleys

SPZ taper bushed | SPA taper bushed

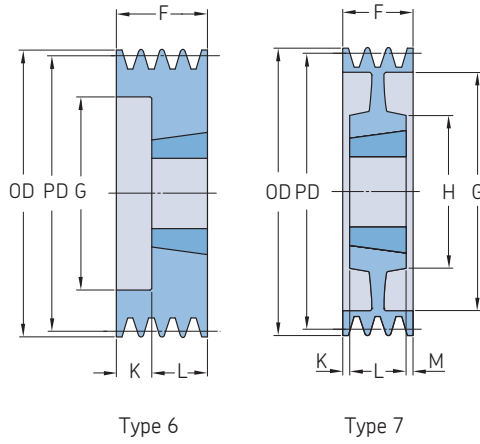

Section	Number of grooves	Pitch diameter PD	Pulley type	Bushing number	Dimensions									Mass*	Designation		
					Outer diameter OD	B Min. Max.	F	G	K	L	M	H					
					mm									kg			
SPZ	6	140	2	2517	144,0	16	60	76	112	–	45	31,0	–	3,8	PHP 6SPZ140TB		
		150	2	2517	154,0	16	60	76	122	–	45	31,0	–	4,6	PHP 6SPZ150TB		
		160	2	2517	164,0	16	60	76	132	–	45	31,0	–	5,5	PHP 6SPZ160TB		
		170	2	2517	174,0	16	65	76	141	–	45	31,0	–	6,5	PHP 6SPZ170TB		
		180	3	2517	184,0	16	60	76	152	15,5	45	15,5	–	7,3	PHP 6SPZ180TB		
		190	3	2517	194,0	16	65	76	161	15,5	45	15,5	120	8,4	PHP 6SPZ190TB		
	SPZ	8	200	3	2517	204,0	16	60	76	172	15,5	45	15,5	120	9,4	PHP 6SPZ200TB	
			224	5	2517	228,0	16	60	76	196	15,5	45	15,5	120	9,7	PHP 6SPZ224TB	
			250	5	2517	254,0	16	60	76	222	15,5	45	15,5	120	11,8	PHP 6SPZ250TB	
			280	5	2517	284,0	16	60	76	252	15,5	45	15,5	120	12,8	PHP 6SPZ280TB	
			315	5	2517	319,0	16	60	76	287	15,5	45	15,5	120	13,8	PHP 6SPZ315TB	
			355	5	2517	359,0	16	60	76	326	15,5	45	15,5	125	15,0	PHP 6SPZ355TB	
		SPZ	8	400	5	3030	404,0	25	75	76	371	–	76	–	150	18,3	PHP 6SPZ400TB
				450	5	3030	454,0	25	75	76	421	–	76	–	150	21,5	PHP 6SPZ450TB
				500	5	3030	504,0	25	75	76	471	–	76	–	150	24,6	PHP 6SPZ500TB
				630	4	3535	634,0	35	90	76	601	6,5	89	6,5	170	35,0	PHP 6SPZ630TB
				800	4	3535	804,0	35	90	76	771	6,5	89	6,5	170	57,9	PHP 6SPZ800TB
				140	3	2517	144,0	16	60	100	112	27,5	45	27,5	–	4,0	PHP 8SPZ140TB
SPA	1	150	3	2517	154,0	16	60	100	122	27,5	45	27,5	–	5,1	PHP 8SPZ150TB		
		160	3	2517	164,0	16	60	100	132	27,5	45	27,5	–	5,6	PHP 8SPZ160TB		
		180	3	2517	184,0	16	60	100	152	27,5	45	27,5	–	7,1	PHP 8SPZ180TB		
		200	3	3020	204,0	25	75	100	171	24,5	51	24,5	–	9,3	PHP 8SPZ200TB		
		224	3	3020	228,0	25	75	100	195	24,5	51	24,5	–	11,8	PHP 8SPZ224TB		
		250	5	3020	254,0	25	75	100	221	24,5	51	24,5	150	10,5	PHP 8SPZ250TB		
	SPA	1	280	5	3020	284,0	25	75	100	252	24,5	51	24,5	150	10,8	PHP 8SPZ280TB	
			355	5	3030	359,0	35	75	100	326	12,0	76	12,0	150	16,0	PHP 8SPZ355TB	
			400	5	3030	404,0	35	75	100	371	12,0	76	12,0	150	18,2	PHP 8SPZ400TB	
			450	5	3535	454,0	35	90	100	421	5,5	89	5,5	170	24,0	PHP 8SPZ450TB	
			63	1	1108	68,5	9	25	20	–	–	22	2,0	62	0,8	PHP 1SPA63TB	
			67	1	1108	72,5	9	28	20	–	–	22	2,0	62	0,5	PHP 1SPA67TB	
SPA	1	71	1	1108	76,5	9	28	20	–	–	22	2,0	62	0,5	PHP 1SPA71TB		
		75	1	1108	80,5	9	28	22	–	–	22	2,0	62	0,4	PHP 1SPA75TB		
		80	1	1210	85,5	11	32	20	–	–	25	5,0	75	0,5	PHP 1SPA80TB		
		85	1	1210	90,5	11	32	20	–	–	25	5,0	75	0,6	PHP 1SPA85TB		
		90	1	1210	95,5	11	32	20	–	–	25	5,0	75	0,7	PHP 1SPA90TB		
		95	1	1210	100,5	11	32	20	–	–	25	5,0	75	0,9	PHP 1SPA95TB		
	SPA	1	100	1	1610	105,5	14	42	20	–	–	25	5,0	80	0,8	PHP 1SPA100TB	
			106	1	1610	111,5	14	42	20	–	–	25	5,0	80	0,9	PHP 1SPA106TB	
			112	1	1610	117,5	14	42	20	–	–	25	5,0	80	1,1	PHP 1SPA112TB	
			118	1	1610	123,5	14	42	20	–	–	25	5,0	80	1,2	PHP 1SPA118TB	
			125	1	1610	130,5	14	42	20	–	–	25	5,0	80	1,4	PHP 1SPA125TB	
			132	1	1610	137,5	14	42	20	–	–	25	5,0	80	1,6	PHP 1SPA132TB	
		SPA	1	140	1	1610	145,5	14	42	20	–	–	25	5,0	80	1,8	PHP 1SPA140TB
				150	1	1610	155,5	14	42	20	–	–	25	5,0	80	2,1	PHP 1SPA150TB
				160	1	1610	165,5	14	42	20	–	–	25	5,0	80	2,4	PHP 1SPA160TB
				170	1	1610	175,5	14	42	20	–	–	25	5,0	80	1,1	PHP 1SPA170TB
				180	4	1610	185,5	14	42	20	145	–	25	5,0	92	2,3	PHP 1SPA180TB
				190	4	1610	195,5	14	42	20	156	–	25	5,0	92	2,7	PHP 1SPA190TB
SPA	4	200	4	2012	205,5	14	50	20	165	–	32	12,0	108	2,3	PHP 1SPA200TB		
		212	4	2012	217,5	14	50	20	177	–	32	12,0	110	3,5	PHP 1SPA212TB		
		224	4	2012	229,5	14	50	20	189	–	32	12,0	112	4,0	PHP 1SPA224TB		
		250	4	2012	255,5	14	50	20	215	6,0	32	6,0	112	4,8	PHP 1SPA250TB		
		280	4	2012	285,5	14	50	20	245	–	32	12,0	112	6,3	PHP 1SPA280TB		

* Mass does not include bushings.
Non-functional dimensions may vary slightly.

Wedge belt pulleys
SPA taper bushed

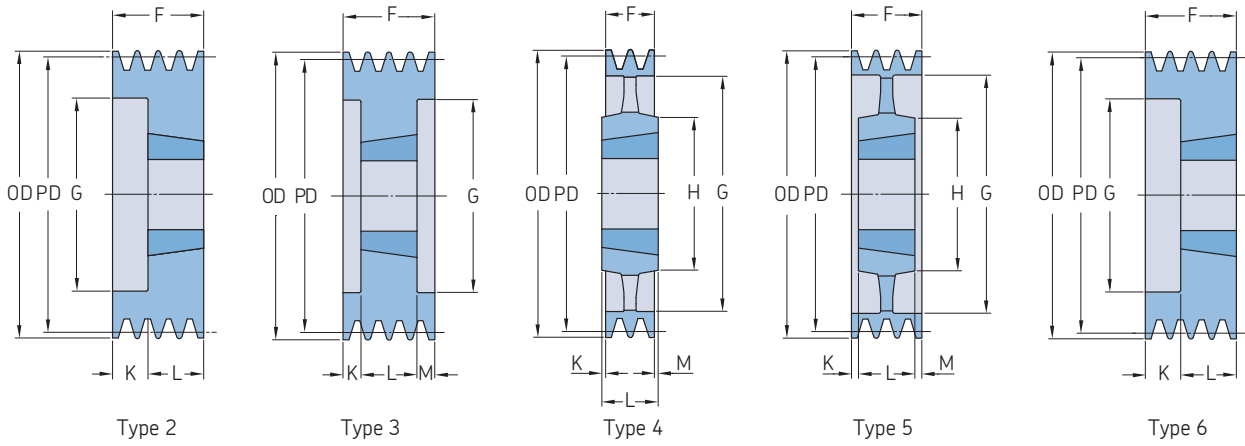

Section	Number of grooves	Pitch diameter PD	Pulley type	Bushing number	Dimensions		B Min.	Max.	F	G	K	L	M	H	Mass*	Designation
					Outer diameter OD											
mm																
SPA	1	315	4	2012	320,5	14	50	20	280	-	32	12,0	112	7,2	PHP 1SPA315TB	
		355	4	2012	360,5	14	50	20	320	-	32	12,0	112	7,6	PHP 1SPA355TB	
		400	4	2012	405,5	14	50	20	365	-	32	12,0	112	7,9	PHP 1SPA400TB	
		450	4	2012	455,5	16	60	20	415	-	32	12,0	112	8,4	PHP 1SPA450TB	
		500	4	2517	505,5	16	60	20	465	-	45	12,0	112	9,4	PHP 1SPA500TB	
		630	4	2517	635,5	16	60	20	595	-	45	12,0	112	13,1	PHP 1SPA630TB	
	SPA	2	63	6	1008	68,5	9	28	35	33	13,0	22	-	-	0,6	PHP 2SPA63TB
			67	6	1108	72,5	9	28	35	37	13,0	22	-	-	0,4	PHP 2SPA67TB
			71	6	1108	76,5	9	28	35	40	13,0	22	-	-	0,5	PHP 2SPA71TB
			75	6	1108	80,5	9	28	35	44	13,0	25	-	-	0,7	PHP 2SPA75TB
80			6	1210	85,5	11	32	35	47	10,0	25	-	-	0,6	PHP 2SPA80TB	
85			6	1210	90,5	11	32	35	50	10,0	25	-	-	0,7	PHP 2SPA85TB	
90			6	1610	95,5	14	42	35	60	10,0	25	-	-	0,7	PHP 2SPA90TB	
95			6	1610	100,5	14	42	35	64	10,0	25	-	-	0,9	PHP 2SPA95TB	
100			6	1610	105,5	14	42	35	70	10,0	25	-	-	1,1	PHP 2SPA100TB	
106			6	1610	111,5	14	42	35	76	10,0	25	-	-	1,2	PHP 2SPA106TB	
112			6	1610	117,5	14	42	35	80	10,0	25	-	-	1,4	PHP 2SPA112TB	
118			6	1610	123,5	14	42	35	86	10,0	25	-	-	1,6	PHP 2SPA118TB	
125			6	1610	130,5	14	42	35	90	10,0	25	-	-	1,9	PHP 2SPA125TB	
132			6	2012	137,5	14	50	35	98	3,0	32	-	-	2,1	PHP 2SPA132TB	
140			6	2012	145,5	14	50	35	106	3,0	32	-	-	2,6	PHP 2SPA140TB	
150			6	2012	155,5	14	50	35	116	3,0	32	-	-	3,2	PHP 2SPA150TB	
160			6	2012	165,5	14	50	35	125	3,0	32	-	-	3,8	PHP 2SPA160TB	
170			6	2012	175,5	14	50	35	135	3,0	32	-	-	4,5	PHP 2SPA170TB	
180			7	2012	185,5	14	50	35	148	2,0	32	2,0	100	5,2	PHP 2SPA180TB	
190			7	2012	195,5	14	50	35	158	2,0	32	2,0	100	4,4	PHP 2SPA190TB	
200			8	2517	205,5	16	60	35	165	5,0	45	5,0	120	4,9	PHP 2SPA200TB	
212			4	2517	217,5	16	65	35	177	5,0	45	5,0	120	5,8	PHP 2SPA212TB	
224			4	2517	229,5	16	60	35	189	-	45	10,0	120	6,6	PHP 2SPA224TB	
250			4	2517	255,5	16	60	35	215	5,0	45	5,0	120	6,8	PHP 2SPA250TB	
280			4	2517	285,5	16	60	35	245	-	45	10,0	120	8,3	PHP 2SPA280TB	
315			4	2517	320,5	16	60	35	280	-	45	10,0	120	10,2	PHP 2SPA315TB	
355			4	2517	360,5	16	60	35	320	-	45	10,0	120	10,5	PHP 2SPA355TB	
400			4	2517	405,5	16	60	35	365	-	45	10,0	120	11,3	PHP 2SPA400TB	
450	4	2517	455,5	16	60	35	465	-	45	10,0	120	15,0	PHP 2SPA450TB			
500	4	2517	505,5	16	60	35	525	-	51	16,0	150	18,7	PHP 2SPA500TB			
	630	4	3020	635,5	25	75	35	595	8,0	51	8,0	150	22,0	PHP 2SPA630TB		
SPA	3	71	6	1108	76,5	9	28	50	40	28,0	22	-	-	0,7	PHP 3SPA71TB	
		75	6	1108	80,5	9	28	50	44	28,0	25	-	-	0,8	PHP 3SPA75TB	
		80	6	1210	85,5	11	32	50	47	25,0	25	-	-	0,9	PHP 3SPA80TB	
		85	6	1210	90,5	11	32	50	50	25,0	25	-	-	1,0	PHP 3SPA85TB	
		90	6	1610	95,5	14	42	50	60	25,0	25	-	-	1,0	PHP 3SPA90TB	
		95	6	1610	100,5	14	42	50	64	25,0	25	-	-	1,2	PHP 3SPA95TB	
		100	2	1610	105,5	14	42	50	70	-	25	25,0	-	1,3	PHP 3SPA100TB	
		106	2	1610	111,5	14	42	50	76	-	25	25,0	-	1,6	PHP 3SPA106TB	
		112	6	2012	117,5	14	50	50	83	18,0	32	-	-	1,6	PHP 3SPA112TB	
		118	2	2012	123,5	14	50	50	86	-	32	18,0	-	1,9	PHP 3SPA118TB	
		125	2	2012	130,5	14	50	50	92	-	32	18,0	-	2,3	PHP 3SPA125TB	
		132	2	2012	137,5	14	50	50	98	-	32	18,0	-	2,6	PHP 3SPA132TB	
		140	6	2517	145,5	16	60	50	106	5,0	45	-	-	2,9	PHP 3SPA140TB	
		150	6	2517	155,5	16	60	50	116	5,0	45	-	-	3,7	PHP 3SPA150TB	
		160	6	2517	165,5	16	60	50	126	5,0	45	-	-	4,5	PHP 3SPA160TB	

* Mass does not include bushings.
Non-functional dimensions may vary slightly.

Wedge belt pulleys
SPA taper bushed

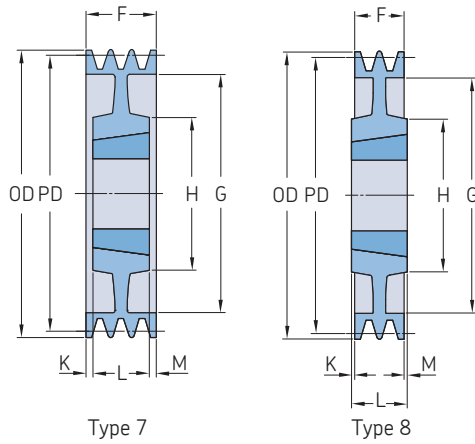

Section	Number of grooves	Pitch diameter PD	Pulley type	Bushing number	Dimensions		F	G	K	L	M	H	Mass*	Designation	
					Outer diameter OD	B Min. Max.									
													kg	-	
SPA	3	170	6	2517	175,5	16	60	50	138	5,0	45	-	-	5,0	PHP 3SPA170TB
		180	6	2517	185,5	16	60	50	146	5,0	45	-	-	6,2	PHP 3SPA180TB
		190	6	2517	195,5	16	60	50	158	5,0	45	-	-	7,0	PHP 3SPA190TB
		200	7	2517	205,5	16	60	50	165	2,5	45	2,5	120	5,6	PHP 3SPA200TB
		212	5	2517	217,5	16	60	50	177	2,5	45	2,5	120	6,6	PHP 3SPA212TB
		224	5	2517	229,5	16	60	50	189	2,5	45	2,5	120	7,5	PHP 3SPA224TB
		250	5	2517	255,5	16	60	50	215	2,5	45	2,5	120	8,6	PHP 3SPA250TB
		280	5	2517	285,5	16	60	50	245	2,5	45	2,5	120	10,0	PHP 3SPA280TB
		315	4	3020	320,5	25	75	50	280	0,5	51	0,5	160	12,8	PHP 3SPA315TB
		355	4	3020	360,5	25	75	50	320	0,5	51	0,5	150	13,4	PHP 3SPA355TB
		400	4	3020	405,5	25	75	50	365	-	51	1,0	150	15,9	PHP 3SPA400TB
		450	4	3020	455,5	25	75	50	415	-	51	1,0	150	19,3	PHP 3SPA450TB
		500	4	3020	505,5	25	75	50	465	-	51	1,0	150	22,6	PHP 3SPA500TB
		560	4	3020	565,5	25	75	50	525	-	51	1,0	150	23,5	PHP 3SPA560TB
		630	4	3020	635,5	25	75	50	595	-	51	1,0	150	27,5	PHP 3SPA630TB
		800	4	3535	805,5	35	90	50	765	19,5	89	19,5	170	40,8	PHP 3SPA800TB
	1 000	4	3535	1 005,5	35	90	50	965	19,5	89	19,5	178	50,0	PHP 3SPA1000TB	
SPA	4	90	6	1615	95,5	14	42	65	64	27,0	38	-	-	1,2	PHP 4SPA90TB
		95	6	1615	100,5	14	42	65	64	27,0	38	-	-	1,4	PHP 4SPA95TB
		100	2	1615	105,5	14	42	65	70	-	38	27,0	-	1,6	PHP 4SPA100TB
		106	6	2012	111,5	14	50	65	76	33,0	32	-	-	1,7	PHP 4SPA106TB
		112	6	2012	117,5	14	50	65	80	33,0	32	-	-	2,0	PHP 4SPA112TB
		118	2	2012	123,5	14	50	65	86	-	32	33,0	-	2,3	PHP 4SPA118TB
		125	2	2012	130,5	14	50	65	92	-	32	33,0	-	2,7	PHP 4SPA125TB
		132	2	2517	137,5	16	60	65	98	-	45	20,0	-	2,9	PHP 4SPA132TB
		140	2	2517	145,5	16	60	65	106	-	45	20,0	-	3,5	PHP 4SPA140TB
		150	2	2517	155,5	16	60	65	116	-	45	20,0	-	4,2	PHP 4SPA150TB
		160	2	2517	165,5	16	60	65	126	-	45	20,0	-	5,1	PHP 4SPA160TB
		170	2	2517	175,5	16	60	65	138	-	45	20,0	-	6,0	PHP 4SPA170TB
		180	2	2517	185,5	16	60	65	146	-	45	20,0	-	6,9	PHP 4SPA180TB
		190	2	2517	195,5	16	60	65	158	-	45	20,0	-	7,2	PHP 4SPA190TB
		200	2	3020	205,5	25	75	65	165	-	51	14,0	-	8,4	PHP 4SPA200TB
		212	2	3020	217,5	25	75	65	177	-	51	14,0	-	9,9	PHP 4SPA212TB
		224	2	3020	229,5	25	75	65	189	-	51	14,0	-	11,4	PHP 4SPA224TB
		250	5	3020	255,5	25	75	65	215	7,0	51	7,0	150	10,5	PHP 4SPA250TB
		280	5	3020	285,5	25	75	65	245	7,0	51	7,0	150	11,6	PHP 4SPA280TB
		315	5	3020	320,5	25	75	65	280	7,0	51	7,0	150	13,8	PHP 4SPA315TB
	355	5	3020	360,5	25	75	65	320	7,0	51	7,0	150	15,8	PHP 4SPA355TB	
	400	5	3020	405,5	25	75	65	365	7,0	51	7,0	150	17,7	PHP 4SPA400TB	
	450	5	3020	455,5	25	75	65	415	7,0	51	7,0	150	23,2	PHP 4SPA450TB	
	500	5	3020	505,5	25	75	65	465	7,0	51	7,0	150	27,4	PHP 4SPA500TB	
	560	4	3535	565,5	35	90	65	525	12,0	89	12,0	170	30,5	PHP 4SPA560TB	
	630	4	4545	635,5	35	90	65	595	12,0	89	12,0	170	34,1	PHP 4SPA630TB	
	800	4	3535	805,5	35	90	65	765	12,0	89	12,0	170	50,8	PHP 4SPA800TB	
	1 000	4	4040	1 005,5	40	100	65	965	18,5	102	18,5	216	62,0	PHP 4SPA1000TB	
SPA	5	100	2	1615	105,5	14	42	80	70	-	38	42,0	-	1,9	PHP 5SPA100TB
		106	6	2012	111,5	14	50	80	76	48,0	32	-	-	2,1	PHP 5SPA106TB
		112	6	2012	117,5	14	50	80	80	48,0	32	-	-	2,4	PHP 5SPA112TB
		118	2	2012	123,5	14	50	80	86	-	32	48,0	-	2,7	PHP 5SPA118TB
		125	3	2012	130,5	14	50	80	92	24,0	32	24,0	-	3,1	PHP 5SPA125TB
		132	3	2517	137,5	16	60	80	98	17,5	45	17,5	-	3,2	PHP 5SPA132TB
		140	3	2517	145,5	16	60	80	106	17,5	45	17,5	-	3,9	PHP 5SPA140TB
150	3	2517	155,5	16	60	80	116	17,5	45	17,5	-	4,7	PHP 5SPA150TB		

* Mass does not include bushings.
Non-functional dimensions may vary slightly.

Wedge belt pulleys

SPA taper bushed | SPB taper bushed

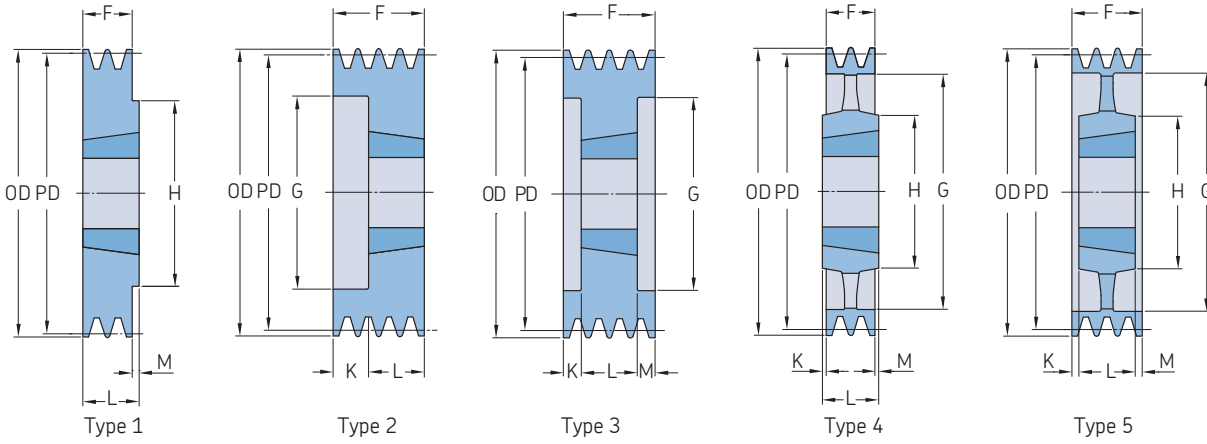

Section	Number of grooves	Pitch diameter PD	Pulley type	Bushing number	Dimensions		Max.	F	G	K	L	M	H	Mass*	Designation		
					Outer diameter OD	B Min.											
														kg	-		
SPA	5	160	3	2517	165,5	16	60	80	126	17,5	45	17,5	-	5,6	PHP 5SPA160TB		
		170	3	2517	175,5	16	60	80	146	17,5	45	17,5	-	6,2	PHP 5SPA170TB		
		180	3	3020	185,5	25	75	80	165	14,5	51	14,5	-	6,8	PHP 5SPA180TB		
		190	2	3020	195,5	25	75	80	189	-	51	29,0	-	7,4	PHP 5SPA190TB		
		200	3	3020	205,5	25	75	80	215	14,5	51	14,5	-	9,1	PHP 5SPA200TB		
			212	2	3020	217,5	25	75	80	245	-	51	29,0	-	10,7	PHP 5SPA212TB	
			224	2	3020	229,5	25	75	80	280	-	51	29,0	-	12,3	PHP 5SPA224TB	
			250	7	3020	255,5	25	75	80	215	14,5	51	14,5	150	11,7	PHP 5SPA250TB	
			280	4	3535	285,5	35	90	80	245	4,5	89	4,5	170	17,4	PHP 5SPA280TB	
			315	4	3535	320,5	35	90	80	280	4,5	89	4,5	170	20,0	PHP 5SPA315TB	
			355	4	3535	360,5	35	90	80	320	4,5	89	4,5	170	22,8	PHP 5SPA355TB	
			400	4	3535	405,5	35	90	80	365	4,5	89	4,5	170	24,8	PHP 5SPA400TB	
			450	4	3535	455,5	35	90	80	415	4,5	89	4,5	170	28,5	PHP 5SPA450TB	
			500	4	3535	505,5	35	90	80	465	4,5	89	4,5	170	31,7	PHP 5SPA500TB	
			560	4	3535	565,5	35	90	80	525	4,5	89	4,5	170	35,0	PHP 5SPA560TB	
			630	4	3535	635,5	35	90	80	595	4,5	89	4,5	170	42,0	PHP 5SPA630TB	
			800	4	4040	805,5	40	100	80	765	11,0	102	11,0	216	60,0	PHP 5SPA800TB	
			1 000	4	4545	1 005,5	55	120	80	965	17,0	114	17,0	225	70,0	PHP 5SPA1000TB	
SPA	6	100	3	1610	105,5	14	42	95	70	30,0	38	40,0	-	2,2	PHP 6SPA100TB		
		106	6	2012	111,5	14	50	95	76	63,0	32	-	-	2,5	PHP 6SPA106TB		
		112	6	2012	117,5	14	50	95	80	63,0	32	-	-	2,8	PHP 6SPA112TB		
		118	6	2012	123,5	14	50	95	86	63,0	32	-	-	3,1	PHP 6SPA118TB		
		125	3	2012	130,5	14	50	95	92	31,5	32	31,5	-	3,7	PHP 6SPA125TB		
				132	3	2517	137,5	16	60	95	98	25,0	45	25,0	-	3,6	PHP 6SPA132TB
				140	3	2517	145,5	16	60	95	106	25,0	45	25,0	-	4,5	PHP 6SPA140TB
				150	3	2517	155,5	16	60	95	116	25,0	45	25,0	-	5,3	PHP 6SPA150TB
				160	3	2517	165,5	16	60	95	126	25,0	45	25,0	-	6,3	PHP 6SPA160TB
				170	3	3020	175,5	25	75	95	135	22,0	51	22,0	-	6,3	PHP 6SPA170TB
			180	3	3020	185,5	25	75	95	146	22,0	51	22,0	-	7,5	PHP 6SPA180TB	
			190	3	3020	195,5	25	75	95	155	22,0	51	22,0	-	8,6	PHP 6SPA190TB	
			200	3	3020	205,5	25	75	95	165	22,0	51	22,0	-	9,9	PHP 6SPA200TB	
			212	3	3020	217,5	25	75	95	177	22,0	51	22,0	-	11,6	PHP 6SPA212TB	
			224	3	3020	229,5	25	75	95	189	22,0	51	22,0	-	13,2	PHP 6SPA224TB	
			250	7	3020	255,5	25	75	95	215	22,0	51	22,0	150	12,5	PHP 6SPA250TB	
			280	5	3535	285,5	35	90	95	245	3,0	89	3,0	170	19,0	PHP 6SPA280TB	
			315	5	3535	320,5	35	90	95	280	3,0	89	3,0	170	21,1	PHP 6SPA315TB	
			355	5	3535	360,5	35	90	95	320	3,0	89	3,0	170	23,5	PHP 6SPA355TB	
			400	5	3535	405,5	35	90	95	365	3,0	89	3,0	170	26,0	PHP 6SPA400TB	
		450	5	3535	455,5	35	90	95	415	3,0	89	3,0	170	30,0	PHP 6SPA450TB		
		500	5	3535	505,5	35	90	95	465	3,0	89	3,0	170	34,0	PHP 6SPA500TB		
		560	5	3535	565,5	35	90	95	525	3,0	89	3,0	170	39,0	PHP 6SPA560TB		
		630	4	4040	635,5	40	100	95	595	3,5	102	3,5	216	53,5	PHP 6SPA630TB		
		800	4	4040	805,5	40	100	95	765	3,5	102	3,5	216	70,0	PHP 6SPA800TB		
		1 000	4	4545	1 005,5	55	120	95	965	9,5	114	9,5	225	85,5	PHP 6SPA1000TB		
SPB	1	100	1	1610	107,0	14	42	25	-	-	25	-	-	0,8	PHP 1SPB100TB		
		106	1	1610	113,0	14	42	25	-	-	25	-	-	1,0	PHP 1SPB106TB		
		112	1	1610	119,0	14	42	25	-	-	25	-	-	1,2	PHP 1SPB112TB		
		118	1	1610	125,0	14	42	25	-	-	25	-	-	1,5	PHP 1SPB118TB		
		125	1	1610	132,0	14	42	25	-	-	25	-	-	1,5	PHP 1SPB125TB		
			132	1	1610	139,0	14	42	25	-	-	25	-	-	1,8	PHP 1SPB132TB	
			140	1	1610	147,0	14	42	25	-	-	25	-	-	2,1	PHP 1SPB140TB	
			150	1	1610	157,0	14	42	25	-	-	25	-	-	2,5	PHP 1SPB150TB	
			160	1	1610	167,0	14	42	25	-	-	25	-	-	2,9	PHP 1SPB160TB	

* Mass does not include bushings.
Non-functional dimensions may vary slightly.

Wedge belt pulleys
SPB taper bushed

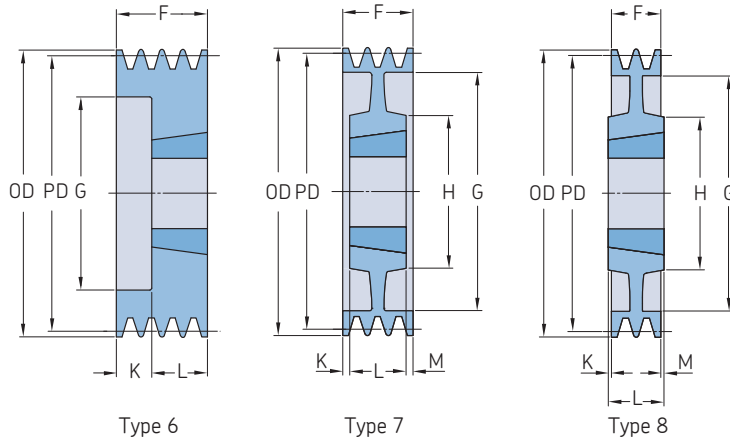

Section	Number of grooves	Pitch diameter PD	Pulley type	Bushing number	Dimensions			F	G	K	L	M	H	Mass*	Designation		
					Outer diameter OD	B Min.	Max.										
		mm	-	-	mm										kg	-	
SPB	1	170	1	1610	177,0	14	42	25	-	-	25	-	-	3,0	PHP 1SPB170TB		
		180	7	1610	187,0	14	42	25	137	-	25	-	80	3,8	PHP 1SPB180TB		
		190	8	2012	197,0	14	50	25	147	3,5	32	3,5	100	4,4	PHP 1SPB190TB		
		200	4	2012	207,0	14	50	25	157	3,5	32	3,5	104	4,0	PHP 1SPB200TB		
		212	4	2012	219,0	14	50	25	169	3,5	32	3,5	104	5,2	PHP 1SPB212TB		
		224	4	2012	231,0	14	50	25	181	3,5	32	3,5	104	5,2	PHP 1SPB224TB		
	SPB	2	236	4	2012	243,0	14	50	25	193	3,5	32	3,5	104	5,4	PHP 1SPB236TB	
			250	4	2012	257,0	14	50	25	207	3,5	32	3,5	104	6,2	PHP 1SPB250TB	
			280	4	2012	287,0	14	50	25	237	3,5	32	3,5	104	6,5	PHP 1SPB280TB	
			300	4	2012	307,0	14	50	25	258	3,5	32	3,5	104	7,0	PHP 1SPB300TB	
			315	4	2012	322,0	14	50	25	272	3,5	32	3,5	100	7,5	PHP 1SPB315TB	
			335	4	2517	342,0	16	60	25	288	10,0	45	10,0	125	8,5	PHP 1SPB335TB	
		SPB	3	355	4	3020	362,0	25	75	25	312	13,0	51	13,0	146	9,5	PHP 1SPB355TB
				400	4	3020	407,0	25	75	25	357	13,0	51	13,0	146	11,0	PHP 1SPB400TB
				450	4	3020	457,0	25	75	25	407	13,0	51	13,0	150	12,3	PHP 1SPB450TB
				500	4	3020	507,0	25	75	25	457	13,0	51	13,0	150	14,6	PHP 1SPB500TB
				560	4	3020	567,0	25	75	25	517	13,0	51	13,0	150	18,5	PHP 1SPB560TB
				630	4	3020	637,0	25	75	25	587	13,0	51	13,0	150	20,5	PHP 1SPB630TB
SPB	1	100	6	1610	107,0	14	42	44	62	19,0	25	-	-	1,3	PHP 2SPB100TB		
		106	6	1610	113,0	14	42	44	67	19,0	25	-	-	1,5	PHP 2SPB106TB		
		112	6	1610	119,0	14	42	44	72	19,0	25	-	-	1,5	PHP 2SPB112TB		
		118	2	1610	125,0	14	42	44	78	-	25	19,0	-	1,7	PHP 2SPB118TB		
		125	2	2012	132,0	14	50	44	82	-	32	12,0	-	2,0	PHP 2SPB125TB		
		132	2	2012	139,0	14	50	44	89	-	32	12,0	-	2,4	PHP 2SPB132TB		
	SPB	2	140	2	2012	147,0	14	50	44	97	-	32	12,0	-	2,8	PHP 2SPB140TB	
			150	2	2012	157,0	14	50	44	107	-	32	12,0	-	3,3	PHP 2SPB150TB	
			160	2	2012	167,0	14	50	44	117	-	32	12,0	-	4,0	PHP 2SPB160TB	
			170	2	2012	177,0	14	50	44	127	-	32	12,0	-	4,4	PHP 2SPB170TB	
			180	1	2517	187,0	16	60	44	-	-	45	1,0	120	5,5	PHP 2SPB180TB	
			190	1	2517	197,0	16	60	44	-	-	45	1,0	120	6,5	PHP 2SPB190TB	
		SPB	3	200	1	2517	207,0	16	60	44	-	-	45	1,0	120	7,5	PHP 2SPB200TB
				212	8	2517	219,0	16	60	44	169	-	45	1,0	120	7,0	PHP 2SPB212TB
				224	4	2517	231,0	16	60	44	181	-	45	1,0	120	7,7	PHP 2SPB224TB
				236	4	2517	243,0	16	60	44	193	-	45	1,0	120	8,3	PHP 2SPB236TB
				250	4	2517	257,0	16	60	44	207	-	45	1,0	120	8,6	PHP 2SPB250TB
				280	4	2517	287,0	16	60	44	237	-	45	1,0	120	10,1	PHP 2SPB280TB
SPB	4	300	4	2517	307,0	16	60	44	257	-	45	1,0	120	11,0	PHP 2SPB300TB		
		315	4	2517	322,0	16	60	44	272	-	45	1,0	120	12,2	PHP 2SPB315TB		
		335	4	2517	342,0	16	60	44	292	-	45	1,0	120	14,0	PHP 2SPB335TB		
		355	4	3020	362,0	25	75	44	312	3,5	51	3,5	120	15,9	PHP 2SPB355TB		
		400	4	3020	407,0	25	75	44	357	3,5	51	3,5	150	18,3	PHP 2SPB400TB		
		450	4	3020	457,0	25	75	44	407	3,5	51	3,5	150	16,3	PHP 2SPB450TB		
	SPB	5	500	4	3020	507,0	25	75	44	457	3,5	51	3,5	150	18,6	PHP 2SPB500TB	
			560	4	3030	567,0	35	75	44	517	4,0	76	28,0	150	22,5	PHP 2SPB560TB	
			630	4	3030	637,0	35	75	44	587	16,0	76	-	150	25,5	PHP 2SPB630TB	
			100	6	1610	107,0	14	42	63	62	38,0	25	-	-	0,9	PHP 3SPB100TB	
			106	6	1610	113,0	14	42	63	67	38,0	25	-	-	2,0	PHP 3SPB106TB	
			112	6	1610	119,0	14	42	63	72	38,0	25	-	-	2,0	PHP 3SPB112TB	
SPB	6	118	2	1610	125,0	14	42	63	78	-	25	38,0	-	2,3	PHP 3SPB118TB		
		125	2	2012	132,0	14	50	63	82	-	32	31,0	-	2,5	PHP 3SPB125TB		
		132	2	2012	139,0	14	50	63	89	-	32	31,0	-	3,1	PHP 3SPB132TB		
		140	2	2012	147,0	14	50	63	97	-	32	31,0	-	3,5	PHP 3SPB140TB		
		150	2	2517	157,0	16	60	63	107	-	45	18,0	-	4,0	PHP 3SPB150TB		

* Mass does not include bushings.
Non-functional dimensions may vary slightly.

Wedge belt pulleys
SPB taper bushed

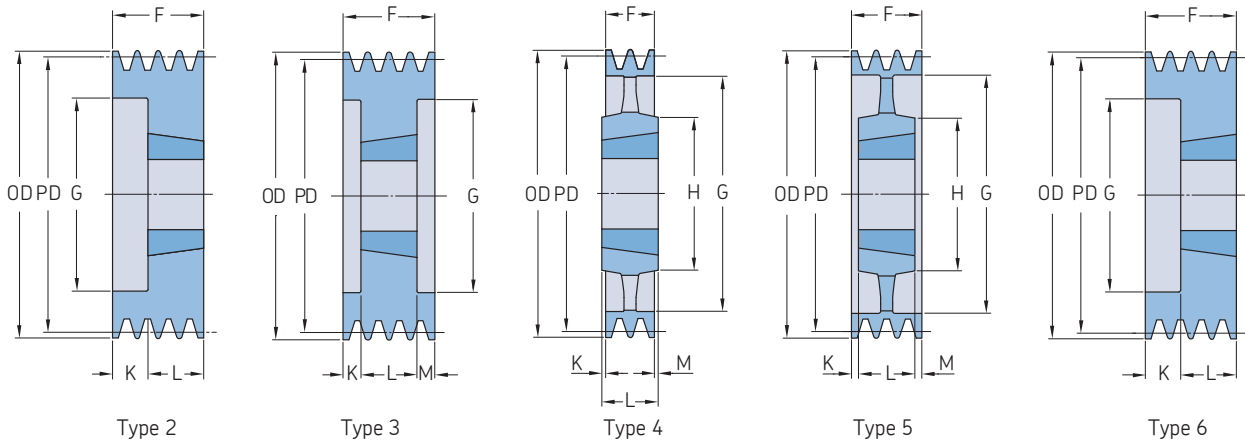

Section	Number of grooves	Pitch diameter PD	Pulley type	Bushing number	Dimensions		B Min.	Max.	F	G	K	L	M	H	Mass*	Designation
					Outer diameter OD	B										
		mm	-	-	mm											kg
SPB	3	160	2	2517	167,0	16	60	63	117	-	45	18,0	-	4,9	PHP 3SPB160TB	
		170	2	2517	177,0	16	60	63	127	-	45	18,0	-	5,7	PHP 3SPB170TB	
		180	2	2517	187,0	16	60	63	137	-	45	18,0	-	6,7	PHP 3SPB180TB	
		190	2	2517	197,0	16	60	63	147	-	45	18,0	-	7,6	PHP 3SPB190TB	
		200	2	2517	207,0	16	60	63	157	-	45	18,0	-	8,9	PHP 3SPB200TB	
	3	212	7	2517	219,0	16	60	63	169	-	45	18,0	120	8,2	PHP 3SPB212TB	
		224	4	2517	231,0	16	60	63	181	-	45	18,0	120	9,1	PHP 3SPB224TB	
		236	4	2517	243,0	16	60	63	193	-	45	18,0	120	9,8	PHP 3SPB236TB	
		250	4	3020	257,0	25	75	63	207	-	51	12,0	150	11,2	PHP 3SPB250TB	
		280	4	3020	287,0	25	75	63	237	6,0	51	6,0	150	12,0	PHP 3SPB280TB	
		300	4	3020	307,0	25	75	63	257	6,0	51	6,0	150	13,5	PHP 3SPB300TB	
		315	4	3020	322,0	25	75	63	272	6,0	51	6,0	150	14,2	PHP 3SPB315TB	
		335	4	3020	342,0	25	75	63	292	6,0	51	6,0	150	16,0	PHP 3SPB335TB	
		355	4	3020	362,0	25	75	63	312	6,0	51	6,0	150	17,7	PHP 3SPB355TB	
		400	4	3535	407,0	35	90	63	357	13,0	89	13,0	170	25,0	PHP 3SPB400TB	
		450	4	3535	457,0	35	90	63	407	-	89	26,0	170	26,3	PHP 3SPB450TB	
		500	4	3535	507,0	35	90	63	457	-	89	26,0	170	29,9	PHP 3SPB500TB	
		560	4	3535	567,0	35	90	63	517	-	89	26,0	170	37,2	PHP 3SPB560TB	
		630	4	3535	637,0	35	90	63	587	-	89	26,0	170	41,0	PHP 3SPB630TB	
		710	4	3535	717,0	35	90	63	664	13,0	89	13,0	170	48,0	PHP 3SPB710TB	
800	4	3535	807,0	35	90	63	754	13,0	89	13,0	170	55,0	PHP 3SPB800TB			
900	4	3535	907,0	35	90	63	854	13,0	89	13,0	170	64,1	PHP 3SPB900TB			
1 000	4	4040	1 007,0	40	100	63	954	20,0	102	20,0	210	72,0	PHP 3SPB1000TB			
1 250	4	4040	1 257,0	40	100	63	1 204	20,0	102	20,0	210	140,0	PHP 3SPB1250TB			
SPB	4	100	3	1210	107,0	11	32	82	58	29,0	25	29,0	-	2,4	PHP 4SPB100TB	
		106	3	1610	113,0	14	42	82	65	29,0	25	29,0	-	2,3	PHP 4SPB106TB	
		112	3	1610	119,0	14	42	82	65	29,0	25	29,0	-	2,8	PHP 4SPB112TB	
		118	3	1610	125,0	14	42	82	71	29,0	25	29,0	-	3,3	PHP 4SPB118TB	
		125	3	2012	132,0	14	50	82	82	25,0	32	25,0	-	3,0	PHP 4SPB125TB	
	3	132	3	2012	139,0	14	50	82	89	25,0	32	25,0	-	3,8	PHP 4SPB132TB	
		140	3	2517	147,0	16	60	82	97	18,5	45	18,5	-	4,0	PHP 4SPB140TB	
		150	3	2517	157,0	16	60	82	107	18,5	45	18,5	-	4,9	PHP 4SPB150TB	
		160	3	2517	167,0	16	60	82	117	18,5	45	18,5	-	5,8	PHP 4SPB160TB	
		170	3	2517	177,0	16	60	82	127	18,5	45	18,5	-	6,6	PHP 4SPB170TB	
		180	3	2517	187,0	16	60	82	137	18,5	45	18,5	-	7,7	PHP 4SPB180TB	
		190	3	2517	197,0	16	60	82	147	18,5	45	18,5	-	8,6	PHP 4SPB190TB	
		200	3	3020	207,0	25	75	82	157	15,5	51	15,5	-	9,3	PHP 4SPB200TB	
		212	3	3020	219,0	25	75	82	169	15,5	51	15,5	-	10,9	PHP 4SPB212TB	
		224	3	3020	231,0	25	75	82	181	15,5	51	15,5	-	12,4	PHP 4SPB224TB	
	3	236	3	3020	243,0	25	75	82	193	15,5	51	15,5	-	14,1	PHP 4SPB236TB	
		250	5	3020	257,0	25	75	82	207	15,5	51	15,5	150	12,7	PHP 4SPB250TB	
		280	5	3020	287,0	25	75	82	237	15,5	51	15,5	150	13,8	PHP 4SPB280TB	
		300	4	3535	307,0	35	90	82	257	-	89	7,0	150	20,5	PHP 4SPB300TB	
		315	4	3535	322,0	35	90	82	272	3,5	89	3,5	170	20,6	PHP 4SPB315TB	
	4	335	4	3535	342,0	35	90	82	292	3,5	89	3,5	170	22,0	PHP 4SPB335TB	
		355	4	3535	362,0	35	90	82	312	3,5	89	3,5	170	23,2	PHP 4SPB355TB	
		400	4	3535	407,0	35	90	82	357	3,5	89	3,5	170	26,5	PHP 4SPB400TB	
		450	4	3535	457,0	35	90	82	407	-	89	7,0	170	29,7	PHP 4SPB450TB	
		500	4	3535	507,0	35	90	82	457	-	89	7,0	170	34,7	PHP 4SPB500TB	
	4	560	4	3535	567,0	35	90	82	517	-	89	7,0	170	39,0	PHP 4SPB560TB	
		630	4	3535	637,0	35	90	82	587	-	89	7,0	170	44,5	PHP 4SPB630TB	
		710	4	3535	717,0	35	90	82	664	3,5	89	3,5	187	50,5	PHP 4SPB710TB	
		800	4	4040	807,0	40	100	82	754	10,0	102	10,0	200	60,5	PHP 4SPB800TB	
		900	4	4040	907,0	40	100	82	854	10,0	102	10,0	216	70,0	PHP 4SPB900TB	

* Mass does not include bushings.
Non-functional dimensions may vary slightly.

Wedge belt pulleys
SPB taper bushed

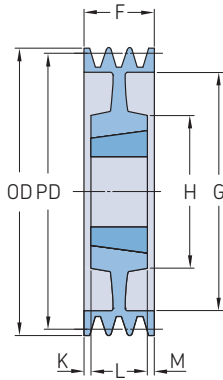

Type 7

Section	Number of grooves	Pitch diameter PD	Pulley type	Bushing number	Dimensions			F	G	K	L	M	H	Mass*	Designation
					Outer diameter OD	B Min.	Max.								
					mm								kg		
SPB	4	1 000	4	4040	1 007,0	40	100	82	954	10,0	102	10,0	216	76,5	PHP 4SPB1000TB
		1 250	4	4545	1 257,0	55	110	82	1 204	16,0	114	16,0	225	162,0	PHP 4SPB1250TB
SPB	5	125	6	2012	132,0	14	50	101	87	69,0	32	-	-	3,6	PHP 5SPB125TB
		132	6	2517	139,0	16	60	101	94	56,0	45	-	-	3,8	PHP 5SPB132TB
		140	3	2517	147,0	16	60	101	97	28,0	45	28,0	-	4,2	PHP 5SPB140TB
		150	3	2517	157,0	16	60	101	107	28,0	45	28,0	-	5,7	PHP 5SPB150TB
		160	3	2517	167,0	16	60	101	117	28,0	45	28,0	-	6,7	PHP 5SPB160TB
		170	3	3020	177,0	25	75	101	127	25,0	51	25,0	-	6,7	PHP 5SPB170TB
		180	3	3020	187,0	25	75	101	137	25,0	51	25,0	-	7,8	PHP 5SPB180TB
		190	3	3020	197,0	25	75	101	147	25,0	51	25,0	-	9,1	PHP 5SPB190TB
		200	3	3020	207,0	25	75	101	157	25,0	51	25,0	-	10,3	PHP 5SPB200TB
		212	3	3020	219,0	25	75	101	169	25,0	51	25,0	-	12,2	PHP 5SPB212TB
		224	3	3020	231,0	25	75	101	181	25,0	51	25,0	-	13,7	PHP 5SPB224TB
		236	3	3535	243,0	35	90	101	193	6,0	89	6,0	-	15,9	PHP 5SPB236TB
		250	3	3535	257,0	35	90	101	207	6,0	89	6,0	-	18,6	PHP 5SPB250TB
		280	7	3535	287,0	35	90	101	237	6,0	89	6,0	170	21,4	PHP 5SPB280TB
		300	5	3535	307,0	35	90	101	257	6,0	89	6,0	170	22,5	PHP 5SPB300TB
		315	5	3535	322,0	35	90	101	272	6,0	89	6,0	170	22,3	PHP 5SPB315TB
		335	5	3535	342,0	35	90	101	292	6,0	89	6,0	170	24,0	PHP 5SPB335TB
		355	4	3535	362,0	35	90	101	312	6,0	89	6,0	170	25,5	PHP 5SPB355TB
		400	5	3535	407,0	35	90	101	357	6,0	89	6,0	170	30,2	PHP 5SPB400TB
		450	5	3535	457,0	35	90	101	407	-	89	12,0	170	32,8	PHP 5SPB450TB
		500	5	3535	507,0	35	90	101	457	-	89	12,0	170	36,7	PHP 5SPB500TB
		530	5	3525	537,0	35	90	101	487	-	89	12,0	170	39,2	PHP 5SPB530TB
		560	4	4040	567,0	40	100	101	517	-	102	1,0	200	45,6	PHP 5SPB560TB
		630	4	4040	637,0	40	100	101	587	-	102	1,0	200	50,0	PHP 5SPB630TB
		710	4	4040	717,0	40	100	101	664	-	102	1,0	200	63,5	PHP 5SPB710TB
		800	4	4040	807,0	40	100	101	754	-	102	1,0	200	67,0	PHP 5SPB800TB
900	4	4040	907,0	40	100	101	854	-	114	1,0	200	103,0	PHP 5SPB900TB		
1 000	4	4545	1 007,0	55	110	101	954	6,5	114	6,5	225	110,0	PHP 5SPB1000TB		
1 250	4	4545	1 257,0	55	110	101	1 204	6,5	114	6,5	225	180,0	PHP 5SPB1250TB		
SPB	6	125	3	2012	132,0	14	50	120	83	44,0	32	44,0	-	4,2	PHP 6SPB125TB
		132	3	2012	139,0	14	50	120	90	44,0	32	44,0	-	4,5	PHP 6SPB132TB
		140	3	2517	147,0	16	60	120	97	37,5	45	37,5	-	4,7	PHP 6SPB140TB
		150	3	2517	157,0	16	60	120	107	37,5	45	37,5	-	6,5	PHP 6SPB150TB
		160	3	3020	167,0	25	75	120	117	34,5	51	34,5	-	5,9	PHP 6SPB160TB
		170	3	3020	177,0	25	75	120	127	34,5	51	34,5	-	7,6	PHP 6SPB170TB
		180	3	3020	187,0	25	75	120	137	34,5	51	34,5	-	8,9	PHP 6SPB180TB
		190	3	3020	197,0	25	75	120	147	34,5	51	34,5	-	10,2	PHP 6SPB190TB
		200	3	3020	207,0	25	75	120	157	34,5	51	34,5	-	11,7	PHP 6SPB200TB
		212	3	3535	219,0	35	90	120	169	15,5	89	15,5	-	13,2	PHP 6SPB212TB
		224	3	3535	231,0	35	90	120	181	15,5	89	15,5	-	15,2	PHP 6SPB224TB
		236	3	3535	243,0	35	90	120	193	15,5	89	15,5	-	17,6	PHP 6SPB236TB
		250	3	3535	257,0	35	90	120	207	15,5	89	15,5	-	20,2	PHP 6SPB250TB
		280	7	3535	287,0	35	90	120	237	15,5	89	15,5	191	23,5	PHP 6SPB280TB
		300	5	3535	307,0	35	90	120	257	15,5	89	15,5	191	24,0	PHP 6SPB300TB
		315	5	3535	322,0	35	90	120	272	15,5	89	15,5	191	24,1	PHP 6SPB315TB
		335	5	3535	342,0	35	90	120	292	15,5	89	15,5	191	26,0	PHP 6SPB335TB
		355	5	3535	362,0	35	90	120	312	15,5	89	15,5	191	28,3	PHP 6SPB355TB
		400	5	3535	407,0	35	90	120	357	15,5	89	15,5	191	31,8	PHP 6SPB400TB
		450	5	4040	457,0	40	100	120	407	-	102	18,0	191	35,3	PHP 6SPB450TB
		500	5	4040	507,0	40	100	120	457	-	102	18,0	191	40,7	PHP 6SPB500TB
		560	5	4040	567,0	40	100	120	517	-	102	18,0	191	49,2	PHP 6SPB560TB

* Mass does not include bushings.
Non-functional dimensions may vary slightly.

Wedge belt pulleys

SPB taper bushed | SPC taper bushed

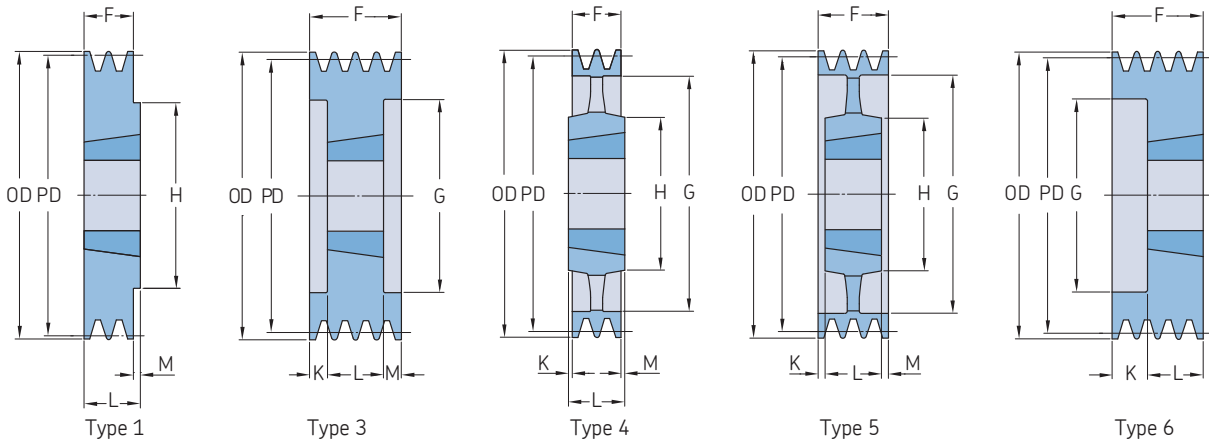

Section	Number of grooves	Pitch diameter PD	Pulley type	Bushing number	Dimensions		B Min.	Max.	F	G	K	L	M	H	Mass*	Designation
					Outer diameter OD	mm										
-																
SPB	6	630	5	4040	637,0	40	100	120	587	-	102	18,0	191	53,5	PHP 6SPB630TB	
		710	5	4040	717,0	40	100	120	664	9,0	102	9,0	240	69,0	PHP 6SPB710TB	
		800	5	4545	807,0	55	110	120	754	3,0	114	3,0	240	84,5	PHP 6SPB800TB	
		900	5	4545	907,0	55	110	120	854	3,0	114	3,0	240	94,5	PHP 6SPB900TB	
		1 000	5	4545	1 007,0	55	110	120	954	3,0	114	3,0	240	104,0	PHP 6SPB1000TB	
		1 250	5	4545	1 257,0	55	110	120	1 204	3,0	127	3,0	240	210,0	PHP 6SPB1250TB	
	SPB	8	140	3	2517	147,0	16	60	158	97	56,5	45	56,5	-	6,8	PHP 8SPB140TB
			160	3	3020	167,0	25	75	158	117	53,5	51	53,5	-	8,3	PHP 8SPB160TB
			170	3	3030	177,0	35	75	158	127	41,0	76	41,0	-	9,5	PHP 8SPB170TB
			180	3	3030	187,0	35	75	158	137	41,0	76	41,0	-	10,8	PHP 8SPB180TB
190			3	3030	197,0	35	75	158	147	41,0	76	41,0	-	12,3	PHP 8SPB190TB	
200			3	3535	207,0	35	90	158	157	34,5	89	34,5	-	13,7	PHP 8SPB200TB	
212			3	3535	219,0	35	90	158	169	34,5	89	34,5	-	15,8	PHP 8SPB212TB	
224			3	3535	231,0	35	90	158	181	34,5	89	34,5	-	17,9	PHP 8SPB224TB	
236			3	3535	243,0	35	90	158	193	34,5	89	34,5	-	20,0	PHP 8SPB236TB	
250			3	3535	257,0	35	90	158	207	34,5	89	34,5	-	23,2	PHP 8SPB250TB	
		280	7	3535	287,0	35	90	158	237	34,5	89	34,5	-	26,6	PHP 8SPB280TB	
		300	7	3535	307,0	35	90	158	257	34,5	89	34,5	170	27,3	PHP 8SPB300TB	
		315	7	3535	322,0	35	90	158	272	34,5	89	34,5	170	28,0	PHP 8SPB315TB	
		335	7	3535	342,0	35	90	158	292	34,5	89	34,5	170	30,5	PHP 8SPB335TB	
		355	7	3535	362,0	35	90	158	312	34,5	89	34,5	170	31,5	PHP 8SPB355TB	
		400	5	4040	407,0	40	100	158	357	28,0	102	28,0	200	43,0	PHP 8SPB400TB	
		450	5	4040	457,0	40	100	158	407	28,0	102	28,0	200	46,0	PHP 8SPB450TB	
		500	5	4040	507,0	40	100	158	457	28,0	102	28,0	200	52,0	PHP 8SPB500TB	
		560	5	4545	567,0	55	110	158	517	22,0	114	22,0	225	54,5	PHP 8SPB560TB	
		630	5	4545	637,0	55	110	158	587	22,0	114	22,0	225	67,0	PHP 8SPB630TB	
	710	5	4545	717,0	55	110	158	664	22,0	114	22,0	225	75,5	PHP 8SPB710TB		
	800	5	4545	807,0	55	110	158	754	22,0	114	22,0	225	94,5	PHP 8SPB800TB		
	900	5	4545	907,0	55	110	158	854	22,0	114	22,0	225	113,5	PHP 8SPB900TB		
	1 000	5	5050	1 007,0	70	125	158	954	15,5	127	15,5	245	121,5	PHP 8SPB1000TB		
	1 250	5	5050	1 257,0	70	125	158	1 204	15,5	127	15,5	245	242,0	PHP 8SPB1250TB		
SPB	10	224	3	3535	231,0	35	90	196	181	53,5	89	53,5	-	20,5	PHP 10SPB224TB	
		236	3	3535	243,0	35	90	196	193	53,5	89	53,5	-	22,6	PHP 10SPB236TB	
		250	3	3535	257,0	35	90	196	207	53,5	89	53,5	-	26,6	PHP 10SPB250TB	
		280	6	3535	287,0	35	90	196	237	53,5	89	53,5	-	27,8	PHP 10SPB280TB	
		315	7	3535	322,0	35	90	196	272	53,5	89	53,5	170	28,8	PHP 10SPB315TB	
		335	5	4040	342,0	40	100	196	292	47,0	102	47,0	200	32,0	PHP 10SPB335TB	
		355	5	4040	362,0	40	100	196	312	47,0	102	47,0	200	33,5	PHP 10SPB355TB	
		400	5	4040	407,0	40	100	196	357	47,0	102	47,0	200	36,0	PHP 10SPB400TB	
		450	5	4545	457,0	55	110	196	407	41,0	114	41,0	225	47,0	PHP 10SPB450TB	
		500	5	4545	507,0	55	110	196	457	41,0	114	41,0	225	55,0	PHP 10SPB500TB	
	560	5	4545	567,0	55	110	196	517	41,0	114	41,0	225	59,0	PHP 10SPB560TB		
	630	5	4545	637,0	55	110	196	587	41,0	114	41,0	225	66,0	PHP 10SPB630TB		
	710	5	4545	717,0	55	125	196	664	41,0	114	41,0	225	75,0	PHP 10SPB710TB		
	800	5	4545	807,0	55	125	196	754	41,0	114	41,0	225	96,0	PHP 10SPB800TB		
	900	5	5050	907,0	70	125	196	854	34,5	127	34,5	245	119,0	PHP 10SPB900TB		
		1 000	5	5050	1 007,0	70	125	196	954	34,5	127	34,5	245	141,0	PHP 10SPB1000TB	
		1 250	5	5050	1 257,0	70	125	196	1 203	35,0	127	-	-	265,0	PHP 10SPB1250TB	
	SPC	3	200	3	2517	209,6	16	60	85	150	20,0	45	20,0	-	10,2	PHP 3SPC200TB
212			3	3020	221,6	25	75	85	162	17,0	51	17,0	-	11,2	PHP 3SPC212TB	
224			3	3020	233,6	25	75	85	173	17,0	51	17,0	-	12,7	PHP 3SPC224TB	
236			3	3020	245,6	25	75	85	185	17,0	51	17,0	-	14,4	PHP 3SPC236TB	
250			3	3020	259,6	25	75	85	194	17,0	51	17,0	-	16,5	PHP 3SPC250TB	

* Mass does not include bushings.
Non-functional dimensions may vary slightly.

Wedge belt pulleys
SPC taper bushed

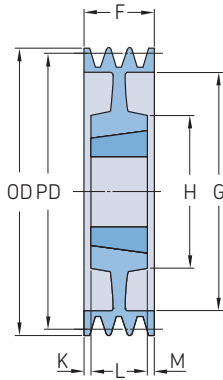

Type 7

Section	Number of grooves	Pitch diameter PD	Pulley type	Bushing number	Dimensions									Mass*	Designation		
					Outer diameter OD	B Min. Max.	F	G	K	L	M	H					
					mm									kg			
SPC	3	265	1	3535	274,6	35	90	85	—	—	89	4,0	170	19,7	PHP 3SPC265TB		
		280	1	3535	289,6	35	90	85	—	—	89	4,0	170	22,7	PHP 3SPC280TB		
		300	4	3535	309,6	35	90	85	249	2,0	89	2,0	170	22,7	PHP 3SPC300TB		
		315	7	3535	324,6	35	90	85	264	2,0	89	2,0	170	22,0	PHP 3SPC315TB		
		335	4	3535	344,6	35	90	85	284	2,0	89	2,0	170	24,1	PHP 3SPC335TB		
		355	4	3535	364,6	35	90	85	304	2,0	89	2,0	170	26,2	PHP 3SPC355TB		
	SPC	4	375	4	3535	384,6	35	90	85	324	2,0	89	2,0	170	28,0	PHP 3SPC375TB	
			400	4	3535	409,6	35	90	85	344	2,0	89	2,0	170	29,3	PHP 3SPC400TB	
			425	4	3535	434,6	35	90	85	369	2,0	89	2,0	170	32,8	PHP 3SPC425TB	
			450	4	3535	459,6	35	90	85	394	2,0	89	2,0	170	34,7	PHP 3SPC450TB	
			475	4	3535	484,6	35	90	85	419	2,0	89	2,0	170	36,5	PHP 3SPC475TB	
			500	4	3535	509,6	35	90	85	444	2,0	89	2,0	170	40,0	PHP 3SPC500TB	
		SPC	4	530	4	3535	539,6	35	90	85	474	2,0	89	2,0	170	42,5	PHP 3SPC530TB
				560	4	3535	569,6	35	90	85	504	2,0	89	2,0	170	45,9	PHP 3SPC560TB
				630	4	4040	639,6	40	100	85	574	8,5	102	8,5	200	76,3	PHP 3SPC630TB
				710	4	4040	719,6	70	100	85	654	8,5	102	8,5	200	81,6	PHP 3SPC710TB
				800	4	4545	809,6	55	110	85	737	14,5	114	14,5	225	87,0	PHP 3SPC800TB
				1 000	4	5050	1 009,6	70	125	85	937	21,0	127	21,0	245	120,0	PHP 3SPC1000TB
SPC	5	1 250	4	5050	1 259,6	70	125	85	1 187	21,0	127	21,0	245	175,0	PHP 3SPC1250TB		
		200	3	3020	209,6	25	75	111	144	30,0	51	30,0	—	11,3	PHP 4SPC200TB		
		212	3	3020	221,6	25	75	111	156	30,0	51	30,0	—	13,0	PHP 4SPC212TB		
		224	3	3535	233,6	35	90	111	168	11,0	89	11,0	—	14,5	PHP 4SPC224TB		
		236	3	3535	245,6	35	90	111	180	11,0	89	11,0	—	16,7	PHP 4SPC236TB		
		250	3	3535	259,6	35	90	111	194	11,0	89	11,0	—	19,3	PHP 4SPC250TB		
	SPC	5	265	3	3535	274,6	35	90	111	209	11,0	89	11,0	—	22,4	PHP 4SPC265TB	
			280	7	3535	289,6	35	90	111	224	11,0	89	11,0	—	25,4	PHP 4SPC280TB	
			300	5	3535	309,6	35	90	111	244	11,0	89	11,0	170	25,4	PHP 4SPC300TB	
			315	5	3535	324,6	35	90	111	259	11,0	89	11,0	170	25,3	PHP 4SPC315TB	
			335	5	3535	344,6	35	90	111	279	11,0	89	11,0	170	27,4	PHP 4SPC335TB	
			355	5	3535	364,6	35	90	111	299	11,0	89	11,0	170	29,6	PHP 4SPC355TB	
	SPC	5	375	5	3535	384,6	35	90	111	319	11,0	89	11,0	170	31,3	PHP 4SPC375TB	
			400	5	3535	409,6	35	90	111	344	11,0	89	11,0	170	33,8	PHP 4SPC400TB	
			425	5	3535	434,6	35	90	111	369	11,0	89	11,0	170	38,0	PHP 4SPC425TB	
			450	5	3535	459,6	35	90	111	394	11,0	89	11,0	170	41,3	PHP 4SPC450TB	
			475	5	3535	484,6	35	90	111	419	11,0	89	11,0	170	43,7	PHP 4SPC475TB	
			500	5	3535	509,6	35	90	111	444	11,0	89	11,0	170	46,0	PHP 4SPC500TB	
SPC	5	530	5	4040	539,6	40	100	111	474	4,5	102	4,5	170	52,0	PHP 4SPC530TB		
		560	5	4040	569,6	40	100	111	504	4,5	102	4,5	200	58,0	PHP 4SPC560TB		
		630	4	4545	639,6	55	110	111	574	1,5	114	1,5	225	63,8	PHP 4SPC630TB		
		710	4	5050	719,6	70	125	111	654	8,0	127	8,0	267	83,2	PHP 4SPC710TB		
		800	4	5050	809,6	70	125	111	737	8,0	127	8,0	267	102,5	PHP 4SPC800TB		
		1 000	4	5050	1 009,6	70	125	111	937	8,0	127	8,0	267	130,0	PHP 4SPC1000TB		
SPC	5	1 250	4	5050	1 259,6	70	125	111	1 187	8,0	127	8,0	267	186,0	PHP 4SPC1250TB		
		200	3	3535	209,6	35	90	136	150	23,5	89	23,5	—	12,2	PHP 5SPC200TB		
		212	3	3535	221,6	35	90	136	160	23,5	89	23,5	—	14,5	PHP 5SPC212TB		
		224	3	3535	233,6	35	90	136	173	23,5	89	23,5	—	16,6	PHP 5SPC224TB		
		236	3	3535	245,6	35	90	136	185	23,5	89	23,5	—	18,9	PHP 5SPC236TB		
		250	3	3535	259,6	35	90	136	198	23,5	89	23,5	—	21,5	PHP 5SPC250TB		
	SPC	5	265	3	3535	274,6	35	90	136	213	23,5	89	23,5	—	25,0	PHP 5SPC265TB	
			280	3	3535	289,6	35	90	136	228	23,5	89	23,5	—	28,4	PHP 5SPC280TB	
			300	7	3535	309,6	35	90	136	247	23,5	89	23,5	170	28,2	PHP 5SPC300TB	
			315	5	3535	324,6	35	90	136	264	23,5	89	23,5	170	28,1	PHP 5SPC315TB	
			335	5	3535	344,6	35	90	136	280	23,5	89	23,5	170	31,1	PHP 5SPC335TB	

* Mass does not include bushings.
Non-functional dimensions may vary slightly.

Wedge belt pulleys
SPC taper bushed

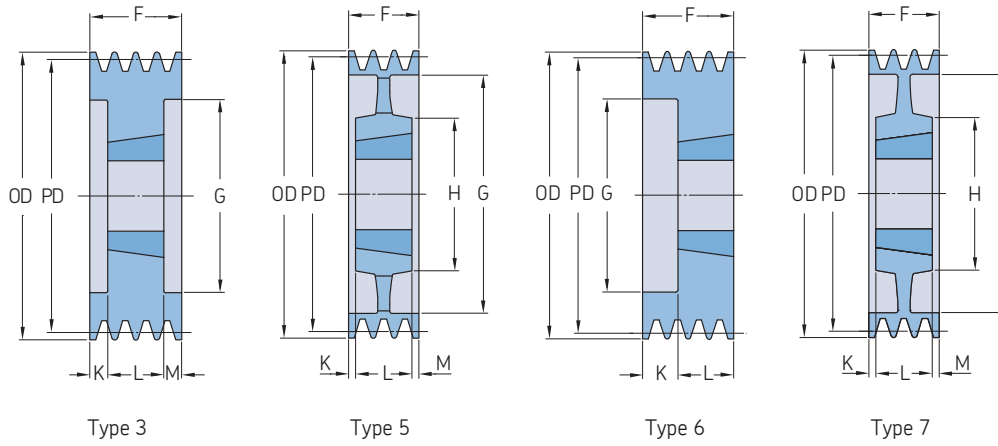

Section	Number of grooves	Pitch diameter PD	Pulley type	Bushing number	Dimensions			F	G	K	L	M	H	Mass*	Designation		
					Outer diameter OD	B Min.	Max.										
		mm	-	-	mm										kg	-	
SPC	5	355	5	3535	364,6	35	90	136	304	23,5	89	23,5	170	33,1	PHP 5SPC355TB		
		375	5	3535	384,6	35	90	136	324	23,5	89	23,5	170	35,6	PHP 5SPC375TB		
		400	5	3535	409,6	35	90	136	344	23,5	89	23,5	170	38,5	PHP 5SPC400TB		
		425	5	3535	434,6	35	90	136	369	23,5	89	23,5	170	42,5	PHP 5SPC425TB		
		450	5	4040	459,6	40	100	136	394	17,0	102	17,0	200	44,3	PHP 5SPC450TB		
		475	5	4040	484,6	40	100	136	419	17,0	102	17,0	200	48,5	PHP 5SPC475TB		
	5	500	5	4040	509,6	40	100	136	444	17,0	102	17,0	200	51,0	PHP 5SPC500TB		
		530	5	4545	539,6	55	110	136	474	11,0	102	11,0	200	66,0	PHP 5SPC530TB		
		560	5	4545	569,6	55	110	136	504	11,0	114	11,0	200	66,7	PHP 5SPC560TB		
		630	5	5050	639,6	70	125	136	574	4,5	127	4,5	245	73,0	PHP 5SPC630TB		
		710	5	5050	719,6	70	125	136	654	4,5	127	4,5	245	93,0	PHP 5SPC710TB		
		800	5	5050	809,6	70	125	136	737	4,5	127	4,5	245	119,0	PHP 5SPC800TB		
		1 000	5	5050	1 009,6	70	125	136	937	4,5	127	4,5	245	147,0	PHP 5SPC1000TB		
		1 250	5	5050	1 259,6	70	125	136	1 187	4,5	127	4,5	245	210,0	PHP 5SPC1250TB		
		SPC	6	200	3	3535	209,6	35	90	162	148	36,5	89	36,5	-	14,1	PHP 6SPC200TB
				212	3	3535	221,6	35	90	162	160	36,5	89	36,5	-	16,5	PHP 6SPC212TB
				224	3	3535	233,6	35	90	162	173	36,5	89	36,5	-	18,0	PHP 6SPC224TB
				236	3	3535	245,6	35	90	162	185	36,5	89	36,5	-	21,3	PHP 6SPC236TB
250	3			3535	259,6	35	90	162	198	36,5	89	36,5	-	29,0	PHP 6SPC250TB		
265	3			3535	274,6	35	90	162	213	36,5	89	36,5	-	30,3	PHP 6SPC265TB		
7	280		7	3535	289,6	35	90	162	228	36,5	89	36,5	-	31,5	PHP 6SPC280TB		
	300		7	3535	309,6	35	90	162	247	36,5	89	36,5	170	31,5	PHP 6SPC300TB		
	315		5	3535	324,6	35	90	162	264	36,5	89	36,5	170	33,2	PHP 6SPC315TB		
	335		5	3535	344,6	35	90	162	280	36,5	89	36,5	170	37,5	PHP 6SPC335TB		
	355		5	3535	364,6	35	90	162	304	36,5	89	36,5	170	40,5	PHP 6SPC355TB		
	375		5	4040	384,6	40	100	162	324	30,0	102	30,0	200	44,5	PHP 6SPC375TB		
5	400		5	4040	409,6	40	100	162	348	30,0	102	30,0	200	48,0	PHP 6SPC400TB		
	425		5	4040	434,6	40	100	162	369	30,0	102	30,0	225	51,0	PHP 6SPC425TB		
	450		7	4545	459,6	55	110	162	394	24,0	114	24,0	225	57,5	PHP 6SPC450TB		
	475		5	4545	484,6	55	110	162	419	24,0	114	24,0	225	62,0	PHP 6SPC475TB		
	500		5	4545	509,6	55	110	162	444	24,0	114	24,0	225	67,0	PHP 6SPC500TB		
	530		5	5050	539,6	70	125	162	474	17,5	114	17,5	245	74,5	PHP 6SPC530TB		
	560	5	5050	569,6	70	125	162	504	17,5	127	17,5	245	77,5	PHP 6SPC560TB			
	630	5	5050	639,6	70	125	162	574	17,5	127	17,5	245	88,5	PHP 6SPC630TB			
	710	5	5050	719,6	70	125	162	654	17,5	127	17,5	245	107,3	PHP 6SPC710TB			
	800	5	5050	809,6	70	125	162	737	17,5	127	17,5	245	126,0	PHP 6SPC800TB			
	1 000	5	5050	1 009,6	70	125	162	937	17,5	127	17,5	245	185,0	PHP 6SPC1000TB			
	1 250	5	5050	1 259,6	70	125	162	1 187	17,5	127	17,5	245	258,0	PHP 6SPC1250TB			
SPC	8	200	3	3535	209,6	35	90	213	148	62,0	89	62,0	-	20,0	PHP 8SPC200TB		
		212	3	3535	221,6	35	90	213	160	62,0	89	62,0	-	21,3	PHP 8SPC212TB		
		224	3	3535	233,6	35	90	213	170	62,0	89	62,0	-	22,9	PHP 8SPC224TB		
		236	3	3535	245,6	35	90	213	184	62,0	89	62,0	-	25,9	PHP 8SPC236TB		
		250	3	3535	259,6	35	90	213	198	62,0	89	62,0	-	29,0	PHP 8SPC250TB		
		265	3	3535	274,6	35	90	213	213	62,0	89	62,0	-	32,5	PHP 8SPC265TB		
	3	280	3	3535	289,6	35	90	213	228	62,0	89	62,0	-	36,1	PHP 8SPC280TB		
		300	3	4040	309,6	40	100	213	207	55,5	102	55,5	-	37,1	PHP 8SPC300TB		
		315	3	4040	324,6	40	100	213	258	55,5	102	55,5	-	40,0	PHP 8SPC315TB		
		335	7	4040	344,6	40	100	213	280	55,5	102	55,5	210	44,0	PHP 8SPC335TB		
		355	5	4040	364,6	40	100	213	304	55,5	102	55,5	210	49,0	PHP 8SPC355TB		
		375	5	4545	384,6	55	110	213	324	49,5	114	49,5	242	54,5	PHP 8SPC375TB		
	5	400	5	4545	409,6	55	110	213	348	49,5	114	49,5	242	58,0	PHP 8SPC400TB		
		425	5	4545	434,6	55	110	213	369	49,5	114	49,5	242	63,5	PHP 8SPC425TB		
		450	5	5050	459,6	70	125	213	394	43,0	127	43,0	267	70,0	PHP 8SPC450TB		

* Mass does not include bushings.
Non-functional dimensions may vary slightly.

Wedge belt pulleys
SPC taper bushed

Section	Number of grooves	Pitch diameter PD	Pulley type	Bushing number	Dimensions									Mass*	Designation
					Outer diameter OD	B Min.	Max.	F	G	K	L	M	H		
–	–	mm	–	–	mm									kg	–
SPC	8	475	5	5050	484,6	70	125	213	419	43,0	127	43,0	267	72,0	PHP 8SPC475TB
		500	5	5050	509,6	70	125	213	444	43,0	127	43,0	267	82,5	PHP 8SPC500TB
		530	5	5050	539,6	70	125	213	474	43,0	127	43,0	267	82,5	PHP 8SPC530TB
		560	5	5050	569,6	70	125	213	504	43,0	127	43,0	267	94,5	PHP 8SPC560TB
		630	5	5050	639,6	70	125	213	574	43,0	127	43,0	267	102,0	PHP 8SPC630TB
		710	5	5050	719,6	70	125	213	656	43,0	127	43,0	267	123,5	PHP 8SPC710TB
		800	5	5050	809,6	70	125	213	737	43,0	127	43,0	267	145,0	PHP 8SPC800TB
		1 000	5	5050	1 009,6	70	125	213	937	43,0	127	43,0	267	207,0	PHP 8SPC1000TB
		1 250	5	5050	1 259,6	70	125	213	1 187	43,0	127	43,0	267	285,0	PHP 8SPC1250TB
		SPC	10	224	3	4040	233,6	40	100	264	168	81,0	102	–	–
236	3			4040	245,6	40	100	264	180	81,0	102	81,0	–	30,9	PHP 10SPC236TB
250	3			4040	259,6	40	100	264	196	81,0	102	81,0	–	35,0	PHP 10SPC250TB
265	3			4040	274,6	40	100	264	209	81,0	102	81,0	–	39,5	PHP 10SPC265TB
280	3			4040	289,6	40	100	264	226	81,0	102	81,0	–	42,1	PHP 10SPC280TB
300	3			4545	309,6	55	110	264	245	75,0	114	75,0	–	44,1	PHP 10SPC300TB
315	3			4545	324,6	55	110	264	258	75,0	114	75,0	–	47,0	PHP 10SPC315TB
335	3			4545	344,6	55	110	264	279	75,0	114	75,0	–	51,0	PHP 10SPC335TB
355	3			4545	364,6	55	110	264	299	75,0	114	75,0	–	57,0	PHP 10SPC355TB
375	3			4545	384,6	55	110	264	319	68,5	127	68,5	245	62,5	PHP 10SPC375TB
400	6			5050	409,6	70	125	264	342	68,5	127	68,5	245	66,0	PHP 10SPC400TB
425	7			5050	434,6	70	125	264	369	68,5	127	68,5	245	70,5	PHP 10SPC425TB
450	5			5050	459,6	70	125	264	394	68,5	127	68,5	245	78,0	PHP 10SPC450TB
475	5			5050	484,6	70	125	264	419	68,5	127	68,5	245	82,0	PHP 10SPC475TB
500	5			5050	509,6	70	125	264	444	68,5	127	68,5	245	95,5	PHP 10SPC500TB
530	5			5050	539,6	70	125	264	474	68,5	127	68,5	245	106,0	PHP 10SPC530TB
560	5			5050	569,6	70	125	264	504	68,5	127	68,5	245	94,7	PHP 10SPC560TB
630	5			5050	639,6	70	125	264	574	68,5	127	68,5	245	113,2	PHP 10SPC630TB
710	5			5050	719,6	70	125	264	654	68,5	127	68,5	245	133,5	PHP 10SPC710TB
800	5			5050	809,6	70	125	264	737	68,5	127	68,5	245	160,5	PHP 10SPC800TB
1 000	5			5050	1 009,6	70	125	264	937	68,5	127	68,5	245	227,5	PHP 10SPC1000TB
1 250	5			5050	1 259,6	70	125	264	1 187	68,5	127	68,5	245	300,0	PHP 10SPC1250TB

* Mass does not include bushings.
Non-functional dimensions may vary slightly.

Classical V-belt pulleys

A/B taper bushed

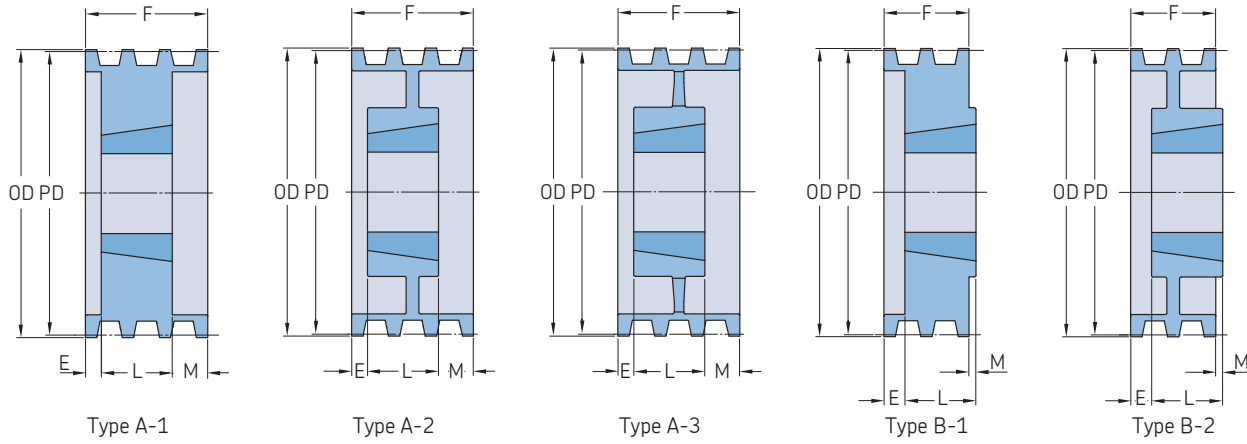

Section	Number of grooves	Pitch diameter Belt A		Belt B		Pulley type	Bushing number	Dimensions			F	E	L	M	Mass ²⁾	Designation		
		PD	PD	PD	PD			Outer diameter OD	B Min.	Max.								
		mm	in.	mm	in.			mm										
A/B	1	76,2	3,0	86,4	3,4	A-1	1210	95,3	15,88	31,75	25,40	-	25,40	-	1,0	PHP 1-B34TB		
		81,3	3,2	91,4	3,6	A-1	1210	100,3	15,88	31,75	25,40	-	25,40	-	1,2	PHP 1-B36TB		
		86,4	3,4	96,5	3,8	A-1	1610	105,4	12,70	41,28	25,40	-	25,40	-	1,3	PHP 1-B38TB		
		91,4	3,6	101,6	4,0	A-1	1610	110,5	12,70	41,28	25,40	-	25,40	-	1,4	PHP 1-B40TB		
		96,5	3,8	106,7	4,2	A-1	1610	115,6	12,70	41,28	25,40	-	25,40	-	1,6	PHP 1-B42TB		
		101,6	4,0	111,8	4,4	A-1	1610	120,7	12,70	41,28	25,40	-	25,40	-	1,7	PHP 1-B44TB		
		106,7	4,2	116,8	4,6	A-1	1610	125,7	12,70	41,28	25,40	-	25,40	-	1,8	PHP 1-B46TB		
		111,8	4,4	121,9	4,8	A-1	1610	130,8	12,70	41,28	25,40	-	25,40	-	2,0	PHP 1-B48TB		
		116,8	4,6	127,0	5,0	A-1	1610	135,9	12,70	41,28	25,40	-	25,40	-	2,2	PHP 1-B50TB		
		121,9	4,8	132,1	5,2	A-1	1610	141,0	12,70	41,28	25,40	-	25,40	-	2,3	PHP 1-B52TB		
		127,0	5,0	137,2	5,4	A-1	1610	146,1	12,70	41,28	25,40	-	25,40	-	2,5	PHP 1-B54TB		
		132,1	5,2	142,2	5,6	A-1	1610	151,1	12,70	41,28	25,40	-	25,40	-	2,7	PHP 1-B56TB		
		137,2	5,4	147,3	5,8	A-1	1610	156,2	12,70	41,28	25,40	-	25,40	-	2,9	PHP 1-B58TB		
		142,2	5,6	152,4	6,0	A-1	1610	161,3	12,70	41,28	25,40	-	25,40	-	3,0	PHP 1-B60TB		
		147,3	5,8	157,5	6,2	A-1	1610	166,4	12,70	41,28	25,40	-	25,40	-	3,2	PHP 1-B62TB		
		152,4	6,0	162,6	6,4	A-1	1610	171,5	12,70	41,28	25,40	-	25,40	-	3,6	PHP 1-B64TB		
		157,5	6,2	167,6	6,6	A-1	1610	176,5	12,70	41,28	25,40	-	25,40	-	3,9	PHP 1-B66TB		
		162,6	6,4	172,7	6,8	A-1	1610	181,6	12,70	41,28	25,40	-	25,40	-	4,1	PHP 1-B68TB		
		177,8	7,0	188,0	7,4	B-1	2517 ³⁾	196,9	19,05	63,50	25,40	-	44,45	19,05	4,3	PHP 1-B74TB		
		208,3	8,2	218,4	8,6	B-2	2517 ³⁾	227,3	19,05	63,50	25,40	-	44,45	19,05	5,4	PHP 1-B86TB		
		228,6	9,0	238,8	9,4	B-2	2517 ³⁾	247,7	19,05	63,50	25,40	-	44,45	19,05	6,4	PHP 1-B94TB		
		269,2	10,6	279,4	11,0	B-2	2517 ³⁾	288,3	19,05	63,50	25,40	-	44,45	19,05	8,2	PHP 1-B110TB		
		304,8	12,0	315,0	12,4	C-3	2517 ³⁾	323,9	19,05	63,50	25,40	6,35	44,45	12,70	8,4	PHP 1-B124TB		
		381,0	15,0	391,2	15,4	C-3	2517 ³⁾	400,1	19,05	63,50	25,40	6,35	44,45	12,70	8,6	PHP 1-B154TB		
		457,2	18,0	467,4	18,4	C-3	2517 ³⁾	476,3	19,05	63,50	28,58	4,76	44,45	11,11	10,9	PHP 1-B184TB		
		A/B	2	76,2	3,0	86,4	3,4	A-1	1210	95,3	15,88	31,75	44,45	19,05	25,40	-	1,0	PHP 2-B34TB
				81,3	3,2	91,4	3,6	A-1	1210	100,3	15,88	31,75	44,45	19,05	25,40	-	1,2	PHP 2-B36TB
				86,4	3,4	96,5	3,8	A-1	1610	105,4	12,70	41,28	44,45	19,05	25,40	-	1,3	PHP 2-B38TB
				91,4	3,6	101,6	4,0	A-1	1610	110,5	12,70	41,28	44,45	19,05	25,40	-	1,4	PHP 2-B40TB
				96,5	3,8	106,7	4,2	A-1	1610	115,6	12,70	41,28	44,45	19,05	25,40	-	1,8	PHP 2-B42TB
101,6	4,0			111,8	4,4	A-1	1610	120,7	12,70	41,28	44,45	19,05	25,40	-	2,0	PHP 2-B44TB		
106,7	4,2			116,8	4,6	A-1	1610	125,7	12,70	41,28	44,45	19,05	25,40	-	2,3	PHP 2-B46TB		
111,8	4,4			121,9	4,8	A-1	1610	130,8	12,70	41,28	44,45	19,05	25,40	-	2,5	PHP 2-B48TB		
116,8	4,6			127,0	5,0	A-1	1610	135,9	12,70	41,28	44,45	19,05	25,40	-	2,7	PHP 2-B50TB		
121,9	4,8			132,1	5,2	A-1	1610	141,0	12,70	41,28	44,45	19,05	25,40	-	3,0	PHP 2-B52TB		
127,0	5,0			137,2	5,4	A-1	1610	146,1	12,70	41,28	44,45	19,05	25,40	-	3,2	PHP 2-B54TB		
132,1	5,2			142,2	5,6	A-1	1610	151,1	12,70	41,28	44,45	19,05	25,40	-	3,7	PHP 2-B56TB		
137,2	5,4			147,3	5,8	A-1	1610	156,2	12,70	41,28	44,45	19,05	25,40	-	3,9	PHP 2-B58TB		
142,2	5,6			152,4	6,0	A-1	1610	161,3	12,70	41,28	44,45	19,05	25,40	-	4,0	PHP 2-B60TB		
147,3	5,8			157,5	6,2	A-1	1610	166,4	12,70	41,28	44,45	19,05	25,40	-	4,1	PHP 2-B62TB		
152,4	6,0			162,6	6,4	A-1	1610	171,5	12,70	41,28	44,45	19,05	25,40	-	4,5	PHP 2-B64TB		
157,5	6,2			167,6	6,6	A-1	1610	176,5	12,70	41,28	44,45	19,05	25,40	-	4,8	PHP 2-B66TB		
162,6	6,4			172,7	6,8	A-1	1610	181,6	12,70	41,28	44,45	19,05	25,40	-	5,0	PHP 2-B68TB		
177,8	7,0			188,0	7,4	A-1	2517 ³⁾	196,9	19,05	63,50	44,45	-	44,45	-	7,3	PHP 2-B74TB		
208,3	8,2			218,4	8,6	A-2	2517 ³⁾	227,3	19,05	63,50	44,45	-	44,45	-	8,2	PHP 2-B86TB		
228,6	9,0			238,8	9,4	A-2	2517 ³⁾	247,7	19,05	63,50	44,45	-	44,45	-	9,1	PHP 2-B94TB		
269,2	10,6			279,4	11,0	A-2	2517 ³⁾	288,3	19,05	63,50	44,45	-	44,45	-	11,3	PHP 2-B110TB		
304,8	12,0			315,0	12,4	A-3	2517 ³⁾	323,9	19,05	63,50	44,45	-	44,45	-	12,3	PHP 2-B124TB		
381,0	15,0			391,2	15,4	A-3	2517 ³⁾	400,1	19,05	63,50	44,45	-	44,45	-	14,1	PHP 2-B154TB		
457,2	18,0			467,4	18,4	A-3	2517 ³⁾	476,3	19,05	63,50	44,45	-	44,45	-	15,0	PHP 2-B184TB		
497,8	19,6			508,0	20,0	C-3	3020	516,9	31,75	76,20	44,45	-	50,80	6,35	22,2	PHP 2-B200TB		
624,8	24,6			635,0	25,0	C-3	3020	643,9	31,75	76,20	44,45	-	50,80	6,35	29,5	PHP 2-B250TB		
751,8	29,6			762,0	30,0	C-3	3020	770,9	31,75	76,20	44,45	-	50,80	6,35	34,0	PHP 2-B300TB		
955,0	37,6			965,2	38,0	C-3	3020	974,1	31,75	76,20	44,45	-	50,80	6,35	50,8	PHP 2-B380TB		

¹⁾ Taper bushing needs to conform to coarse thread series (UNC) of the ASME/ANSI standard. To complete designation, add U before bushing number and bore size at the end of designation, e.g. PHF TBU3535X70MM.

²⁾ Mass does not include bushings.

Classical V-belt pulleys

A/B taper bushed

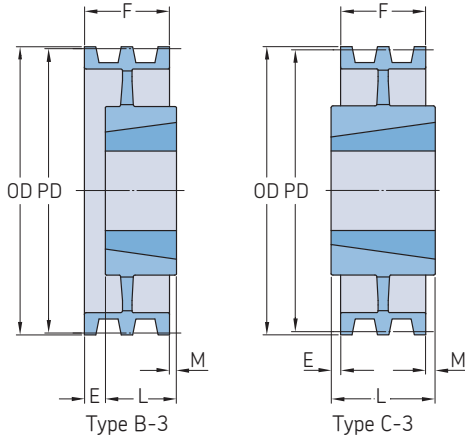

Section	Number of grooves	Pitch diameter Belt A		Belt B		Pulley type	Bushing number	Dimensions				Mass ²⁾	Designation			
		PD	PD	PD	PD			Outer diameter OD	B Min.	Max.	F			E	L	M
		mm	in.	mm	in.	mm										kg
A/B	3	76,2	3,0	86,4	3,4	A-1	1210	95,3	15,88	31,75	63,50	38,10	25,40	-	1,4	PHP 3-B34TB
		81,3	3,2	91,4	3,6	A-1	1210	100,3	15,88	31,75	63,50	38,10	25,40	-	1,6	PHP 3-B36TB
		86,4	3,4	96,5	3,8	A-1	1610	105,4	12,70	41,28	63,50	38,10	25,40	-	1,8	PHP 3-B38TB
		91,4	3,6	101,6	4,0	A-1	1610	110,5	12,70	41,28	63,50	38,10	25,40	-	2,3	PHP 3-B40TB
		96,5	3,8	106,7	4,2	A-1	1610	115,6	12,70	41,28	63,50	38,10	25,40	-	2,7	PHP 3-B42TB
		101,6	4,0	111,8	4,4	A-1	1610	120,7	12,70	41,28	63,50	38,10	25,40	-	3,0	PHP 3-B44TB
		106,7	4,2	116,8	4,6	A-1	1610	125,7	12,70	41,28	63,50	38,10	25,40	-	3,2	PHP 3-B46TB
		111,8	4,4	121,9	4,8	A-1	1610	130,8	12,70	41,28	63,50	38,10	25,40	-	3,6	PHP 3-B48TB
		116,8	4,6	127,0	5,0	A-1	1610	135,9	12,70	41,28	63,50	38,10	25,40	-	3,9	PHP 3-B50TB
		121,9	4,8	132,1	5,2	A-1	1610	141,0	12,70	41,28	63,50	38,10	25,40	-	4,1	PHP 3-B52TB
		127,0	5,0	137,2	5,4	A-1	2517 ¹⁾	146,1	19,05	63,50	63,50	38,10	44,45	-	4,3	PHP 3-B54TB
		132,1	5,2	142,2	5,6	A-1	2517 ¹⁾	151,1	19,05	63,50	63,50	38,10	44,45	-	4,5	PHP 3-B56TB
		137,2	5,4	147,3	5,8	A-1	2517 ¹⁾	156,2	19,05	63,50	63,50	19,05	44,45	-	4,8	PHP 3-B58TB
		142,2	5,6	152,4	6,0	A-1	2517 ¹⁾	161,3	19,05	63,50	63,50	19,05	44,45	-	5,0	PHP 3-B60TB
		147,3	5,8	157,5	6,2	A-1	2517 ¹⁾	166,4	19,05	63,50	63,50	19,05	44,45	-	5,2	PHP 3-B62TB
		152,4	6,0	162,6	6,4	A-1	2517 ¹⁾	171,5	19,05	63,50	63,50	19,05	44,45	-	5,4	PHP 3-B64TB
		157,5	6,2	167,6	6,6	A-1	2517 ¹⁾	176,5	19,05	63,50	63,50	19,05	44,45	-	5,6	PHP 3-B66TB
		162,6	6,4	172,7	6,8	A-1	2517 ¹⁾	181,6	19,05	63,50	63,50	19,05	44,45	-	5,8	PHP 3-B68TB
		177,8	7,0	188,0	7,4	A-1	2517 ¹⁾	196,9	19,05	63,50	63,50	19,05	44,45	-	7,3	PHP 3-B74TB
		208,3	8,2	218,4	8,6	A-2	2517 ¹⁾	227,3	19,05	63,50	63,50	19,05	44,45	-	8,6	PHP 3-B86TB
		228,6	9,0	238,8	9,4	A-2	2517 ¹⁾	247,7	19,05	63,50	63,50	19,05	44,45	-	9,5	PHP 3-B94TB
		269,2	10,6	279,4	11,0	A-2	2517 ¹⁾	288,3	19,05	63,50	63,50	19,05	44,45	-	10,9	PHP 3-B110TB
		304,8	12,0	315,0	12,4	A-3	2517 ¹⁾	323,9	19,05	63,50	63,50	-	44,45	19,05	12,7	PHP 3-B124TB
		381,0	15,0	391,2	15,4	A-3	2517 ¹⁾	400,1	19,05	63,50	63,50	-	44,45	19,05	13,6	PHP 3-B154TB
		457,2	18,0	467,4	18,4	A-3	2517 ¹⁾	476,3	19,05	63,50	63,50	-	44,45	19,05	20,0	PHP 3-B184TB
		497,8	19,6	508,0	20,0	A-3	3020	516,9	31,75	76,20	63,50	-	50,80	12,70	26,3	PHP 3-B200TB
		624,8	24,6	635,0	25,0	A-3	3020	643,9	31,75	76,20	63,50	-	50,80	12,70	33,6	PHP 3-B250TB
		751,8	29,6	762,0	30,0	A-3	3020	770,9	31,75	76,20	63,50	-	50,80	12,70	38,1	PHP 3-B300TB
955,0	37,6	965,2	38,0	B-3	3020	974,1	31,75	76,20	63,50	-	76,20	12,70	61,2	PHP 3-B380TB		
A/B	4	76,2	3,0	86,4	3,4	A-1	1210	95,3	15,88	31,75	82,55	57,15	25,40	-	1,4	PHP 4-B34TB
		81,3	3,2	91,4	3,6	A-1	1210	100,3	15,88	31,75	82,55	57,15	25,40	-	1,6	PHP 4-B36TB
		86,4	3,4	96,5	3,8	A-1	1610	105,4	12,70	41,28	82,55	57,15	25,40	-	1,8	PHP 4-B38TB
		91,4	3,6	101,6	4,0	A-1	1610	110,5	12,70	41,28	82,55	57,15	25,40	-	2,3	PHP 4-B40TB
		96,5	3,8	106,7	4,2	A-1	1610	115,6	12,70	41,28	82,55	57,15	25,40	-	2,5	PHP 4-B42TB
		101,6	4,0	111,8	4,4	A-1	1610	120,7	12,70	41,28	82,55	57,15	25,40	-	2,7	PHP 4-B44TB
		106,7	4,2	116,8	4,6	A-1	1610	125,7	12,70	41,28	82,55	57,15	25,40	-	3,2	PHP 4-B46TB
		111,8	4,4	121,9	4,8	A-1	1610	130,8	12,70	41,28	82,55	57,15	25,40	-	3,6	PHP 4-B48TB
		116,8	4,6	127,0	5,0	A-1	2517 ¹⁾	135,9	19,05	63,50	82,55	38,10	44,45	-	3,9	PHP 4-B50TB
		121,9	4,8	132,1	5,2	A-1	2517 ¹⁾	141,0	19,05	63,50	82,55	38,10	44,45	-	4,1	PHP 4-B52TB
		127,0	5,0	137,2	5,4	A-1	2517 ¹⁾	146,1	19,05	63,50	82,55	38,10	44,45	-	4,3	PHP 4-B54TB
		132,1	5,2	142,2	5,6	A-1	2517 ¹⁾	151,1	19,05	63,50	82,55	38,10	44,45	-	4,5	PHP 4-B56TB
		137,2	5,4	147,3	5,8	A-1	2517 ¹⁾	156,2	19,05	63,50	82,55	38,10	44,45	-	5,4	PHP 4-B58TB
		142,2	5,6	152,4	6,0	A-1	2517 ¹⁾	161,3	19,05	63,50	82,55	38,10	44,45	-	5,7	PHP 4-B60TB
		147,3	5,8	157,5	6,2	A-1	2517 ¹⁾	166,4	19,05	63,50	82,55	38,10	44,45	-	5,9	PHP 4-B62TB
		152,4	6,0	162,6	6,4	A-1	2517 ¹⁾	171,5	19,05	63,50	82,55	38,10	44,45	-	6,4	PHP 4-B64TB
		157,5	6,2	167,6	6,6	A-1	2517 ¹⁾	176,5	19,05	63,50	82,55	38,10	44,45	-	6,8	PHP 4-B66TB
		162,6	6,4	172,7	6,8	A-1	2517 ¹⁾	181,6	19,05	63,50	82,55	38,10	44,45	-	7,3	PHP 4-B68TB
		177,8	7,0	188,0	7,4	A-1	2517 ¹⁾	196,9	19,05	63,50	82,55	38,10	44,45	-	9,1	PHP 4-B74TB
		208,3	8,2	218,4	8,6	A-2	2517 ¹⁾	227,3	19,05	63,50	82,55	38,10	44,45	-	9,5	PHP 4-B86TB
		228,6	9,0	238,8	9,4	A-2	2517 ¹⁾	247,7	19,05	63,50	82,55	38,10	44,45	-	10,4	PHP 4-B94TB
		269,2	10,6	279,4	11,0	A-2	2517 ¹⁾	288,3	19,05	63,50	82,55	38,10	44,45	-	12,7	PHP 4-B110TB
		304,8	12,0	315,0	12,4	A-3	2517 ¹⁾	323,9	19,05	63,50	82,55	9,53	44,45	28,58	15,4	PHP 4-B124TB
		381,0	15,0	391,2	15,4	A-3	2517 ¹⁾	400,1	19,05	63,50	82,55	9,53	44,45	28,58	19,1	PHP 4-B154TB
		457,2	18,0	467,4	18,4	A-3	2517 ¹⁾	476,3	19,05	63,50	82,55	12,70	44,45	25,40	24,0	PHP 4-B184TB

¹⁾ Taper bushing needs to conform to coarse thread series (UNC) of the ASME/ANSI standard. To complete designation, add U before bushing number and bore size at the end of designation, e.g. PHF TBU3535X70MM.

²⁾ Mass does not include bushings.

Classical V-belt pulleys

A/B taper bushed

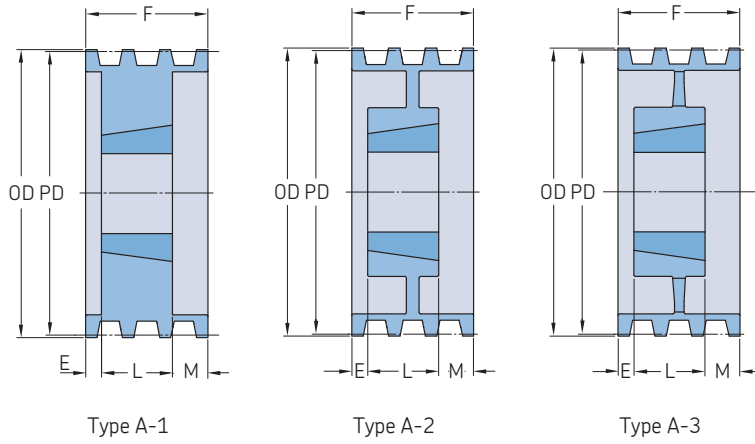

Section	Number of grooves	Pitch diameter Belt A		Belt B		Pulley type	Bushing number	Dimensions				Mass ²⁾	Designation			
		PD	PD	PD	PD			Outer diameter OD	B Min.	Max.	F			E	L	M
		mm	in.	mm	in.	mm						kg				
A/B	4	497,8	19,6	508,0	20,0	A-3	3020	516,9	31,75	76,20	82,55	12,70	50,80	19,05	28,6	PHP 4-B200TB
		624,8	24,6	635,0	25,0	A-3	3030	643,9	31,75	76,20	82,55	-	76,20	31,75	36,3	PHP 4-B250TB
		751,8	29,6	762,0	30,0	A-3	3030	770,9	31,75	76,20	82,55	-	76,20	31,75	45,4	PHP 4-B300TB
		955,0	37,6	965,2	38,0	A-3	3030	974,1	31,75	76,20	82,55	-	76,20	31,75	64,4	PHP 4-B380TB
A/B	5	76,2	3,0	86,4	3,4	A-1	1210	95,3	15,88	31,75	101,60	63,50	38,10	-	2,3	PHP 5-B34TB
		81,3	3,2	91,4	3,6	A-1	1210	100,3	15,88	31,75	101,60	63,50	38,10	-	2,5	PHP 5-B36TB
		86,4	3,4	96,5	3,8	A-1	1215	105,4	15,88	41,28	101,60	63,50	38,10	-	2,7	PHP 5-B38TB
		91,4	3,6	101,6	4,0	A-1	1215	110,5	15,88	41,28	101,60	63,50	38,10	-	3,0	PHP 5-B40TB
		96,5	3,8	106,7	4,2	A-1	1615	115,6	12,70	41,28	101,60	63,50	38,10	-	3,2	PHP 5-B42TB
		101,6	4,0	111,8	4,4	A-1	1615	120,7	12,70	41,28	101,60	63,50	38,10	-	3,6	PHP 5-B44TB
		106,7	4,2	116,8	4,6	A-1	1615	125,7	12,70	41,28	101,60	63,50	38,10	-	4,1	PHP 5-B46TB
		116,8	4,6	127,0	5,0	A-1	1615	135,9	12,70	41,28	101,60	22,23	38,10	-	4,8	PHP 5-B50TB
		121,9	4,8	132,1	5,2	A-1	1615	141,0	12,70	41,28	101,60	22,23	38,10	-	5,1	PHP 5-B52TB
		127,0	5,0	137,2	5,4	A-1	2517 ³⁾	146,1	19,05	63,50	101,60	57,15	44,45	-	5,2	PHP 5-B54TB
		132,1	5,2	142,2	5,6	A-1	2517 ³⁾	151,1	19,05	63,50	101,60	57,15	44,45	-	5,4	PHP 5-B56TB
		142,2	5,6	152,4	6,0	A-1	2517 ³⁾	161,3	19,05	63,50	101,60	57,15	44,45	-	6,4	PHP 5-B60TB
		152,4	6,0	162,6	6,4	A-1	2517 ³⁾	171,5	19,05	63,50	101,60	57,15	44,45	-	7,3	PHP 5-B64TB
		162,6	6,4	172,7	6,8	A-1	2517 ³⁾	181,6	19,05	63,50	101,60	57,15	44,45	-	8,2	PHP 5-B68TB
		177,8	7,0	188,0	7,4	A-1	2517 ³⁾	196,9	19,05	63,50	101,60	57,15	44,45	-	10,0	PHP 5-B74TB
		208,3	8,2	218,4	8,6	A-2	2517 ³⁾	227,3	19,05	63,50	101,60	57,15	44,45	-	10,9	PHP 5-B86TB
		228,6	9,0	238,8	9,4	A-2	2517 ³⁾	247,7	19,05	63,50	101,60	57,15	44,45	-	11,8	PHP 5-B94TB
		269,2	10,6	279,4	11,0	A-2	2517 ³⁾	288,3	19,05	63,50	101,60	57,15	44,45	-	15,9	PHP 5-B110TB
		304,8	12,0	315,0	12,4	A-3	2517 ³⁾	323,9	19,05	63,50	101,60	19,05	44,45	38,10	18,1	PHP 5-B124TB
		381,0	15,0	391,2	15,4	A-3	2517 ³⁾	400,1	19,05	63,50	101,60	19,05	44,45	38,10	21,3	PHP 5-B154TB
457,2	18,0	467,4	18,4	A-3	2517 ³⁾	476,3	19,05	63,50	101,60	19,05	44,45	38,10	23,6	PHP 5-B184TB		
497,8	19,6	508,0	20,0	A-3	3030	516,9	31,75	76,20	101,60	6,35	76,20	19,05	34,0	PHP 5-B200TB		
624,8	24,6	635,0	25,0	A-3	3030	643,9	31,75	76,20	101,60	6,35	76,20	19,05	36,7	PHP 5-B250TB		
751,8	29,6	762,0	30,0	A-3	3030	770,9	31,75	76,20	101,60	6,35	76,20	19,05	49,4	PHP 5-B300TB		
955,0	37,6	965,2	38,0	A-3	3030	974,1	31,75	76,20	101,60	6,35	76,20	19,05	71,7	PHP 5-B380TB		
A/B	6	96,5	3,8	106,7	4,2	A-1	1615	115,6	12,70	41,28	120,65	82,55	38,10	-	3,6	PHP 6-B42TB
		101,6	4,0	111,8	4,4	A-1	1615	120,7	12,70	41,28	120,65	82,55	38,10	-	4,1	PHP 6-B44TB
		106,7	4,2	116,8	4,6	A-1	1615	125,7	12,70	41,28	120,65	82,55	38,10	-	4,5	PHP 6-B46TB
		116,8	4,6	127,0	5,0	A-1	1615	135,9	12,70	41,28	120,65	31,75	38,10	50,80	5,4	PHP 6-B50TB
		121,9	4,8	132,1	5,2	A-1	1615	141,0	12,70	41,28	120,65	31,75	38,10	50,80	5,8	PHP 6-B52TB
		127,0	5,0	137,2	5,4	A-1	1615	146,1	12,70	41,28	120,65	31,75	38,10	50,80	6,2	PHP 6-B54TB
		132,1	5,2	142,2	5,6	A-1	1615	151,1	12,70	41,28	120,65	31,75	38,10	50,80	6,6	PHP 6-B56TB
		142,2	5,6	152,4	6,0	A-1	2517 ³⁾	161,3	19,05	63,50	120,65	76,20	44,45	-	7,3	PHP 6-B60TB
		152,4	6,0	162,6	6,4	A-1	2517 ³⁾	171,5	19,05	63,50	120,65	76,20	44,45	-	8,9	PHP 6-B64TB
		162,6	6,4	172,7	6,8	A-1	2517 ³⁾	181,6	19,05	63,50	120,65	76,20	44,45	-	9,5	PHP 6-B68TB
		177,8	7,0	188,0	7,4	A-1	2517 ³⁾	196,9	19,05	63,50	120,65	76,20	44,45	-	11,3	PHP 6-B74TB
		208,3	8,2	218,4	8,6	A-2	2517 ³⁾	227,3	19,05	63,50	120,65	76,20	44,45	-	12,3	PHP 6-B86TB
		228,6	9,0	238,8	9,4	A-2	2517 ³⁾	247,7	19,05	63,50	120,65	76,20	44,45	-	12,7	PHP 6-B94TB
		269,2	10,6	279,4	11,0	A-2	2517 ³⁾	288,3	19,05	63,50	120,65	76,20	44,45	-	15,4	PHP 6-B110TB
		304,8	12,0	315,0	12,4	A-3	2517 ³⁾	323,9	19,05	63,50	120,65	28,58	44,45	47,63	19,5	PHP 6-B124TB
		381,0	15,0	391,2	15,4	A-3	2517 ³⁾	400,1	19,05	63,50	120,65	38,10	44,45	38,10	23,6	PHP 6-B154TB
		457,2	18,0	467,4	18,4	A-3	2517 ³⁾	476,3	19,05	63,50	120,65	38,10	44,45	38,10	28,1	PHP 6-B184TB
		497,8	19,6	508,0	20,0	A-3	3030	516,9	31,75	76,20	120,65	12,70	76,20	31,75	38,6	PHP 6-B200TB
		624,8	24,6	635,0	25,0	A-3	3030	643,9	31,75	76,20	120,65	12,70	76,20	31,75	45,4	PHP 6-B250TB
		751,8	29,6	762,0	30,0	A-3	3030	770,9	31,75	76,20	120,65	12,70	76,20	31,75	58,6	PHP 6-B300TB
955,0	37,6	965,2	38,0	A-3	3030	974,1	31,75	76,20	120,65	12,70	76,20	31,75	62,1	PHP 6-B380TB		
A/B	8	127,0	5,0	137,2	5,4	A-1	2517 ³⁾	146,1	19,05	63,50	158,75	47,63	44,45	66,68	7,3	PHP 8-B54TB
		132,1	5,2	142,2	5,6	A-1	2517 ³⁾	151,1	19,05	63,50	158,75	47,63	44,45	66,68	7,7	PHP 8-B56TB
		142,2	5,6	152,4	6,0	A-1	2517 ³⁾	161,3	19,05	63,50	158,75	47,63	44,45	66,68	8,6	PHP 8-B60TB

¹⁾ Taper bushing needs to conform to coarse thread series (UNC) of the ASME/ANSI standard. To complete designation, add U before bushing number and bore size at the end of designation, e.g. PHF TBU3535X70MM.

²⁾ Mass does not include bushings.

Classical V-belt pulleys

A/B taper bushed

Section	Number of grooves	Pitch diameter Belt A		Belt B		Pulley type	Bushing number	Dimensions					Mass ²⁾	Designation				
		PD	PD	PD	PD			Outer diameter OD	B Min.	Max.	F	E			L	M		
–	–	mm	in.	mm	in.			mm						kg				
A/B	8	152,4	6,0	162,6	6,4	A-1	2517 ¹⁾	171,5	19,05	63,50	158,75	47,63	44,45	66,68	9,5	PHP 8-B64TB		
		162,6	6,4	172,7	6,8	A-1	2517 ¹⁾	181,6	19,05	63,50	158,75	47,63	44,45	66,68	11,3	PHP 8-B68TB		
		177,8	7,0	188,0	7,4	A-1	2517 ¹⁾	196,9	19,05	63,50	158,75	47,63	44,45	66,68	13,2	PHP 8-B74TB		
		208,3	8,2	218,4	8,6	A-1	3030	227,3	31,75	76,20	158,75	25,40	76,20	57,15	16,8	PHP 8-B86TB		
		228,6	9,0	238,8	9,4	A-2	3030	252,7	31,75	76,20	158,75	25,40	76,20	57,15	18,6	PHP 8-B94TB		
		269,2	10,6	279,4	11,0	A-2	3030	288,3	31,75	76,20	158,75	25,40	76,20	57,15	23,1	PHP 8-B110TB		
		304,8	12,0	315,0	12,4	A-3	3030	323,9	31,75	76,20	158,75	25,40	76,20	57,15	25,4	PHP 8-B124TB		
		381,0	15,0	391,2	15,4	A-3	3030	400,1	31,75	76,20	158,75	25,40	76,20	57,15	31,3	PHP 8-B154TB		
		457,2	18,0	467,4	18,4	A-3	3030	476,3	31,75	76,20	158,75	25,40	76,20	57,15	44,9	PHP 8-B184TB		
		497,8	19,6	508,0	20,0	A-3	3030	516,9	31,75	76,20	158,75	25,40	76,20	57,15	52,2	PHP 8-B200TB		
		624,8	24,6	635,0	25,0	A-3	3535 ¹⁾	643,9	50,80	88,90	158,75	19,05	88,90	50,80	65,8	PHP 8-B250TB		
		751,8	29,6	762,0	30,0	A-3	3535 ¹⁾	770,9	50,80	88,90	158,75	19,05	88,90	50,80	77,1	PHP 8-B300TB		
		955,0	37,6	965,2	38,0	A-3	4040	974,1	44,45	101,60	158,75	28,58	101,60	28,58	117,9	PHP 8-B380TB		
		A/B	10	127,0	5,0	137,2	5,4	A-1	2517 ¹⁾	146,1	19,05	63,50	196,85	76,20	44,45	76,20	8,2	PHP 10-B54TB
				132,1	5,2	142,2	5,6	A-1	2517 ¹⁾	151,1	19,05	63,50	196,85	76,20	44,45	76,20	9,1	PHP 10-B56TB
				142,2	5,6	152,4	6,0	A-1	2517 ¹⁾	161,3	19,05	63,50	196,85	76,20	44,45	76,20	10,0	PHP 10-B60TB
152,4	6,0			162,6	6,4	A-1	2517 ¹⁾	171,5	19,05	63,50	196,85	76,20	44,45	76,20	11,6	PHP 10-B64TB		
162,6	6,4			172,7	6,8	A-1	2517 ¹⁾	181,6	19,05	63,50	196,85	76,20	44,45	76,20	12,7	PHP 10-B68TB		
177,8	7,0			188,0	7,4	A-1	2517 ¹⁾	196,9	19,05	63,50	196,85	76,20	44,45	76,20	15,9	PHP 10-B74TB		
208,3	8,2			218,4	8,6	A-1	3030	227,3	31,75	76,20	196,85	50,80	76,20	69,85	19,5	PHP 10-B86TB		
228,6	9,0			238,8	9,4	A-2	3030	252,7	31,75	76,20	196,85	50,80	76,20	69,85	20,9	PHP 10-B94TB		
269,2	10,6			279,4	11,0	A-2	3030	288,3	31,75	76,20	196,85	50,80	76,20	69,85	23,6	PHP 10-B110TB		

¹⁾ Taper bushing needs to conform to coarse thread series (UNC) of the ASME/ANSI standard. To complete designation, add U before bushing number and bore size at the end of designation, e.g. PHF TBU3535X70MM.

²⁾ Mass does not include bushings.

Classical V-belt pulleys

C taper bushed

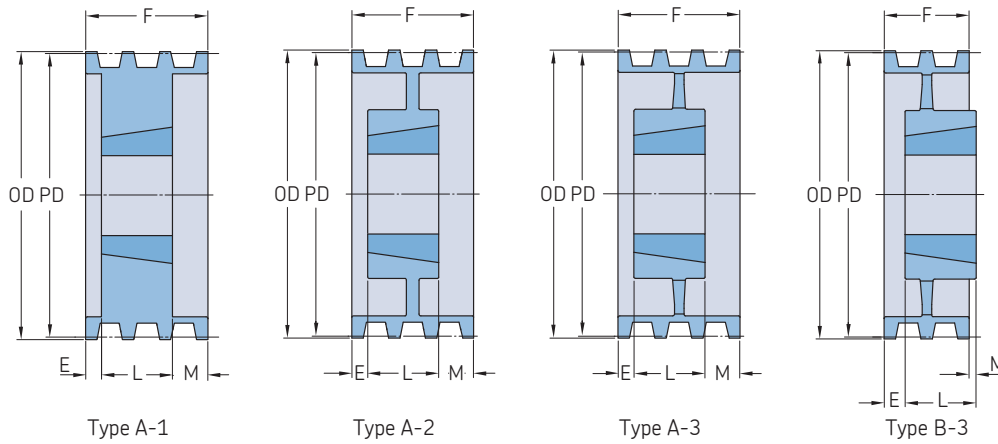

Section	Number of grooves	Pitch diameter		Pulley type	Bushing number	Dimensions		B Min.	Max.	F	E	L	M	Mass ²⁾	Designation
		PD	mm			in.	Outer diameter								
			mm											kg	
C	2	177,8	7,0	A-1	2517 ¹⁾	188,0	19,05	63,50	60,33	15,88	44,45	-	6,8	PHP 2-C70TB	
		190,5	7,5	A-1	2517 ¹⁾	200,7	19,05	63,50	60,33	15,88	44,45	-	7,7	PHP 2-C75TB	
		203,2	8,0	A-1	2517 ¹⁾	213,4	19,05	63,50	60,33	15,88	44,45	-	9,1	PHP 2-C80TB	
		215,9	8,5	A-2	2517 ¹⁾	226,1	19,05	63,50	60,33	15,88	44,45	-	10,0	PHP 2-C85TB	
		228,6	9,0	A-2	2517 ¹⁾	238,8	19,05	63,50	60,33	15,88	44,45	-	10,4	PHP 2-C90TB	
		241,3	9,5	A-2	2517 ¹⁾	251,5	19,05	63,50	60,33	15,88	44,45	-	10,9	PHP 2-C95TB	
		254,0	10,0	A-2	2517 ¹⁾	264,2	19,05	63,50	60,33	15,88	44,45	-	11,3	PHP 2-C100TB	
		266,7	10,5	A-2	2517 ¹⁾	276,9	19,05	63,50	60,33	15,88	44,45	-	11,8	PHP 2-C105TB	
		279,4	11,0	A-2	2517 ¹⁾	289,6	19,05	63,50	60,33	15,88	44,45	-	12,3	PHP 2-C110TB	
		304,8	12,0	A-2	2517 ¹⁾	315,0	19,05	63,50	60,33	15,88	44,45	-	15,0	PHP 2-C120TB	
		330,2	13,0	A-3	2517 ¹⁾	340,4	19,05	63,50	60,33	15,88	44,45	-	15,9	PHP 2-C130TB	
		355,6	14,0	A-3	2517 ¹⁾	365,8	19,05	63,50	60,33	15,88	44,45	-	16,3	PHP 2-C140TB	
		406,4	16,0	A-3	2517 ¹⁾	416,6	19,05	63,50	60,33	15,88	44,45	-	19,1	PHP 2-C160TB	
		457,2	18,0	A-3	3020	467,4	31,75	76,20	60,33	-	50,80	9,53	19,1	PHP 2-C180TB	
		508,0	20,0	A-3	3020	518,2	31,75	76,20	60,33	-	50,80	9,53	20,4	PHP 2-C200TB	
		609,6	24,0	A-3	3020	619,8	31,75	76,20	60,33	-	50,80	9,53	32,7	PHP 2-C240TB	
C	3	177,8	7,0	A-1	2517 ¹⁾	188,0	19,05	63,50	85,73	6,35	44,45	34,93	8,2	PHP 3-C70TB	
		190,5	7,5	A-1	2517 ¹⁾	200,7	19,05	63,50	85,73	6,35	44,45	34,93	9,1	PHP 3-C75TB	
		203,2	8,0	A-1	2517 ¹⁾	213,4	19,05	63,50	85,73	6,35	44,45	34,93	10,0	PHP 3-C80TB	
		215,9	8,5	A-2	2517 ¹⁾	226,1	19,05	63,50	85,73	6,35	44,45	34,93	10,4	PHP 3-C85TB	
		228,6	9,0	A-2	2517 ¹⁾	238,8	19,05	63,50	85,73	6,35	44,45	34,93	10,9	PHP 3-C90TB	
		241,3	9,5	A-2	2517 ¹⁾	251,5	19,05	63,50	85,73	6,35	44,45	34,93	12,3	PHP 3-C95TB	
		254,0	10,0	A-2	2517 ¹⁾	264,2	19,05	63,50	85,73	6,35	44,45	34,93	13,2	PHP 3-C100TB	
		266,7	10,5	A-2	2517 ¹⁾	276,9	19,05	63,50	85,73	6,35	44,45	34,93	14,5	PHP 3-C105TB	
		279,4	11,0	A-2	2517 ¹⁾	289,6	19,05	63,50	85,73	6,35	44,45	34,93	15,9	PHP 3-C110TB	
		304,8	12,0	A-2	3020	315,0	31,75	76,20	85,73	-	50,80	34,93	20,0	PHP 3-C120TB	
		330,2	13,0	A-3	3020	340,4	31,75	76,20	85,73	-	50,80	34,93	22,2	PHP 3-C130TB	
		355,6	14,0	A-3	3020	365,8	31,75	76,20	85,73	-	50,80	34,93	22,7	PHP 3-C140TB	
		406,4	16,0	A-3	3020	416,6	31,75	76,20	85,73	-	50,80	34,93	29,0	PHP 3-C160TB	
		457,2	18,0	A-3	3030	467,4	31,75	76,20	85,73	-	76,20	9,53	29,0	PHP 3-C180TB	
		508,0	20,0	A-3	3030	518,2	31,75	76,20	85,73	-	76,20	9,53	35,4	PHP 3-C200TB	
		609,6	24,0	A-3	3030	619,8	31,75	76,20	85,73	-	76,20	9,53	43,5	PHP 3-C240TB	
		762,0	30,0	B-3	3535 ¹⁾	772,2	50,80	88,90	85,73	-	88,90	3,18	56,7	PHP 3-C300TB	
		914,4	36,0	B-3	3535 ¹⁾	924,6	50,80	88,90	85,73	-	88,90	3,18	79,4	PHP 3-C360TB	
C	4	177,8	7,0	A-1	2517 ¹⁾	188,0	19,05	63,50	111,13	12,70	44,45	53,98	9,1	PHP 4-C70TB	
		190,5	7,5	A-1	2517 ¹⁾	200,7	19,05	63,50	111,13	12,70	44,45	53,98	10,4	PHP 4-C75TB	
		203,2	8,0	A-1	2517 ¹⁾	213,4	19,05	63,50	111,13	12,70	44,45	53,98	11,3	PHP 4-C80TB	
		215,9	8,5	A-2	2517 ¹⁾	226,1	19,05	63,50	111,13	12,70	44,45	53,98	11,8	PHP 4-C85TB	
		228,6	9,0	A-2	2517 ¹⁾	238,8	19,05	63,50	111,13	12,70	44,45	53,98	12,3	PHP 4-C90TB	
		241,3	9,5	A-2	2517 ¹⁾	251,5	19,05	63,50	111,13	12,70	44,45	53,98	16,3	PHP 4-C95TB	
		254,0	10,0	A-2	2517 ¹⁾	264,2	19,05	63,50	111,13	12,70	44,45	53,98	17,7	PHP 4-C100TB	
		266,7	10,5	A-2	2517 ¹⁾	276,9	19,05	63,50	111,13	12,70	44,45	53,98	19,1	PHP 4-C105TB	
		279,4	11,0	A-2	2517 ¹⁾	289,6	19,05	63,50	111,13	12,70	44,45	53,98	20,4	PHP 4-C110TB	
		304,8	12,0	A-2	2517 ¹⁾	315,0	19,05	76,20	111,13	-	76,20	34,93	21,3	PHP 4-C120TB	
		330,2	13,0	A-3	3030	340,4	31,75	76,20	111,13	-	76,20	34,93	23,1	PHP 4-C130TB	
		355,6	14,0	A-3	3030	365,8	31,75	76,20	111,13	-	76,20	34,93	24,5	PHP 4-C140TB	
		406,4	16,0	A-3	3030	416,6	31,75	76,20	111,13	-	76,20	34,93	32,2	PHP 4-C160TB	
		457,2	18,0	A-3	3030	467,4	31,75	76,20	111,13	-	76,20	34,93	36,7	PHP 4-C180TB	
		508,0	20,0	A-3	3030	518,2	31,75	76,20	111,13	-	76,20	34,93	38,1	PHP 4-C200TB	
		609,6	24,0	A-3	3030	619,8	31,75	76,20	111,13	-	76,20	34,93	52,6	PHP 4-C240TB	
		762,0	30,0	A-3	3535 ¹⁾	772,2	50,80	88,90	111,13	-	88,90	22,23	74,4	PHP 4-C300TB	
		914,4	36,0	A-3	3535 ¹⁾	924,6	50,80	88,90	111,13	-	88,90	22,23	87,1	PHP 4-C360TB	
		1117,6	44,0	A-3	4040	1127,8	44,45	101,60	111,13	-	101,60	9,53	127,9	PHP 4-C440TB	

¹⁾ Taper bushing needs to conform to coarse thread series (UNC) of the ASME/ANSI standard. To complete designation, add U before bushing number and bore size at the end of designation, e.g. PHF TBU3535X70MM.

²⁾ Mass does not include bushings.

Classical V-belt pulleys

C taper bushed | D taper bushed

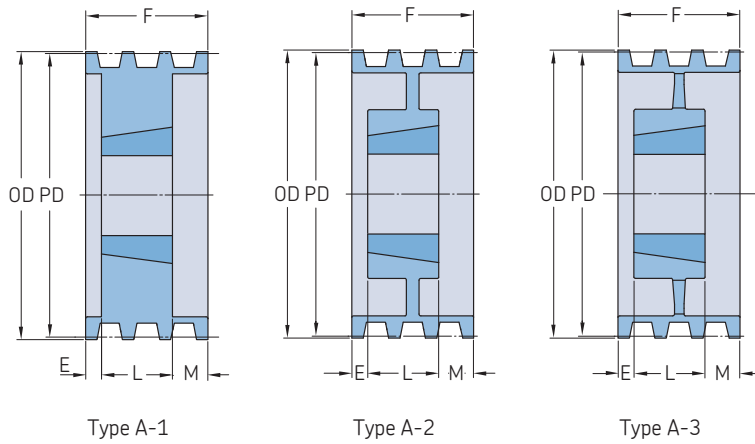

Section	Number of grooves	Pitch diameter		Pulley type	Bushing number	Dimensions		F	E	L	M	Mass ²⁾	Designation	
		PD				Outer diameter OD	B Min.							Max.
		mm	in.			mm							kg	
C	12	266,7	10,5	A-1	4040	276,9	44,45	101,60	314,33	88,90	101,60	123,83	43,1	PHP 12-C105TB
		279,4	11,0	A-1	4040	289,6	44,45	101,60	314,33	88,90	101,60	123,83	47,2	PHP 12-C110TB
		304,8	12,0	A-1	4040	315,0	44,45	101,60	314,33	88,90	101,60	123,83	57,2	PHP 12-C120TB
		330,2	13,0	A-1	4545	340,4	57,15	114,30	314,33	76,20	114,30	123,83	70,8	PHP 12-C130TB
		355,6	14,0	A-1	4545	365,8	57,15	114,30	314,33	76,20	114,30	123,83	83,5	PHP 12-C140TB
D	4	304,8	12,0	A-2	3535 ¹⁾	320,0	50,80	88,90	153,99	19,05	88,90	46,04	28,6	PHP 4-D120TB
		330,2	13,0	A-2	3535 ¹⁾	345,4	50,80	88,90	153,99	19,05	88,90	46,04	33,1	PHP 4-D130TB
		342,9	13,5	A-2	3535 ¹⁾	358,1	50,80	88,90	153,99	19,05	88,90	46,04	35,4	PHP 4-D135TB
		355,6	14,0	A-2	3535 ¹⁾	370,8	50,80	88,90	153,99	19,05	88,90	46,04	37,7	PHP 4-D140TB
		368,3	14,5	A-2	3535 ¹⁾	383,5	50,80	88,90	153,99	19,05	88,90	46,04	42,6	PHP 4-D145TB
		381,0	15,0	A-2	3535 ¹⁾	396,2	50,80	88,90	153,99	19,05	88,90	46,04	42,6	PHP 4-D150TB
		393,7	15,5	A-2	3535 ¹⁾	408,9	50,80	88,90	153,99	19,05	88,90	46,04	44,9	PHP 4-D155TB
		406,4	16,0	A-2	3535 ¹⁾	421,6	50,80	88,90	153,99	19,05	88,90	46,04	47,2	PHP 4-D160TB
		457,2	18,0	A-3	3535 ¹⁾	472,4	50,80	88,90	153,99	19,05	88,90	46,04	49,4	PHP 4-D180TB
		558,8	22,0	A-3	4040	574,0	44,45	101,60	153,99	19,05	101,60	33,34	64,4	PHP 4-D220TB
		685,8	27,0	A-3	4040	701,0	44,45	101,60	153,99	19,05	101,60	33,34	82,6	PHP 4-D270TB
		D	5	304,8	12,0	A-1	4040	320,0	44,45	101,60	190,50	6,35	101,60	69,85
330,2	13,0			A-2	4040	345,4	44,45	101,60	190,50	19,05	101,60	69,85	39,5	PHP 5-D130TB
342,9	13,5			A-2	4040	358,1	44,45	101,60	190,50	19,05	101,60	69,85	41,7	PHP 5-D135TB
355,6	14,0			A-2	4040	370,8	44,45	101,60	190,50	19,05	101,60	69,85	44,0	PHP 5-D140TB
368,3	14,5			A-2	4040	383,5	44,45	101,60	190,50	19,05	101,60	69,85	46,3	PHP 5-D145TB
381,0	15,0			A-2	4040	396,2	44,45	101,60	190,50	19,05	101,60	69,85	48,5	PHP 5-D150TB
393,7	15,5			A-2	4040	408,9	44,45	101,60	190,50	19,05	101,60	69,85	50,8	PHP 5-D155TB
406,4	16,0			A-2	4040	421,6	44,45	101,60	190,50	19,05	101,60	69,85	50,8	PHP 5-D160TB
457,2	18,0			A-3	4040	472,4	44,45	101,60	190,50	25,40	101,60	63,50	59,9	PHP 5-D180TB
558,8	22,0			A-3	4040	574,0	44,45	101,60	190,50	25,40	101,60	63,50	73,5	PHP 5-D220TB
685,8	27,0			A-3	4040	701,0	44,45	101,60	190,50	25,40	101,60	63,50	93,9	PHP 5-D270TB
D	6			304,8	12,0	A-1	4040	320,0	44,45	101,60	227,01	25,40	101,60	100,01
		330,2	13,0	A-2	4040	345,4	44,45	101,60	227,01	38,10	101,60	87,31	45,4	PHP 6-D130TB
		342,9	13,5	A-2	4040	358,1	44,45	101,60	227,01	38,10	101,60	87,31	48,5	PHP 6-D135TB
		355,6	14,0	A-2	4040	370,8	44,45	101,60	227,01	38,10	101,60	87,31	50,8	PHP 6-D140TB
		368,3	14,5	A-2	4040	383,5	44,45	101,60	227,01	38,10	101,60	87,31	53,1	PHP 6-D145TB
		381,0	15,0	A-2	4040	396,2	44,45	101,60	227,01	38,10	101,60	87,31	55,3	PHP 6-D150TB
		393,7	15,5	A-2	4040	408,9	44,45	101,60	227,01	38,10	101,60	87,31	57,6	PHP 6-D155TB
		406,4	16,0	A-2	4040	421,6	44,45	101,60	227,01	38,10	101,60	87,31	79,4	PHP 6-D160TB
		457,2	18,0	A-2	4040	472,4	44,45	101,60	227,01	38,10	101,60	87,31	83,9	PHP 6-D180TB
		558,8	22,0	A-3	4040	574,0	44,45	101,60	227,01	38,10	101,60	87,31	95,3	PHP 6-D220TB
		685,8	27,0	A-3	4545	701,0	57,15	114,30	227,01	44,45	114,30	68,26	117,9	PHP 6-D270TB
		838,2	33,0	A-3	4545	853,4	57,15	114,30	227,01	44,45	114,30	68,26	154,2	PHP 6-D330TB
D	8	304,8	12,0	A-1	4545	320,0	57,15	114,30	300,04	12,70	114,30	173,04	56,7	PHP 8-D120TB
		330,2	13,0	A-1	4545	345,4	57,15	114,30	300,04	12,70	114,30	173,04	70,3	PHP 8-D130TB
		342,9	13,5	A-2	4545	358,1	57,15	114,30	300,04	25,40	114,30	160,34	68,0	PHP 8-D135TB
		355,6	14,0	A-1	4545	370,8	57,15	114,30	300,04	25,40	114,30	160,34	70,3	PHP 8-D140TB
		368,3	14,5	A-2	4545	383,5	57,15	114,30	300,04	50,80	114,30	134,94	70,3	PHP 8-D145TB
		381,0	15,0	A-2	4545	396,2	57,15	114,30	300,04	50,80	114,30	134,94	61,2	PHP 8-D150TB
		393,7	15,5	A-2	4545	408,9	57,15	114,30	300,04	50,80	114,30	134,94	74,8	PHP 8-D155TB
		406,4	16,0	A-2	4545	421,6	57,15	114,30	300,04	50,80	114,30	134,94	74,8	PHP 8-D160TB
		457,2	18,0	A-2	4545	472,4	57,15	114,30	300,04	69,85	114,30	115,89	81,7	PHP 8-D180TB
		558,8	22,0	A-3	4545	574,0	57,15	114,30	300,04	69,85	114,30	115,89	124,7	PHP 8-D220TB
		685,8	27,0	A-3	4545	701,0	57,15	114,30	300,04	69,85	114,30	115,89	156,5	PHP 8-D270TB
		838,2	33,0	A-3	4545	853,4	57,15	114,30	300,04	69,85	114,30	115,89	206,4	PHP 8-D330TB

¹⁾ Taper bushing needs to conform to coarse thread series (UNC) of the ASME/ANSI standard. To complete designation, add U before bushing number and bore size at the end of designation, e.g. PHF TBU3535X70MM.

²⁾ Mass does not include bushings.

Classical V-belt pulleys

D taper bushed

Section	Number of grooves	Pitch diameter		Pulley type	Bushing number	Dimensions					Mass*	Designation		
		PD				Outer diameter	B		F	E			L	M
		mm	in.			mm	Min.	Max.						
–	–	–	–	–	–	–	–	–	–	–	–	–	–	–
D	10	304,8	12,0	A-1	4545	320,0	57,15	114,30	373,06	60,33	114,30	198,44	63,5	PHP 10-D120TB
		330,2	13,0	A-1	4545	345,4	57,15	114,30	373,06	60,33	114,30	198,44	77,1	PHP 10-D130TB
		342,9	13,5	A-2	4545	358,1	57,15	114,30	373,06	60,33	114,30	198,44	77,1	PHP 10-D135TB
		355,6	14,0	A-2	4545	370,8	57,15	114,30	373,06	60,33	114,30	198,44	79,4	PHP 10-D140TB
		368,3	14,5	A-2	4545	383,5	57,15	114,30	373,06	60,33	114,30	198,44	81,7	PHP 10-D145TB
		381,0	15,0	A-2	4545	396,2	57,15	114,30	373,06	60,33	114,30	198,44	88,5	PHP 10-D150TB
		393,7	15,5	A-2	4545	408,9	57,15	114,30	373,06	60,33	114,30	198,44	79,4	PHP 10-D155TB
		406,4	16,0	A-2	4545	421,6	57,15	114,30	373,06	60,33	114,30	198,44	88,5	PHP 10-D160TB
		457,2	18,0	A-2	4545	472,4	57,15	114,30	373,06	101,60	114,30	157,16	88,5	PHP 10-D180TB
		558,8	22,0	A-3	4545	574,0	57,15	114,30	373,06	101,60	114,30	157,16	154,2	PHP 10-D220TB
		685,8	27,0	A-3	4545	701,0	57,15	114,30	373,06	101,60	114,30	157,16	188,2	PHP 10-D270TB
		838,2	33,0	A-3	4545	853,4	57,15	114,30	373,06	107,95	114,30	150,81	220,0	PHP 10-D330TB

* Mass does not include bushings.

Classical V-belt pulleys

A/B QD bushed

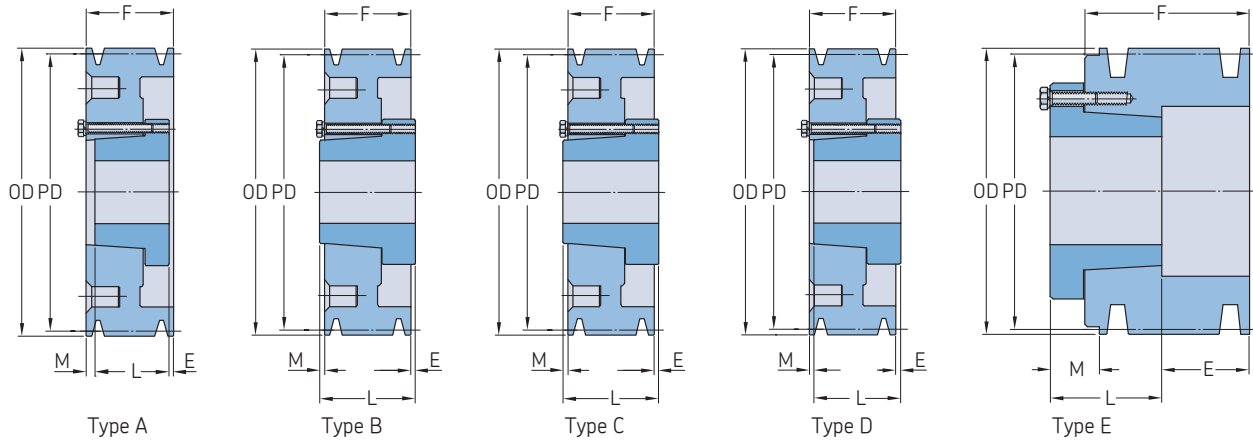

Section	Number of grooves	Pitch diameter Belt A		Belt B		Pulley type ¹⁾	Bushing number	Dimensions			E	F	L	M	Mass ²⁾	Designation		
		PD	PD	PD	PD			Outer diameter OD	Bore Min.	Max.								
-	-	mm	in.	mm	in.	-	-	mm						kg	-			
A/B	1	76,2	3,0	86,4	3,4	E-1	SH	95,25	12,70	41,28	5,56	22,23	33,34	16,67	0,9	PHP 1-B34-SH		
		81,3	3,2	91,4	3,6	D-1	SH	100,33	12,70	41,28	15,08	22,23	33,34	3,97	1,0	PHP 1-B36-SH		
		86,4	3,4	96,5	3,8	D-1	SH	105,41	12,70	41,28	15,08	22,23	33,34	3,97	1,1	PHP 1-B38-SH		
		91,4	3,6	101,6	4,0	C-1	SH	110,49	12,70	41,28	8,73	22,23	33,34	2,38	1,2	PHP 1-B40-SH		
		96,5	3,8	106,7	4,2	C-1	SH	115,57	12,70	41,28	8,73	22,23	33,34	2,38	1,3	PHP 1-B42-SH		
		101,6	4,0	111,8	4,4	C-1	SH	120,65	12,70	41,28	8,73	22,23	33,34	2,38	1,5	PHP 1-B44-SH		
		106,7	4,2	116,8	4,6	C-1	SDS	125,73	12,70	50,80	8,73	22,23	33,34	2,38	1,8	PHP 1-B46-SDS		
		111,8	4,4	121,9	4,8	C-1	SDS	130,81	12,70	50,80	8,73	22,23	33,34	2,38	2,0	PHP 1-B48-SDS		
		116,8	4,6	127,0	5,0	C-1	SDS	135,89	12,70	50,80	8,73	22,23	33,34	2,38	2,1	PHP 1-B50-SDS		
		121,9	4,8	132,1	5,2	C-1	SDS	140,97	12,70	50,80	8,73	22,23	33,34	2,38	2,3	PHP 1-B52-SDS		
		127,0	5,0	137,2	5,4	C-1	SDS	146,05	12,70	50,80	8,73	22,23	33,34	2,38	2,4	PHP 1-B54-SDS		
		132,1	5,2	142,2	5,6	C-1	SDS	151,13	12,70	50,80	8,73	22,23	33,34	2,38	2,5	PHP 1-B56-SDS		
		137,2	5,4	147,3	5,8	C-2	SDS	156,21	12,70	50,80	8,73	22,23	33,34	2,38	2,7	PHP 1-B58-SDS		
		142,2	5,6	152,4	6,0	C-2	SDS	161,29	12,70	50,80	8,73	22,23	33,34	2,38	2,8	PHP 1-B60-SDS		
		147,3	5,8	157,5	6,2	C-2	SDS	166,37	12,70	50,80	8,73	22,23	33,34	2,38	3,0	PHP 1-B62-SDS		
		152,4	6,0	162,6	6,4	C-2	SDS	171,45	12,70	50,80	8,73	22,23	33,34	2,38	3,1	PHP 1-B64-SDS		
		157,5	6,2	167,6	6,6	C-2	SDS	176,53	12,70	50,80	8,73	22,23	33,34	2,38	3,3	PHP 1-B66-SDS		
		162,6	6,4	172,7	6,8	C-3	SDS	181,61	12,70	50,80	8,73	22,23	33,34	2,38	3,4	PHP 1-B68-SDS		
		167,6	6,6	177,8	7,0	C-3	SDS	186,69	12,70	50,80	8,73	22,23	33,34	2,38	3,5	PHP 1-B70-SDS		
		177,8	7,0	188,0	7,4	D-3	SDS	196,85	12,70	50,80	13,49	25,40	33,34	5,56	4,0	PHP 1-B74-SDS		
		193,0	7,6	203,2	8,0	D-3	SDS	212,09	12,70	50,80	13,49	25,40	33,34	5,56	4,4	PHP 1-B80-SDS		
		208,3	8,2	218,4	8,6	D-3	SDS	227,33	12,70	50,80	13,49	25,40	33,34	5,56	4,5	PHP 1-B86-SDS		
		228,6	9,0	238,8	9,4	D-3	SDS	247,65	12,70	50,80	13,49	25,40	33,34	5,56	4,8	PHP 1-B94-SDS		
		269,2	10,6	279,4	11,0	D-3	SDS	288,29	12,70	50,80	13,49	25,40	33,34	5,56	5,0	PHP 1-B110-SDS		
		304,8	12,0	315,0	12,4	D-3	SDS	323,85	12,70	50,80	13,49	25,40	33,34	5,56	5,4	PHP 1-B124-SDS		
		335,3	13,2	345,4	13,6	D-3	SDS	354,33	12,70	50,80	13,49	25,40	33,34	5,56	6,4	PHP 1-B136-SDS		
		381,0	15,0	391,2	15,4	C-3	SK	400,05	12,70	66,68	16,67	25,40	49,21	7,14	7,3	PHP 1-B154-SK		
		396,2	15,6	406,4	16,0	C-3	SK	415,29	12,70	66,68	16,67	25,40	49,21	7,14	7,5	PHP 1-B160-SK		
		457,2	18,0	467,4	18,4	C-3	SK	476,25	12,70	66,68	16,67	25,40	49,21	7,14	8,2	PHP 1-B184-SK		
		497,8	19,6	508,0	20,0	C-3	SK	516,89	12,70	66,68	16,67	25,40	49,21	7,14	9,1	PHP 1-B200-SK		
		A/B	2	76,2	3,0	86,4	3,4	E-1	SH	95,25	12,70	41,28	27,78	44,45	33,34	16,67	1,5	PHP 2-B34-SH
				81,3	3,2	91,4	3,6	D-1	SH	100,33	12,70	41,28	11,91	44,45	33,34	23,02	1,5	PHP 2-B36-SH
				86,4	3,4	96,5	3,8	D-1	SH	105,41	12,70	41,28	11,91	44,45	33,34	23,02	1,8	PHP 2-B38-SH
				91,4	3,6	101,6	4,0	A-1	SH	110,49	12,70	41,28	0,79	44,45	33,34	10,32	1,9	PHP 2-B40-SH
				96,5	3,8	106,7	4,2	A-1	SH	115,57	12,70	41,28	0,79	44,45	33,34	10,32	2,0	PHP 2-B42-SH
				101,6	4,0	111,8	4,4	A-1	SH	120,65	12,70	41,28	0,79	44,45	33,34	10,32	2,1	PHP 2-B44-SH
				106,7	4,2	116,8	4,6	A-1	SDS	125,73	12,70	50,80	0,79	44,45	33,34	10,32	2,3	PHP 2-B46-SDS
				111,8	4,4	121,9	4,8	A-1	SDS	130,81	12,70	50,80	0,79	44,45	33,34	10,32	2,5	PHP 2-B48-SDS
				116,8	4,6	127,0	5,0	A-1	SDS	135,89	12,70	50,80	0,79	44,45	33,34	10,32	2,7	PHP 2-B50-SDS
				121,9	4,8	132,1	5,2	A-1	SDS	140,97	12,70	50,80	0,79	44,45	33,34	10,32	2,9	PHP 2-B52-SDS
127,0	5,0			137,2	5,4	A-1	SDS	146,05	12,70	50,80	0,79	44,45	33,34	10,32	3,0	PHP 2-B54-SDS		
132,1	5,2			142,2	5,6	A-2	SDS	151,13	12,70	50,80	0,79	44,45	33,34	10,32	3,1	PHP 2-B56-SDS		
137,2	5,4			147,3	5,8	A-2	SDS	156,21	12,70	50,80	0,79	44,45	33,34	10,32	3,3	PHP 2-B58-SDS		
142,2	5,6			152,4	6,0	A-2	SDS	161,29	12,70	50,80	0,79	44,45	33,34	10,32	3,4	PHP 2-B60-SDS		
147,3	5,8			157,5	6,2	A-2	SDS	166,37	12,70	50,80	0,79	44,45	33,34	10,32	3,5	PHP 2-B62-SDS		
152,4	6,0			162,6	6,4	A-2	SDS	171,45	12,70	50,80	0,79	44,45	33,34	10,32	3,7	PHP 2-B64-SDS		
157,5	6,2			167,6	6,6	A-2	SDS	176,53	12,70	50,80	0,79	44,45	33,34	10,32	3,9	PHP 2-B66-SDS		
162,6	6,4			172,7	6,8	A-3	SDS	181,61	12,70	50,80	0,79	44,45	33,34	10,32	4,1	PHP 2-B68-SDS		
167,6	6,6			177,8	7,0	D-1	SK	186,69	12,70	66,68	8,73	44,45	49,21	3,97	4,2	PHP 2-B70-SK		
177,8	7,0			188,0	7,4	D-3	SK	196,85	12,70	66,68	8,73	44,45	49,21	3,97	4,8	PHP 2-B74-SK		
193,0	7,6			203,2	8,0	D-3	SK	212,09	12,70	66,68	8,73	44,45	49,21	3,97	5,0	PHP 2-B80-SK		
208,3	8,2			218,4	8,6	D-3	SK	227,33	12,70	66,68	8,73	44,45	49,21	3,97	5,3	PHP 2-B86-SK		
228,6	9,0			238,8	9,4	D-3	SK	247,65	12,70	66,68	8,73	44,45	49,21	3,97	5,9	PHP 2-B94-SK		
269,2	10,6			279,4	11,0	D-3	SK	288,29	12,70	66,68	8,73	44,45	49,21	3,97	6,4	PHP 2-B110-SK		

¹⁾ Please, note that 1 in pulley type stands for solid version, 2 for web version and 3 for arm/spoke version.

²⁾ Mass does not include bushings.

Classical V-belt pulleys

A/B QD bushed

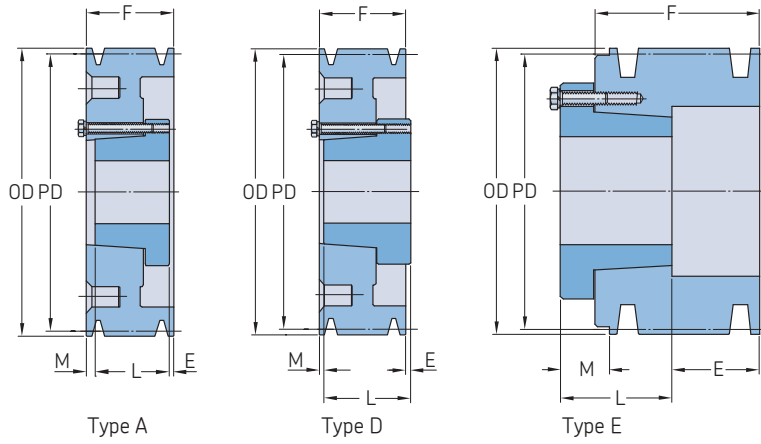

Section	Number of grooves	Pitch diameter Belt A		Belt B		Pulley type ¹⁾	Bushing number	Dimensions					Mass ²⁾	Designation		
		PD	PD	PD	PD			Outer diameter OD	Bore Min.	Max.	E	F			L	M
-	-	mm	in.	mm	in.	-	-	mm					kg	-		
A/B	4	751,8	29,6	762,0	30,0	D-3	E	770,89	22,23	88,90	3,97	82,55	69,85	16,67	39,0	PHP 4-B300-E
		955,0	37,6	965,2	38,0	D-3	E	974,09	22,23	88,90	3,97	82,55	69,85	16,67	49,4	PHP 4-B380-E
A/B	5	76,2	3,0	86,4	3,4	E-1	SD	95,25	12,70	50,80	81,76	101,60	46,04	26,19	2,8	PHP 5-B34-SD
		81,3	3,2	91,4	3,6	E-1	SD	100,33	12,70	50,80	81,76	101,60	46,04	26,19	3,0	PHP 5-B36-SD
		86,4	3,4	96,5	3,8	E-1	SD	105,41	12,70	50,80	81,76	101,60	46,04	26,19	3,2	PHP 5-B38-SD
		91,4	3,6	101,6	4,0	E-1	SD	110,49	12,70	50,80	72,23	101,60	46,04	16,67	3,4	PHP 5-B40-SD
		96,5	3,8	106,7	4,2	E-1	SD	115,57	12,70	50,80	72,23	101,60	46,04	16,67	3,6	PHP 5-B42-SD
		101,6	4,0	111,8	4,4	E-1	SD	120,65	12,70	50,80	72,23	101,60	46,04	16,67	3,9	PHP 5-B44-SD
		106,7	4,2	116,8	4,6	A-1	SD	125,73	12,70	50,80	67,47	101,60	46,04	38,89	4,1	PHP 5-B46-SD
		111,8	4,4	121,9	4,8	A-1	SD	130,81	12,70	50,80	67,47	101,60	46,04	38,89	4,3	PHP 5-B48-SD
		116,8	4,6	127,0	5,0	A-1	SD	135,89	12,70	50,80	67,47	101,60	46,04	38,89	4,5	PHP 5-B50-SD
		121,9	4,8	132,1	5,2	A-1	SD	140,97	12,70	50,80	67,47	101,60	46,04	38,89	4,7	PHP 5-B52-SD
		127,0	5,0	137,2	5,4	A-1	SK	146,05	12,70	66,68	13,49	101,60	49,21	38,89	4,9	PHP 5-B54-SK
		132,1	5,2	142,2	5,6	A-1	SK	151,13	12,70	66,68	13,49	101,60	49,21	38,89	5,1	PHP 5-B56-SK
		137,2	5,4	147,3	5,8	A-1	SK	156,21	12,70	66,68	13,49	101,60	49,21	38,89	5,4	PHP 5-B58-SK
		142,2	5,6	152,4	6,0	A-1	SK	161,29	12,70	66,68	13,49	101,60	49,21	38,89	6,4	PHP 5-B60-SK
		147,3	5,8	157,5	6,2	A-1	SK	166,37	12,70	66,68	13,49	101,60	49,21	38,89	6,8	PHP 5-B62-SK
		152,4	6,0	162,6	6,4	A-1	SK	171,45	12,70	66,68	13,49	101,60	49,21	38,89	7,3	PHP 5-B64-SK
		157,5	6,2	167,6	6,6	A-1	SK	176,53	12,70	66,68	13,49	101,60	49,21	38,89	7,7	PHP 5-B66-SK
		162,6	6,4	172,7	6,8	A-1	SK	181,61	12,70	66,68	13,49	101,60	49,21	38,89	8,2	PHP 5-B68-SK
		167,6	6,6	177,8	7,0	A-1	SF	186,69	12,70	74,61	11,91	101,60	52,39	37,31	8,6	PHP 5-B70-SF
		177,8	7,0	188,0	7,4	A-2	SF	196,85	12,70	74,61	11,91	101,60	52,39	37,31	9,1	PHP 5-B74-SF
		193,0	7,6	203,2	8,0	A-2	SF	212,09	12,70	74,61	11,91	101,60	52,39	37,31	9,5	PHP 5-B80-SF
		208,3	8,2	218,4	8,6	A-2	SF	227,33	12,70	74,61	11,91	101,60	52,39	37,31	10,0	PHP 5-B86-SF
		228,6	9,0	238,8	9,4	A-3	SF	247,65	12,70	74,61	11,91	101,60	52,39	37,31	10,9	PHP 5-B94-SF
		269,2	10,6	279,4	11,0	A-3	SF	288,29	12,70	74,61	11,91	101,60	52,39	37,31	13,2	PHP 5-B110-SF
		304,8	12,0	315,0	12,4	A-3	SF	323,85	12,70	74,61	11,91	101,60	52,39	37,31	15,4	PHP 5-B124-SF
		335,3	13,2	345,4	13,6	A-3	SF	354,33	12,70	74,61	11,91	101,60	52,39	37,31	17,2	PHP 5-B136-SF
		381,0	15,0	391,2	15,4	A-3	SF	400,05	12,70	74,61	11,91	101,60	52,39	37,31	20,9	PHP 5-B154-SF
		396,2	15,6	406,4	16,0	A-3	SF	415,29	12,70	74,61	11,91	101,60	52,39	37,31	22,2	PHP 5-B160-SF
		457,2	18,0	467,4	18,4	A-3	SF	476,25	12,70	74,61	11,91	101,60	52,39	37,31	25,0	PHP 5-B184-SF
		497,8	19,6	508,0	20,0	A-3	E	516,89	22,23	12,70	1,59	101,60	69,85	29,37	29,5	PHP 5-B200-E
		624,8	24,6	635,0	25,0	A-3	E	643,89	22,23	12,70	1,59	101,60	69,85	29,37	39,0	PHP 5-B250-E
		751,8	29,6	762,0	30,0	A-3	E	770,89	22,23	12,70	1,59	101,60	69,85	29,37	46,3	PHP 5-B300-E
955,0	37,6	965,2	38,0	A-3	E	974,09	22,23	12,70	1,59	101,60	69,85	29,37	59,9	PHP 5-B380-E		
A/B	6	76,2	3,0	86,4	3,4	E-1	SD	95,25	12,70	50,80	100,81	120,65	46,04	26,19	3,0	PHP 6-B34-SD
		81,3	3,2	91,4	3,6	E-1	SD	100,33	12,70	50,80	100,81	120,65	46,04	26,19	3,4	PHP 6-B36-SD
		86,4	3,4	96,5	3,8	E-1	SD	105,41	12,70	50,80	100,81	120,65	46,04	26,19	3,6	PHP 6-B38-SD
		91,4	3,6	101,6	4,0	E-1	SD	110,49	12,70	50,80	91,28	120,65	46,04	16,67	3,8	PHP 6-B40-SD
		96,5	3,8	106,7	4,2	E-1	SD	115,57	12,70	50,80	91,28	120,65	46,04	16,67	4,1	PHP 6-B42-SD
		101,6	4,0	111,8	4,4	E-1	SD	120,65	12,70	50,80	91,28	120,65	46,04	16,67	4,4	PHP 6-B44-SD
		106,7	4,2	116,8	4,6	A-1	SD	125,73	12,70	50,80	16,67	120,65	46,04	57,94	4,6	PHP 6-B46-SD
		111,8	4,4	121,9	4,8	A-1	SD	130,81	12,70	50,80	16,67	120,65	46,04	57,94	4,8	PHP 6-B48-SD
		116,8	4,6	127,0	5,0	A-1	SD	135,89	12,70	50,80	16,67	120,65	46,04	57,94	5,0	PHP 6-B50-SD
		121,9	4,8	132,1	5,2	A-1	SD	140,97	12,70	50,80	16,67	120,65	46,04	57,94	5,4	PHP 6-B52-SD
		127,0	5,0	137,2	5,4	A-1	SK	146,05	12,70	66,68	13,49	120,65	49,21	57,94	5,9	PHP 6-B54-SK
		132,1	5,2	142,2	5,6	A-1	SK	151,13	12,70	66,68	13,49	120,65	49,21	57,94	6,4	PHP 6-B56-SK
		137,2	5,4	147,3	5,8	A-1	SK	156,21	12,70	66,68	13,49	120,65	49,21	57,94	6,6	PHP 6-B58-SK
		142,2	5,6	152,4	6,0	A-1	SK	161,29	12,70	66,68	13,49	120,65	49,21	57,94	6,8	PHP 6-B60-SK
		147,3	5,8	157,5	6,2	A-1	SK	166,37	12,70	66,68	13,49	120,65	49,21	57,94	7,3	PHP 6-B62-SK
		152,4	6,0	162,6	6,4	A-1	SK	171,45	12,70	66,68	13,49	120,65	49,21	57,94	7,7	PHP 6-B64-SK
		157,5	6,2	167,6	6,6	A-1	SK	176,53	12,70	66,68	13,49	120,65	49,21	57,94	8,2	PHP 6-B66-SK
		162,6	6,4	172,7	6,8	A-1	SK	181,61	12,70	66,68	13,49	120,65	49,21	57,94	8,6	PHP 6-B68-SK

¹⁾ Please, note that 1 in pulley type stands for solid version, 2 for web version and 3 for arm/spoke version.
²⁾ Mass does not include bushings.

Classical V-belt pulleys

A/B QD bushed

Section	Number of grooves	Pitch diameter Belt A		Belt B		Pulley type ¹⁾	Bushing number	Dimensions				Mass ²⁾	Designation					
		PD		PD				Outer diameter OD	Bore Min.	Max.	E			F	L	M		
-	-	mm	in.	mm	in.	-	-	mm					kg	-				
A/B	6	167,6	6,6	177,8	7,0	A-1	SF	186,69	12,70	74,61	21,43	120,65	52,39	46,83	9,1	PHP 6-B70-SF		
		177,8	7,0	188,0	7,4	A-1	SF	196,85	12,70	74,61	21,43	120,65	52,39	46,83	10,0	PHP 6-B74-SF		
		193,0	7,6	203,2	8,0	A-2	SF	212,09	12,70	74,61	21,43	120,65	52,39	46,83	10,9	PHP 6-B80-SF		
		208,3	8,2	218,4	8,6	A-2	SF	227,33	12,70	74,61	21,43	120,65	52,39	46,83	11,8	PHP 6-B86-SF		
		228,6	9,0	238,8	9,4	A-3	SF	247,65	12,70	74,61	21,43	120,65	52,39	46,83	12,3	PHP 6-B94-SF		
		269,2	10,6	279,4	11,0	A-3	SF	288,29	12,70	74,61	21,43	120,65	52,39	46,83	14,5	PHP 6-B110-SF		
		304,8	12,0	315,0	12,4	A-3	SF	323,85	12,70	74,61	21,43	120,65	52,39	46,83	17,7	PHP 6-B124-SF		
		335,3	13,2	345,4	13,6	A-3	SF	354,33	12,70	74,61	21,43	120,65	52,39	46,83	20,0	PHP 6-B136-SF		
		381,0	15,0	391,2	15,4	A-3	SF	400,05	12,70	74,61	21,43	120,65	52,39	46,83	22,7	PHP 6-B154-SF		
		396,2	15,6	406,4	16,0	A-3	SF	415,29	12,70	74,61	21,43	120,65	52,39	46,83	24,5	PHP 6-B160-SF		
		457,2	18,0	467,4	18,4	A-3	SF	476,25	12,70	74,61	21,43	120,65	52,39	46,83	28,1	PHP 6-B184-SF		
		497,8	19,6	508,0	20,0	A-3	E	516,89	22,23	88,90	5,56	120,65	69,85	45,24	33,6	PHP 6-B200-E		
		624,8	24,6	635,0	25,0	A-3	E	643,89	22,23	88,90	5,56	120,65	69,85	45,24	43,5	PHP 6-B250-E		
		751,8	29,6	762,0	30,0	A-3	E	770,89	22,23	88,90	5,56	120,65	69,85	45,24	54,0	PHP 6-B300-E		
		955,0	37,6	965,2	38,0	A-3	E	974,09	22,23	88,90	5,56	120,65	69,85	45,24	60,8	PHP 6-B380-E		
		A/B	8	127,0	5,0	137,2	5,4	A-1	SK	146,05	12,70	66,68	26,19	158,75	49,21	83,34	6,8	PHP 8-B54-SK
				132,1	5,2	142,2	5,6	A-1	SK	151,13	12,70	66,68	26,19	158,75	49,21	83,34	7,3	PHP 8-B56-SK
				142,2	5,6	152,4	6,0	A-1	SF	161,29	12,70	74,61	24,61	158,75	52,39	81,76	9,1	PHP 8-B60-SF
				152,4	6,0	162,6	6,4	A-1	SF	171,45	12,70	74,61	24,61	158,75	52,39	81,76	10,4	PHP 8-B64-SF
				162,6	6,4	172,7	6,8	A-1	SF	181,61	12,70	74,61	24,61	158,75	52,39	81,76	11,3	PHP 8-B68-SF
177,8	7,0			188,0	7,4	A-1	SF	196,85	12,70	74,61	24,61	158,75	52,39	81,76	12,7	PHP 8-B74-SF		
208,3	8,2			218,4	8,6	A-1	E	227,33	22,23	88,90	30,96	158,75	69,85	57,94	18,1	PHP 8-B86-E		
228,6	9,0			238,8	9,4	A-2	E	247,65	22,23	88,90	30,96	158,75	69,85	57,94	19,5	PHP 8-B94-E		
269,2	10,6			279,4	11,0	A-3	E	288,29	22,23	88,90	30,96	158,75	69,85	57,94	22,2	PHP 8-B110-E		
304,8	12,0			315,0	12,4	A-3	E	323,85	22,23	88,90	30,96	158,75	69,85	57,94	25,4	PHP 8-B124-E		
381,0	15,0			391,2	15,4	A-3	E	400,05	22,23	88,90	30,96	158,75	69,85	57,94	31,3	PHP 8-B154-E		
457,2	18,0			467,4	18,4	D-3	F	476,25	25,40	101,60	0,79	158,75	95,25	64,29	41,3	PHP 8-B184-F		
497,8	19,6			508,0	20,0	D-3	F	516,89	25,40	101,60	0,79	158,75	95,25	64,29	44,5	PHP 8-B200-F		
624,8	24,6			635,0	25,0	D-3	F	643,89	25,40	101,60	0,79	158,75	95,25	64,29	54,9	PHP 8-B250-F		
751,8	29,6			762,0	30,0	D-3	F	770,89	25,40	101,60	0,79	158,75	95,25	64,29	67,1	PHP 8-B300-F		
955,0	37,6			965,2	38,0	D-3	F	974,09	25,40	101,60	0,79	158,75	95,25	64,29	88,0	PHP 8-B380-F		
A/B	10			127,0	5,0	137,2	5,4	A-1	SK	146,05	12,70	66,68	45,24	196,85	49,21	102,39	8,2	PHP 10-B54-SK
				132,1	5,2	142,2	5,6	A-1	SK	151,13	12,70	66,68	45,24	196,85	49,21	102,39	9,1	PHP 10-B56-SK
				142,2	5,6	152,4	6,0	A-1	SF	161,29	12,70	74,61	42,86	196,85	52,39	100,81	10,9	PHP 10-B60-SF
				152,4	6,0	162,6	6,4	A-1	SF	171,45	12,70	74,61	42,86	196,85	52,39	100,81	11,8	PHP 10-B64-SF
		162,6	6,4	172,7	6,8	A-1	SF	181,61	12,70	74,61	42,86	196,85	52,39	100,81	12,7	PHP 10-B68-SF		
		177,8	7,0	188,0	7,4	A-1	SF	196,85	12,70	74,61	42,86	196,85	52,39	100,81	14,5	PHP 10-B74-SF		
		208,3	8,2	218,4	8,6	A-1	E	227,33	22,23	88,90	50,01	196,85	69,85	76,99	19,1	PHP 10-B86-E		
		228,6	9,0	238,8	9,4	A-2	E	247,65	22,23	88,90	50,01	196,85	69,85	76,99	21,8	PHP 10-B94-E		
		269,2	10,6	279,4	11,0	A-3	E	288,29	22,23	88,90	50,01	196,85	69,85	76,99	25,4	PHP 10-B110-E		
		304,8	12,0	315,0	12,4	A-3	E	323,85	22,23	88,90	50,01	196,85	69,85	76,99	29,0	PHP 10-B124-E		
		381,0	15,0	391,2	15,4	A-3	F	400,05	25,40	101,60	15,88	196,85	95,25	83,34	39,9	PHP 10-B154-F		
		457,2	18,0	467,4	18,4	A-3	F	476,25	25,40	101,60	15,88	196,85	95,25	83,34	46,7	PHP 10-B184-F		
		497,8	19,6	508,0	20,0	A-3	F	516,89	25,40	101,60	15,88	196,85	95,25	83,34	50,8	PHP 10-B200-F		
		624,8	24,6	635,0	25,0	A-3	F	643,89	25,40	101,60	15,88	196,85	95,25	83,34	64,4	PHP 10-B250-F		
		751,8	29,6	762,0	30,0	A-3	F	770,89	25,40	101,60	15,88	196,85	95,25	83,34	78,9	PHP 10-B300-F		
		955,0	37,6	965,2	38,0	A-3	J	974,09	38,10	114,30	3,18	196,85	117,48	76,20	104,3	PHP 10-B380-J		

¹⁾ Please, note that 1 in pulley type stands for solid version, 2 for web version and 3 for arm/spoke version.

²⁾ Mass does not include bushings.

Classical V-belt pulleys

C QD bushed

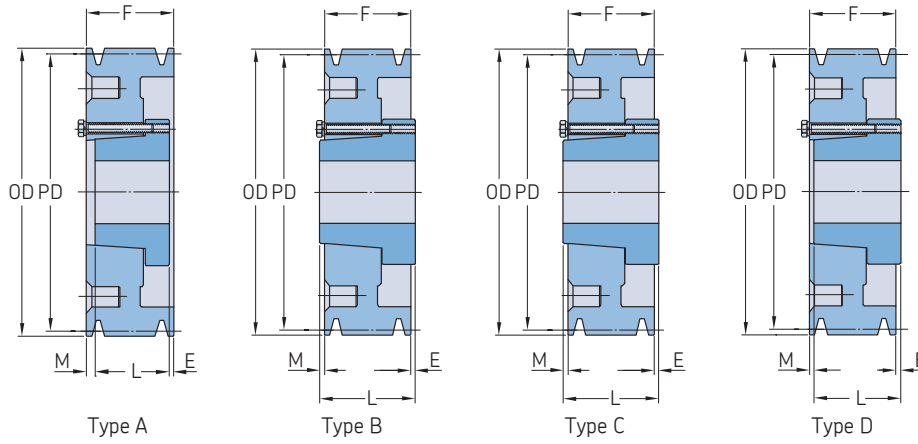

Section	Number of grooves	Pitch diameter		Pulley type ¹⁾	Bushing number	Dimensions						Mass ²⁾	Designation			
		PD				Outer diameter OD	Bore Min.	Max.	E	F	L			M		
		mm	in.												kg	
C	1	177,8	7,0	D-1	SF	187,96	12,70	74,61	21,43	31,75	52,39	1	4,5	PHP 1-C70-SF		
		190,5	7,5	D-2	SF	200,66	12,70	74,61	21,43	31,75	52,39	1	5,4	PHP 1-C75-SF		
		203,2	8,0	D-2	SF	213,36	12,70	74,61	21,43	31,75	52,39	1	5,9	PHP 1-C80-SF		
		215,9	8,5	D-2	SF	226,06	12,70	74,61	21,43	31,75	52,39	1	6,4	PHP 1-C85-SF		
		228,6	9,0	D-3	SF	238,76	12,70	74,61	21,43	31,75	52,39	1	6,8	PHP 1-C90-SF		
		241,3	9,5	D-3	SF	251,46	12,70	74,61	21,43	31,75	52,39	1	7,3	PHP 1-C95-SF		
		254,0	10,0	D-3	SF	264,16	12,70	74,61	21,43	31,75	52,39	1	7,7	PHP 1-C100-SF		
		266,7	10,5	D-3	SF	276,86	12,70	74,61	21,43	31,75	52,39	1	8,2	PHP 1-C105-SF		
		279,4	11,0	D-3	SF	289,56	12,70	74,61	21,43	31,75	52,39	1	8,6	PHP 1-C110-SF		
		304,8	12,0	D-3	SF	314,96	12,70	74,61	21,43	31,75	52,39	1	9,1	PHP 1-C120-SF		
	330,2	13,0	D-3	SF	340,36	12,70	74,61	21,43	31,75	52,39	1	10,0	PHP 1-C130-SF			
	355,6	14,0	D-3	SF	365,76	12,70	74,61	21,43	31,75	52,39	1	10,9	PHP 1-C140-SF			
	406,4	16,0	D-3	SF	416,56	12,70	74,61	21,43	31,75	52,39	1	11,8	PHP 1-C160-SF			
	457,2	18,0	D-3	SF	467,36	12,70	74,61	21,43	31,75	52,39	1	13,6	PHP 1-C180-SF			
	508,0	20,0	D-3	SF	518,16	12,70	74,61	21,43	31,75	52,39	1	15,9	PHP 1-C200-SF			
	609,6	24,0	D-3	SF	619,76	12,70	74,61	21,43	31,75	52,39	1	18,6	PHP 1-C240-SF			
	C	2	177,8	7,0	D-1	SF	187,96	12,70	74,61	2,38	57,15	52,39	7	6,8	PHP 2-C70-SF	
			190,5	7,5	D-1	SF	200,66	12,70	74,61	2,38	57,15	52,39	7	7,7	PHP 2-C75-SF	
			203,2	8,0	D-1	SF	213,36	12,70	74,61	2,38	57,15	52,39	7	8,2	PHP 2-C80-SF	
			215,9	8,5	D-2	SF	226,06	12,70	74,61	2,38	57,15	52,39	7	8,6	PHP 2-C85-SF	
228,6			9,0	D-2	SF	238,76	12,70	74,61	2,38	57,15	52,39	7	9,1	PHP 2-C90-SF		
241,3			9,5	D-2	SF	251,46	12,70	74,61	2,38	57,15	52,39	7	9,5	PHP 2-C95-SF		
254,0			10,0	D-3	SF	264,16	12,70	74,61	2,38	57,15	52,39	7	10,0	PHP 2-C100-SF		
266,7			10,5	D-3	SF	276,86	12,70	74,61	2,38	57,15	52,39	7	10,4	PHP 2-C105-SF		
279,4			11,0	D-3	SF	289,56	12,70	74,61	2,38	57,15	52,39	7	10,9	PHP 2-C110-SF		
304,8			12,0	D-3	SF	314,96	12,70	74,61	8,73	57,15	52,39	13	11,3	PHP 2-C120-SF		
330,2		13,0	D-3	SF	340,36	12,70	74,61	8,73	57,15	52,39	13	12,7	PHP 2-C130-SF			
355,6		14,0	D-3	SF	365,76	12,70	74,61	8,73	57,15	52,39	13	14,1	PHP 2-C140-SF			
406,4		16,0	D-3	SF	416,56	12,70	74,61	8,73	57,15	52,39	13	16,3	PHP 2-C160-SF			
457,2		18,0	D-3	SF	467,36	12,70	74,61	8,73	57,15	52,39	13	17,7	PHP 2-C180-SF			
508,0		20,0	D-3	SF	518,16	12,70	74,61	8,73	57,15	52,39	13	21,8	PHP 2-C200-SF			
609,6	24,0	D-3	SF	619,76	12,70	74,61	8,73	57,15	52,39	13	27,2	PHP 2-C240-SF				
762,0	30,0	C-3	F	772,16	25,40	101,60	30,96	57,15	95,25	7	38,6	PHP 2-C300-F				
C	3	127,0	5,0	A-1	SD	137,16	12,70	50,80	15,08	82,55	46,04	21	4,5	PHP 3-C50-SD		
		139,7	5,5	A-1	SD	149,86	12,70	50,80	15,08	82,55	46,04	21	5,4	PHP 3-C55-SD		
		152,4	6,0	D-1	SF	162,56	12,70	74,61	18,26	82,55	52,39	48	6,8	PHP 3-C60-SF		
		177,8	7,0	A-1	SF	187,96	12,70	74,61	10,32	82,55	52,39	20	8,2	PHP 3-C70-SF		
		190,5	7,5	A-1	SF	200,66	12,70	74,61	10,32	82,55	52,39	20	9,1	PHP 3-C75-SF		
		203,2	8,0	B-1	E	213,36	22,23	88,90	13,49	82,55	69,85	1	11,8	PHP 3-C80-E		
		215,9	8,5	B-1	E	226,06	22,23	88,90	13,49	82,55	69,85	1	13,2	PHP 3-C85-E		
		228,6	9,0	A-1	E	238,76	22,23	88,90	11,91	82,55	69,85	1	14,5	PHP 3-C90-E		
		241,3	9,5	A-2	E	251,46	22,23	88,90	11,91	82,55	69,85	1	15,4	PHP 3-C95-E		
		254,0	10,0	A-2	E	264,16	22,23	88,90	11,91	82,55	69,85	1	16,3	PHP 3-C100-E		
	266,7	10,5	A-3	E	276,86	22,23	88,90	11,91	82,55	69,85	1	17,2	PHP 3-C105-E			
	279,4	11,0	A-3	E	289,56	22,23	88,90	11,91	82,55	69,85	1	18,1	PHP 3-C110-E			
	304,8	12,0	A-3	E	314,96	22,23	88,90	11,91	82,55	69,85	1	19,5	PHP 3-C120-E			
	330,2	13,0	A-3	E	340,36	22,23	88,90	11,91	82,55	69,85	1	20,4	PHP 3-C130-E			
	355,6	14,0	A-3	E	365,76	22,23	88,90	11,91	82,55	69,85	1	23,1	PHP 3-C140-E			
	406,4	16,0	A-3	E	416,56	22,23	88,90	11,91	82,55	69,85	1	26,8	PHP 3-C160-E			
	457,2	18,0	A-3	E	467,36	22,23	88,90	11,91	82,55	69,85	1	29,5	PHP 3-C180-E			
	508,0	20,0	D-3	E	518,16	22,23	88,90	5,56	82,55	69,85	18	31,8	PHP 3-C200-E			
	609,6	24,0	D-3	E	619,76	22,23	88,90	5,56	82,55	69,85	18	36,3	PHP 3-C240-E			
	685,8	27,0	D-3	F	695,96	25,40	101,60	16,67	82,55	95,25	4	47,6	PHP 3-C270-F			

¹⁾ Please, note that 1 in pulley type stands for solid version, 2 for web version and 3 for arm/spoke version.

²⁾ Mass does not include bushings.

Classical V-belt pulleys

C QD bushed

Section	Number of grooves	Pitch diameter		Pulley type ¹⁾	Bushing number	Dimensions						Mass ²⁾	Designation	
		PD				Outer diameter OD	Bore Min.	Max.	E	F	L			M
		mm	in.											
C	3	762,0 914,4 1117,6 1270,0	30,0 36,0 44,0 50,0	D-3 D-3 D-3 D-3	F F F F	772,16 924,56 1127,76 1280,16	25,40 25,40 25,40 25,40	101,60 101,60 101,60 101,60	16,67 16,67 16,67 16,67	82,55 82,55 82,55 82,55	95,25 95,25 95,25 95,25	4 4 4 4	54,4 63,5 77,1 86,2	PHP 3-C300-F PHP 3-C360-F PHP 3-C440-F PHP 3-C500-F
C	4	127,0 139,7 152,4 177,8 190,5 203,2 215,9 228,6 241,3 254,0 266,7 279,4 304,8 330,2 355,6 406,4 457,2 508,0 609,6 685,8 762,0 914,4 1117,6 1270,0	5,0 5,5 6,0 7,0 7,5 8,0 8,5 9,0 9,5 10,0 10,5 11,0 12,0 13,0 14,0 16,0 18,0 20,0 24,0 27,0 30,0 36,0 44,0 50,0	A-1 A-1 A-1 A-1 A-1 A-1 A-1 A-1 A-2 A-2 A-2 A-2 A-3 A-3 A-3 A-3 A-3 A-3 D-3 D-3 D-3 D-3 C-3 C-3	SD SD SF SF SF E E E E E E E E F F F F J J	137,16 149,86 162,56 187,96 200,66 213,36 226,06 238,76 251,46 264,16 276,86 289,56 314,96 340,36 365,76 416,56 467,36 518,16 619,76 695,96 772,16 924,56 1127,76 1280,16	12,70 12,70 12,70 12,70 12,70 22,23 22,23 22,23 22,23 22,23 22,23 22,23 22,23 25,40 25,40 38,10 38,10	50,80 50,80 74,61 74,61 74,61 88,90 88,90 88,90 88,90 88,90 101,60 101,60 114,30 114,30	21,43 21,43 16,67 16,67 16,67 19,84 19,84 19,84 19,84 19,84 2,38 2,38 - -	107,95 107,95 107,95 107,95 107,95 107,95 107,95 107,95 107,95 107,95 107,95 107,95 107,95 107,95 107,95 107,95 107,95 107,95 2,38 2,38 107,95 107,95	46,04 46,04 52,39 52,39 52,39 69,85 69,85 69,85 69,85 69,85 69,85 69,85 69,85 95,25 95,25 95,25 117,48 117,48	40 40 39 39 39 18 18 18 18 18 18 18 18 15 15 15 15 10 10	5,4 6,4 7,7 9,5 11,3 13,6 15,0 15,9 17,2 18,1 19,5 20,9 22,7 24,5 26,8 29,5 33,1 37,2 47,6 56,7 64,4 78,0 102,1 117,9	PHP 4-C50-SD PHP 4-C55-SD PHP 4-C60-SF PHP 4-C70-SF PHP 4-C75-SF PHP 4-C80-E PHP 4-C85-E PHP 4-C90-E PHP 4-C95-E PHP 4-C100-E PHP 4-C105-E PHP 4-C110-E PHP 4-C120-E PHP 4-C130-E PHP 4-C140-E PHP 4-C160-E PHP 4-C180-E PHP 4-C200-E PHP 4-C240-F PHP 4-C270-F PHP 4-C300-F PHP 4-C360-F PHP 4-C440-J PHP 4-C500-J
C	5	152,4 177,8 190,5 203,2 215,9 228,6 241,3 254,0 266,7 279,4 304,8 330,2 355,6 406,4 457,2 508,0 609,6 685,8 762,0 914,4 1117,6 1270,0	6,0 7,0 7,5 8,0 8,5 9,0 9,5 10,0 10,5 11,0 12,0 13,0 14,0 16,0 18,0 20,0 24,0 27,0 30,0 36,0 44,0 50,0	A-1 A-1 A-1 A-1 A-1 A-1 A-2 A-2 A-2 A-2 A-2 A-3 A-3 A-3 A-3 D-3 D-3 D-3 D-3 A-3 A-3 A-3	SF SF SF E E E E E E E E E E E E F F F F J J J	162,56 187,96 200,66 213,36 226,06 238,76 251,46 264,16 276,86 289,56 314,96 340,36 365,76 416,56 467,36 518,16 619,76 695,96 772,16 924,56 1127,76 1280,16	12,70 12,70 12,70 12,70 12,70 22,23 22,23 22,23 22,23 22,23 22,23 22,23 22,23 22,23 22,23 25,40 25,40 25,40 25,40 38,10 38,10 38,10	74,61 74,61 74,61 74,61 74,61 88,90 88,90 88,90 88,90 88,90 88,90 88,90 88,90 88,90 88,90 101,60 101,60 101,60 101,60 114,30 114,30 114,30	26,19 26,19 26,19 29,37 29,37 29,37 29,37 29,37 29,37 29,37 29,37 29,37 29,37 29,37 29,37 2,38 2,38 2,38 2,38 1,59 1,59 1,59	133,35 133,35 133,35 133,35 133,35 133,35 133,35 133,35 133,35 133,35 133,35 133,35 133,35 133,35 133,35 133,35 133,35 133,35 133,35 133,35 133,35 133,35	52,39 52,39 52,39 69,85 69,85 69,85 69,85 69,85 69,85 69,85 69,85 69,85 69,85 69,85 69,85 95,25 95,25 95,25 95,25 95,25 117,48 117,48	55 55 55 34 34 34 34 34 34 34 34 34 34 34 34 40 40 40 40 40 14 14	9,5 11,8 12,7 15,0 16,8 18,1 19,1 20,4 21,3 22,7 24,0 26,3 29,0 33,1 38,6 44,5 54,0 69,4 78,9 93,4 115,2 124,3	PHP 5-C60-SF PHP 5-C70-SF PHP 5-C75-SF PHP 5-C80-E PHP 5-C85-E PHP 5-C90-E PHP 5-C95-E PHP 5-C100-E PHP 5-C105-E PHP 5-C110-E PHP 5-C120-E PHP 5-C130-E PHP 5-C140-E PHP 5-C160-E PHP 5-C180-E PHP 5-C200-F PHP 5-C240-F PHP 5-C270-F PHP 5-C300-F PHP 5-C360-J PHP 5-C440-J PHP 5-C500-J
C	6	152,4 177,8 190,5 203,2 215,9 228,6 241,3 254,0 266,7 279,4 304,8 330,2 355,6 406,4 457,2 508,0 609,6 685,8 762,0 914,4 1117,6 1270,0	6,0 7,0 7,5 8,0 8,5 9,0 9,5 10,0 10,5 11,0 12,0 13,0 14,0 16,0 18,0 20,0 24,0 27,0 30,0 36,0 44,0 50,0	A-1 A-1 A-1 A-1 A-1 A-1 A-1 A-1 A-2 A-2 A-2 A-3 A-3 A-3 A-3 A-3 A-3 A-3 A-3 A-3 A-3 A-3	SF SF SF E E F F F F F F F F F F F F F F F J J	162,56 187,96 200,66 213,36 226,06 238,76 251,46 264,16 276,86 289,56 314,96 340,36 365,76 416,56 467,36 518,16 619,76 695,96 772,16 924,56 1127,76 1280,16	12,70 12,70 12,70 12,70 12,70 25,40 25,40 25,40 25,40 25,40 25,40 25,40 25,40 25,40 25,40 25,40 25,40 25,40 25,40 25,40 38,10 38,10	74,61 74,61 74,61 74,61 74,61 101,60 101,60 101,60 101,60 101,60 101,60 101,60 101,60 101,60 101,60 101,60 101,60 101,60 101,60 101,60 114,30 114,30	26,19 26,19 26,19 29,37 29,37 26,19 26,19 26,19 26,19 26,19 26,19 26,19 26,19 26,19 26,19 13,49 13,49 1,59 1,59 1,59 1,59 1,59	158,75 158,75 158,75 158,75 158,75 158,75 158,75 158,75 158,75 158,75 158,75 158,75 158,75 158,75 158,75 158,75 158,75 158,75 158,75 158,75 158,75 158,75	52,39 52,39 52,39 69,85 69,85 95,25 95,25 95,25 95,25 95,25 95,25 95,25 95,25 95,25 95,25 95,25 95,25 95,25 95,25 95,25 117,48 117,48	80 80 80 60 60 37 37 37 37 37 37 37 37 37 37 50 50 40 40 40 40 40	9,1 11,8 13,2 16,3 17,7 23,1 25,0 26,8 28,1 29,9 31,8 33,6 36,3 40,4 46,3 50,8 59,4 72,6 86,2 105,2 135,6 145,2	PHP 6-C60-SF PHP 6-C70-SF PHP 6-C75-SF PHP 6-C80-E PHP 6-C85-E PHP 6-C90-F PHP 6-C95-F PHP 6-C100-F PHP 6-C105-F PHP 6-C110-F PHP 6-C120-F PHP 6-C130-F PHP 6-C140-F PHP 6-C160-F PHP 6-C180-F PHP 6-C200-F PHP 6-C240-F PHP 6-C270-J PHP 6-C300-J PHP 6-C360-J PHP 6-C440-J PHP 6-C500-M

¹⁾ Please, note that 1 in pulley type stands for solid version, 2 for web version and 3 for arm/spoke version.

²⁾ Mass does not include bushings.

Classical V-belt pulleys
C QD bushed | D QD bushed

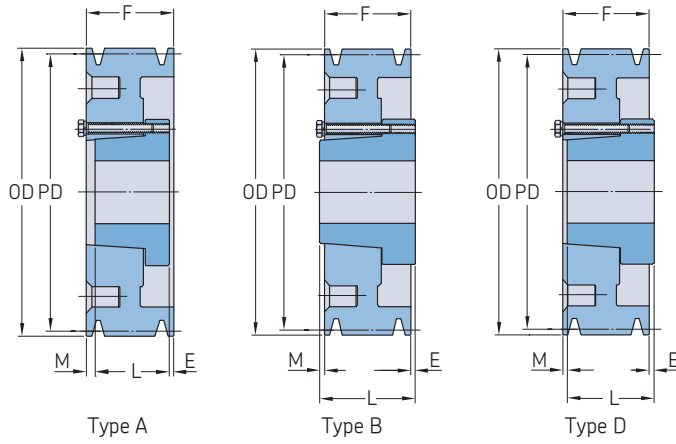

Section	Number of grooves	Pitch diameter		Pulley type ¹⁾	Bushing number	Dimensions						Mass ²⁾	Designation	
		PD	PD			Outer diameter OD	Bore Min.	Max.	E	F	L			M
-	-	mm	in.	-	-	mm							kg	-
C	8	203,2	8,0	A-1	E	213,36	22,23	88,90	51,59	209,55	69,85	88	19,5	PHP 8-C80-E
		215,9	8,5	A-1	E	226,06	22,23	88,90	76,99	209,55	69,85	88	21,8	PHP 8-C85-E
		228,6	9,0	A-1	F	238,76	25,40	101,60	48,42	209,55	95,25	66	27,2	PHP 8-C90-F
		241,3	9,5	A-1	F	251,46	25,40	101,60	48,42	209,55	95,25	66	29,5	PHP 8-C95-F
		254,0	10,0	A-1	F	264,16	25,40	101,60	48,42	209,55	95,25	66	31,3	PHP 8-C100-F
		266,7	10,5	A-2	F	276,86	25,40	101,60	48,42	209,55	95,25	66	33,1	PHP 8-C105-F
		279,4	11,0	A-2	F	289,56	25,40	101,60	48,42	209,55	95,25	66	35,4	PHP 8-C110-F
		304,8	12,0	A-3	F	314,96	25,40	101,60	48,42	209,55	95,25	66	37,7	PHP 8-C120-F
		330,2	13,0	A-3	F	340,36	25,40	101,60	48,42	209,55	95,25	66	40,4	PHP 8-C130-F
		355,6	14,0	A-3	F	365,76	25,40	101,60	48,42	209,55	95,25	66	44,0	PHP 8-C140-F
	406,4	16,0	A-3	F	416,56	25,40	101,60	48,42	209,55	95,25	66	51,3	PHP 8-C160-F	
	457,2	18,0	A-3	F	467,36	25,40	101,60	48,42	209,55	95,25	66	59,4	PHP 8-C180-F	
	508,0	20,0	A-3	J	518,16	38,10	114,30	1,59	209,55	117,48	90	69,0	PHP 8-C200-J	
	609,6	24,0	A-3	J	619,76	38,10	114,30	1,59	209,55	117,48	90	83,9	PHP 8-C240-J	
	685,8	27,0	A-3	J	695,96	38,10	114,30	1,59	209,55	117,48	90	94,4	PHP 8-C270-J	
	762,0	30,0	A-3	J	772,16	38,10	114,30	1,59	209,55	117,48	90	104,3	PHP 8-C300-J	
	914,4	36,0	A-3	M	924,56	50,80	139,70	7,14	209,55	171,45	31	138,8	PHP 8-C360-M	
	1117,6	44,0	A-3	M	1127,76	50,80	139,70	7,14	209,55	171,45	31	181,4	PHP 8-C440-M	
	1270,0	50,0	A-3	M	1280,16	50,80	139,70	7,14	209,55	171,45	31	215,5	PHP 8-C500-M	
	D	3	304,8	12,0	A-2	F	321,06	25,40	101,60	3,97	117,48	95,25	18	31,8
330,2			13,0	A-2	F	346,46	25,40	101,60	3,97	117,48	95,25	18	34,5	PHP 3-D130-F
342,9			13,5	A-2	F	359,16	25,40	101,60	3,97	117,48	95,25	18	35,8	PHP 3-D135-F
355,6			14,0	A-2	F	371,86	25,40	101,60	3,97	117,48	95,25	18	37,2	PHP 3-D140-F
368,3			14,5	A-3	F	384,56	25,40	101,60	3,97	117,48	95,25	18	38,6	PHP 3-D145-F
381,0		15,0	A-3	F	397,26	25,40	101,60	3,97	117,48	95,25	18	40,4	PHP 3-D150-F	
393,7		15,5	A-3	F	409,96	25,40	101,60	3,97	117,48	95,25	18	41,7	PHP 3-D155-F	
406,4		16,0	A-3	F	422,66	25,40	101,60	3,97	117,48	95,25	18	43,5	PHP 3-D160-F	
457,2		18,0	D-3	J	473,46	38,10	114,30	6,35	117,48	117,48	6	49,9	PHP 3-D180-J	
508,0		20,0	D-3	J	524,26	38,10	114,30	6,35	117,48	117,48	6	54,4	PHP 3-D200-J	
558,8		22,0	D-3	J	575,06	38,10	114,30	6,35	117,48	117,48	6	59,0	PHP 3-D220-J	
685,8		27,0	D-3	J	702,06	38,10	114,30	6,35	117,48	117,48	6	78,5	PHP 3-D270-J	
838,2		33,0	D-3	J	854,46	38,10	114,30	6,35	117,48	117,48	6	108,9	PHP 3-D330-J	
1016,0		40,0	D-3	J	1032,26	38,10	114,30	6,35	117,48	117,48	6	136,1	PHP 3-D440-J	
D		4	304,8	12,0	A-2	F	321,06	25,40	101,60	24,61	153,99	95,25	34	37,7
	330,2		13,0	A-2	F	346,46	25,40	101,60	24,61	153,99	95,25	34	39,0	PHP 4-D130-F
	342,9		13,5	A-2	F	359,16	25,40	101,60	24,61	153,99	95,25	34	40,4	PHP 4-D135-F
	355,6		14,0	A-2	F	371,86	25,40	101,60	24,61	153,99	95,25	34	41,7	PHP 4-D140-F
	368,3		14,5	A-3	F	384,56	25,40	101,60	24,61	153,99	95,25	34	43,1	PHP 4-D145-F
	381,0	15,0	A-3	F	397,26	25,40	101,60	24,61	153,99	95,25	34	44,9	PHP 4-D150-F	
	393,7	15,5	A-3	F	409,96	25,40	101,60	24,61	153,99	95,25	34	46,3	PHP 4-D155-F	
	406,4	16,0	A-3	F	422,66	25,40	101,60	24,61	153,99	95,25	34	48,1	PHP 4-D160-F	
	457,2	18,0	A-3	J	473,46	38,10	114,30	3,18	153,99	117,48	33	54,4	PHP 4-D180-J	
	508,0	20,0	A-3	J	524,26	38,10	114,30	3,18	153,99	117,48	33	59,9	PHP 4-D200-J	
	558,8	22,0	A-3	J	575,06	38,10	114,30	3,18	153,99	117,48	33	70,3	PHP 4-D220-J	
	685,8	27,0	A-3	J	702,06	38,10	114,30	3,18	153,99	117,48	33	87,5	PHP 4-D270-J	
	838,2	33,0	B-3	M	854,46	50,80	139,70	8,73	153,99	171,45	26	127,0	PHP 4-D330-M	
	1016,0	40,0	B-3	M	1032,26	50,80	139,70	8,73	153,99	171,45	26	157,9	PHP 4-D440-M	
	1219,2	48,0	B-3	M	1235,46	50,80	139,70	8,73	153,99	171,45	26	172,4	PHP 4-D480-M	
1473,2	58,0	B-3	M	1489,46	50,80	139,70	8,73	153,99	171,45	26	190,5	PHP 4-D580-M		
D	5	304,8	12,0	A-2	F	321,06	25,40	101,60	43,66	190,50	95,25	52	42,2	PHP 5-D120-F
		330,2	13,0	A-2	F	346,46	25,40	101,60	43,66	190,50	95,25	52	43,5	PHP 5-D130-F
		342,9	13,5	A-2	F	359,16	25,40	101,60	43,66	190,50	95,25	52	46,3	PHP 5-D135-F
		355,6	14,0	A-2	F	371,86	25,40	101,60	43,66	190,50	95,25	52	48,1	PHP 5-D140-F

¹⁾ Please, note that 1 in pulley type stands for solid version, 2 for web version and 3 for arm/spoke version.
²⁾ Mass does not include bushings.

Classical V-belt pulleys

D QD bushed

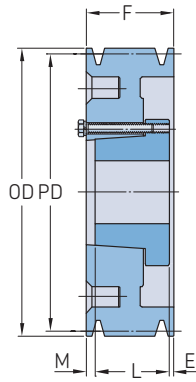

Type A

Section	Number of grooves	Pitch diameter PD		Pulley type ¹⁾	Bushing number	Dimensions				Mass ²⁾	Designation			
		mm	in.			Outer diameter OD	Bore Min.	Max.	E			F	L	M
-	-	mm	in.	-	-	mm						kg	-	
D	12	685,8	27,0	A-3	N	702,06	61,91	149,23	55,56	446,09	206,38	184	235,9	PHP 12-D270-N
		838,2	33,0	A-3	N	854,46	61,91	149,23	58,74	446,09	206,38	184	301,6	PHP 12-D330-N
		1016,0	40,0	A-3	P	1032,26	74,61	177,80	6,35	446,09	238,13	202	394,6	PHP 12-D400-P
		1219,2	48,0	A-3	P	1235,46	74,61	177,80	6,35	446,09	238,13	202	494,4	PHP 12-D480-P
		1473,2	58,0	A-3	P	1489,46	74,61	177,80	6,35	446,09	238,13	202	589,7	PHP 12-D580-P

¹⁾ Please, note that 1 in pulley type stands for solid version, 2 for web version and 3 for arm/spoke version.

²⁾ Mass does not include bushings.

Narrow wedge belt pulleys

3V taper bushed

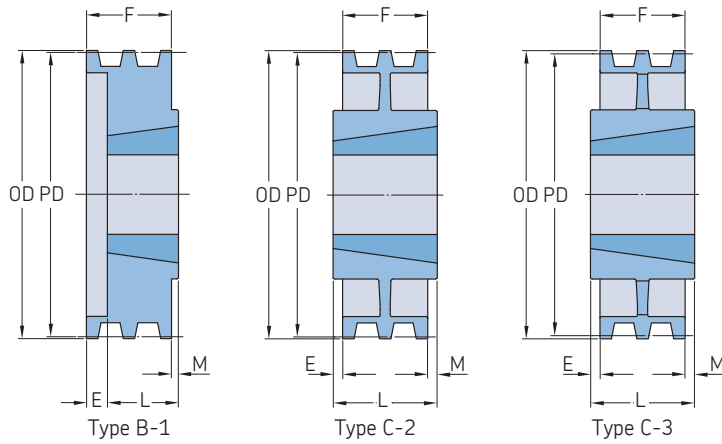

Section	Number of grooves	Pitch diameter PD	Pulley type	Bushing number	Dimensions		B Min.	Max.	F	E	L	M	Mass ²⁾	Designation
					Outer diameter OD	in.								
		mm			mm	in.							kg	
3V	1	66,04	B-1	1108	67,31	2,65	9,53	28,58	26,99	5,56	22,23	27,78	0,34	PHP 1-3V265TB
		69,85	B-1	1108	71,12	2,80	9,53	28,58	26,99	5,56	22,23	27,78	0,39	PHP 1-3V280TB
		74,93	B-1	1108	76,20	3,00	9,53	28,58	26,99	5,56	22,23	27,78	0,45	PHP 1-3V300TB
		78,74	B-1	1108	80,01	3,15	9,53	28,58	26,99	5,56	22,23	27,78	0,45	PHP 1-3V315TB
		83,82	B-1	1610	85,09	3,35	12,70	41,28	26,99	2,38	25,40	27,78	0,50	PHP 1-3V335TB
		91,44	B-1	1610	92,71	3,65	12,70	41,28	26,99	2,38	25,40	27,78	0,59	PHP 1-3V365TB
		103,38	B-1	1610	104,65	4,12	12,70	41,28	26,99	2,38	25,40	27,78	0,91	PHP 1-3V412TB
		113,03	B-1	1610	114,30	4,50	12,70	41,28	26,99	2,38	25,40	27,78	1,04	PHP 1-3V450TB
		119,38	B-1	1610	120,65	4,75	12,70	41,28	26,99	2,38	25,40	27,78	1,18	PHP 1-3V475TB
		125,73	B-1	1610	127,00	5,00	12,70	41,28	26,99	2,38	25,40	27,78	1,32	PHP 1-3V500TB
		133,35	B-1	1610	134,62	5,30	12,70	41,28	26,99	2,38	25,40	27,78	1,50	PHP 1-3V530TB
		140,97	B-1	1610	142,24	5,60	12,70	41,28	26,99	2,38	25,40	27,78	1,68	PHP 1-3V560TB
		151,13	B-1	1610	152,40	6,00	12,70	41,28	26,99	2,38	25,40	27,78	1,91	PHP 1-3V600TB
		163,83	B-1	1610	165,10	6,50	12,70	41,28	26,99	2,38	25,40	27,78	2,27	PHP 1-3V650TB
		173,99	B-1	1610	175,26	6,90	12,70	41,28	26,99	2,38	25,40	27,78	2,54	PHP 1-3V690TB
		201,93	C-2	2517 ¹⁾	203,20	8,00	19,05	63,50	26,99	-	44,45	27,78	3,86	PHP 1-3V800TB
		267,97	C-2	2517 ¹⁾	269,24	10,60	19,05	63,50	26,99	-	44,45	27,78	6,35	PHP 1-3V1060TB
		354,33	C-3	2517 ¹⁾	355,60	14,00	19,05	63,50	26,99	-	44,45	27,78	9,07	PHP 1-3V1400TB
		481,33	C-3	3020	482,60	19,00	31,75	76,20	26,99	-	50,80	27,78	11,79	PHP 1-3V1900TB
		3V	2	66,04	B-1	1108	67,31	2,65	9,53	28,58	27,78	5,56	22,23	-
69,85	B-1			1108	71,12	2,80	9,53	28,58	27,78	12,70	22,23	27,78	0,41	PHP 2-3V280TB
74,93	B-1			1210	76,20	3,00	15,88	31,75	27,78	2,38	25,40	-	0,64	PHP 2-3V300TB
78,74	B-1			1210	80,01	3,15	15,88	31,75	27,78	12,70	25,40	27,78	0,45	PHP 2-3V315TB
83,82	B-1			1610	85,09	3,35	12,70	41,28	27,78	12,70	25,40	27,78	0,68	PHP 2-3V335TB
91,44	B-1			1610	92,71	3,65	12,70	41,28	27,78	2,38	25,40	-	0,73	PHP 2-3V365TB
103,38	B-1			1610	104,65	4,12	12,70	41,28	27,78	2,38	25,40	-	0,95	PHP 2-3V412TB
113,03	B-1			1610	114,30	4,50	12,70	41,28	27,78	2,38	25,40	-	1,22	PHP 2-3V450TB
119,38	B-1			1610	120,65	4,75	12,70	41,28	27,78	2,38	25,40	-	1,41	PHP 2-3V475TB
125,73	B-1			1610	127,00	5,00	12,70	41,28	27,78	2,38	25,40	-	1,63	PHP 2-3V500TB
133,35	B-1			1610	134,62	5,30	12,70	41,28	27,78	2,38	25,40	-	1,91	PHP 2-3V530TB
140,97	B-1			1610	142,24	5,60	12,70	41,28	27,78	2,38	25,40	-	2,18	PHP 2-3V560TB
151,13	B-1			1610	152,40	6,00	12,70	41,28	27,78	2,38	25,40	-	2,63	PHP 2-3V600TB
163,83	B-1			1610	165,10	6,50	12,70	41,28	27,78	2,38	25,40	-	3,18	PHP 2-3V650TB
173,99	B-1			1610	175,26	6,90	12,70	41,28	27,78	2,38	25,40	-	3,63	PHP 2-3V690TB
201,93	C-2			2517 ¹⁾	203,20	8,00	19,05	63,50	27,78	-	44,45	16,67	4,99	PHP 2-3V800TB
267,97	C-2			2517 ¹⁾	269,24	10,60	19,05	63,50	27,78	-	44,45	16,67	6,80	PHP 2-3V1060TB
354,33	C-3			2517 ¹⁾	355,60	14,00	19,05	63,50	27,78	-	44,45	16,67	9,98	PHP 2-3V1400TB
481,33	C-3			3020	482,60	19,00	31,75	76,20	27,78	3,18	50,80	23,02	14,51	PHP 2-3V1900TB
633,73	C-3			3020	635,00	25,00	31,75	76,20	27,78	3,18	50,80	19,84	20,41	PHP 2-3V2500TB
3V	3	69,85	B-1	1108	71,12	2,80	9,53	28,58	38,10	15,88	22,23	27,78	0,50	PHP 3-3V280TB
		74,93	B-1	1210	76,20	3,00	15,88	31,75	38,10	23,02	25,40	-	0,82	PHP 3-3V300TB
		78,74	B-1	1210	80,01	3,15	15,88	31,75	38,10	12,70	25,40	27,78	0,68	PHP 3-3V315TB
		83,82	B-1	1610	85,09	3,35	12,70	41,28	38,10	23,02	25,40	27,78	0,82	PHP 3-3V335TB
		91,44	B-1	1610	92,71	3,65	12,70	41,28	38,10	23,02	25,40	-	0,91	PHP 3-3V365TB
		103,38	B-1	1610	104,65	4,12	12,70	41,28	38,10	12,70	25,40	-	1,18	PHP 3-3V412TB
		113,03	B-1	1610	114,30	4,50	12,70	41,28	38,10	12,70	25,40	-	1,45	PHP 3-3V450TB
		119,38	B-1	1610	120,65	4,75	12,70	41,28	38,10	12,70	25,40	-	1,68	PHP 3-3V475TB
		125,73	B-1	1610	127,00	5,00	12,70	41,28	38,10	12,70	25,40	-	1,91	PHP 3-3V500TB
		133,35	B-1	1610	134,62	5,30	12,70	41,28	38,10	12,70	25,40	-	2,18	PHP 3-3V530TB
		140,97	B-1	1610	142,24	5,60	12,70	41,28	38,10	12,70	25,40	-	2,49	PHP 3-3V560TB
		151,13	B-1	2517 ¹⁾	152,40	6,00	19,05	63,50	38,10	3,97	44,45	10,32	3,36	PHP 3-3V600TB
		163,83	B-1	2517 ¹⁾	165,10	6,50	19,05	63,50	38,10	3,97	44,45	10,32	4,13	PHP 3-3V650TB
		173,99	B-1	2517 ¹⁾	175,26	6,90	19,05	63,50	38,10	3,97	44,45	10,32	4,54	PHP 3-3V690TB
		201,93	C-2	2517 ¹⁾	203,20	8,00	19,05	63,50	38,10	3,97	44,45	10,32	6,80	PHP 3-3V800TB

¹⁾ Taper bushing needs to conform to coarse thread series (UNC) of the ASME/ANSI standard. To complete designation, add U before bushing number and bore size at the end of designation, e.g. PHF TBU3535X70MM.

²⁾ Mass does not include bushings.

Narrow wedge belt pulleys

3V taper bushed

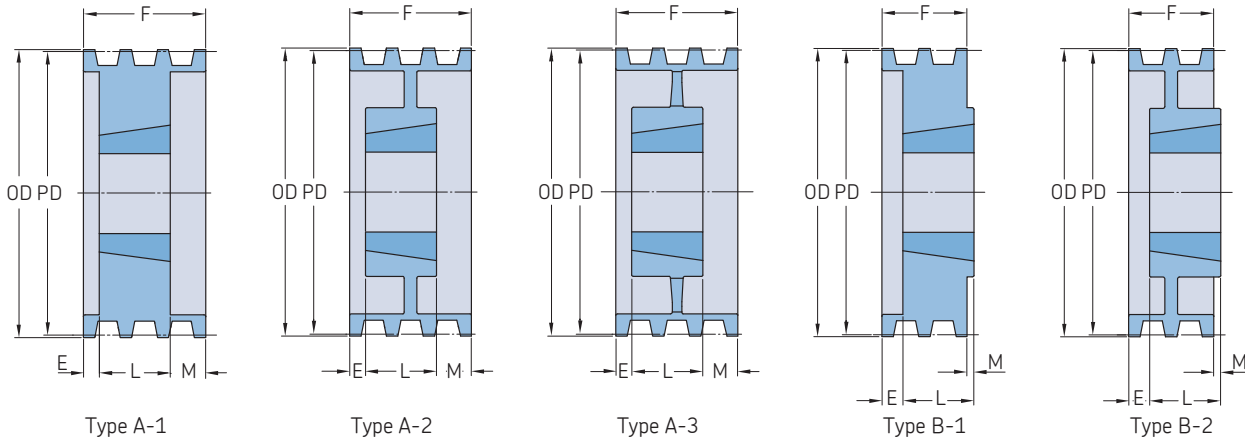

Section	Number of grooves	Pitch diameter PD	Pulley type	Bushing number	Dimensions		B		F	E	L	M	Mass ²⁾	Designation	
					Outer diameter OD	in.	Min.	Max.							
		mm			mm	in.								kg	
3V	3	267,97	C-2	2517 ¹⁾	269,24	10,60	19,05	63,50	38,10	–	44,45	6,35	8,16	PHF 3-3V1060TB	
		354,33	C-3	2517 ¹⁾	355,60	14,00	19,05	63,50	38,10	–	44,45	6,35	11,34	PHF 3-3V1400TB	
		481,33	C-3	3020	482,60	19,00	31,75	76,20	38,10	–	50,80	12,70	15,42	PHF 3-3V1900TB	
		633,73	C-3	3020	635,00	25,00	31,75	76,20	38,10	–	50,80	12,70	22,23	PHF 3-3V2500TB	
		849,63	C-3	3020	850,90	33,50	31,75	76,20	38,10	6,35	50,80	6,35	30,39	PHF 3-3V3500TB	
3V	4	69,85	B-1	1108	71,12	2,80	9,53	28,58	48,42	33,34	22,23	27,78	0,59	PHF 4-3V280TB	
		74,93	B-1	1210	76,20	3,00	15,88	31,75	48,42	23,02	25,40	–	0,95	PHF 4-3V300TB	
		78,74	B-1	1210	80,01	3,15	15,88	31,75	48,42	33,34	25,40	27,78	0,86	PHF 4-3V315TB	
		83,82	B-1	1610	85,09	3,35	12,70	41,28	48,42	23,02	25,40	–	1,00	PHF 4-3V335TB	
		91,44	B-1	1610	92,71	3,65	12,70	41,28	48,42	23,02	25,40	–	0,91	PHF 4-3V365TB	
		103,38	B-1	1610	104,65	4,12	12,70	41,28	48,42	23,02	25,40	–	1,36	PHF 4-3V412TB	
		113,03	B-1	1610	114,30	4,50	12,70	41,28	48,42	23,02	25,40	–	1,68	PHF 4-3V450TB	
		119,38	B-1	1610	120,65	4,75	12,70	41,28	48,42	23,02	25,40	–	1,91	PHF 4-3V475TB	
		125,73	B-1	1610	127,00	5,00	12,70	41,28	48,42	23,02	25,40	–	2,18	PHF 4-3V500TB	
		133,35	B-1	1610	134,62	5,30	12,70	41,28	48,42	23,02	25,40	–	2,49	PHF 4-3V530TB	
		140,97	B-1	1610	142,24	5,60	12,70	41,28	48,42	23,02	25,40	–	2,81	PHF 4-3V560TB	
		151,13	B-1	2517 ¹⁾	152,40	6,00	19,05	63,50	48,42	3,97	44,45	–	3,63	PHF 4-3V600TB	
		163,83	B-1	2517 ¹⁾	165,10	6,50	19,05	63,50	48,42	3,97	44,45	–	4,54	PHF 4-3V650TB	
		173,99	B-1	2517 ¹⁾	175,26	6,90	19,05	63,50	48,42	3,97	44,45	–	5,44	PHF 4-3V690TB	
		201,93	B-1	2517 ¹⁾	203,20	8,00	19,05	63,50	48,42	3,97	44,45	–	8,16	PHF 4-3V800TB	
		267,97	A-2	2517 ¹⁾	269,24	10,60	19,05	63,50	48,42	3,97	44,45	–	9,07	PHF 4-3V1060TB	
		354,33	C-3	2517 ¹⁾	355,60	14,00	19,05	63,50	48,42	–	44,45	3,97	13,15	PHF 4-3V1400TB	
		481,33	C-3	3020	482,60	19,00	31,75	76,20	48,42	–	76,20	27,78	20,41	PHF 4-3V1900TB	
		633,73	C-3	3020	635,00	25,00	31,75	76,20	48,42	–	76,20	27,78	28,58	PHF 4-3V2500TB	
		849,63	C-3	3030	850,90	33,50	31,75	76,20	48,42	13,89	76,20	13,89	36,74	PHF 4-3V3350TB	
3V	5	119,38	B-1	2517 ¹⁾	120,65	4,75	19,05	63,50	74,61	14,29	44,45	–	1,72	PHF 5-3V475TB	
		125,73	B-1	2517 ¹⁾	127,00	5,00	19,05	63,50	74,61	14,29	44,45	–	2,18	PHF 5-3V500TB	
		133,35	B-1	2517 ¹⁾	134,62	5,30	19,05	63,50	74,61	14,29	44,45	–	2,68	PHF 5-3V530TB	
		140,97	B-1	2517 ¹⁾	142,24	5,60	19,05	63,50	74,61	14,29	44,45	–	3,18	PHF 5-3V560TB	
		151,13	B-1	2517 ¹⁾	152,40	6,00	19,05	63,50	74,61	14,29	44,45	–	3,95	PHF 5-3V600TB	
		163,83	B-1	2517 ¹⁾	165,10	6,50	19,05	63,50	74,61	14,29	44,45	–	4,99	PHF 5-3V650TB	
		173,99	B-1	2517 ¹⁾	175,26	6,90	19,05	63,50	74,61	14,29	44,45	–	5,90	PHF 5-3V690TB	
		201,93	B-1	2517 ¹⁾	203,20	8,00	19,05	63,50	74,61	14,29	44,45	–	8,62	PHF 5-3V800TB	
		267,97	B-2	2517 ¹⁾	269,24	10,60	19,05	63,50	74,61	14,29	44,45	–	11,79	PHF 5-3V1060TB	
		354,33	C-3	2517 ¹⁾	355,60	14,00	19,05	63,50	74,61	–	44,45	14,29	15,42	PHF 5-3V1400TB	
		481,33	C-3	3030	482,60	19,00	31,75	76,20	74,61	–	76,20	17,46	21,32	PHF 5-3V1900TB	
		633,73	C-3	3030	635,00	25,00	31,75	76,20	74,61	–	76,20	17,46	29,94	PHF 5-3V2500TB	
		849,63	C-3	3030	850,90	33,50	31,75	76,20	74,61	8,73	76,20	17,46	39,01	PHF 5-3V3350TB	
3V	6	119,38	B-1	2517 ¹⁾	120,65	4,75	19,05	63,50	69,06	24,61	44,45	–	2,00	PHF 6-3V475TB	
		125,73	B-1	2517 ¹⁾	127,00	5,00	19,05	63,50	69,06	24,61	44,45	–	2,45	PHF 6-3V500TB	
		133,35	B-1	2517 ¹⁾	134,62	5,30	19,05	63,50	69,06	24,61	44,45	–	2,95	PHF 6-3V530TB	
		140,97	B-1	2517 ¹⁾	142,24	5,60	19,05	63,50	69,06	24,61	44,45	–	3,49	PHF 6-3V560TB	
		151,13	B-1	2517 ¹⁾	152,40	6,00	19,05	63,50	69,06	24,61	44,45	–	4,31	PHF 6-3V600TB	
		163,83	B-1	2517 ¹⁾	165,10	6,50	19,05	63,50	69,06	24,61	44,45	–	5,44	PHF 6-3V650TB	
		173,99	B-1	2517 ¹⁾	175,26	6,90	19,05	63,50	69,06	24,61	44,45	–	5,90	PHF 6-3V690TB	
		201,93	B-1	2517 ¹⁾	203,20	8,00	19,05	63,50	69,06	24,61	44,45	–	9,07	PHF 6-3V800TB	
		267,97	B-2	2517 ¹⁾	269,24	10,60	19,05	63,50	69,06	24,61	44,45	–	13,15	PHF 6-3V1060TB	
		354,33	B-3	2517 ¹⁾	355,60	14,00	19,05	63,50	69,06	5,56	44,45	19,05	18,60	PHF 6-3V1400TB	
		481,33	C-3	3020	482,60	19,00	31,75	76,20	69,06	–	76,20	7,14	23,13	PHF 6-3V1900TB	
		633,73	C-3	3030	635,00	25,00	31,75	76,20	69,06	–	76,20	7,14	32,66	PHF 6-3V2500TB	
		849,63	C-3	3030	850,90	33,50	31,75	76,20	69,06	3,57	76,20	3,57	41,73	PHF 6-3V3350TB	
3V	8	119,38	B-1	2517 ¹⁾	120,65	4,75	19,05	63,50	89,69	45,24	44,45	–	2,63	PHF 8-3V475TB	
		125,73	B-1	2517 ¹⁾	127,00	5,00	19,05	63,50	89,69	45,24	44,45	–	2,90	PHF 8-3V500TB	

¹⁾ Taper bushing needs to conform to coarse thread series (UNC) of the ASME/ANSI standard. To complete designation, add U before bushing number and bore size at the end of designation, e.g. PHF TBU3535X70MM.

²⁾ Mass does not include bushings.

Narrow wedge belt pulleys

3V taper bushed | 5V taper bushed

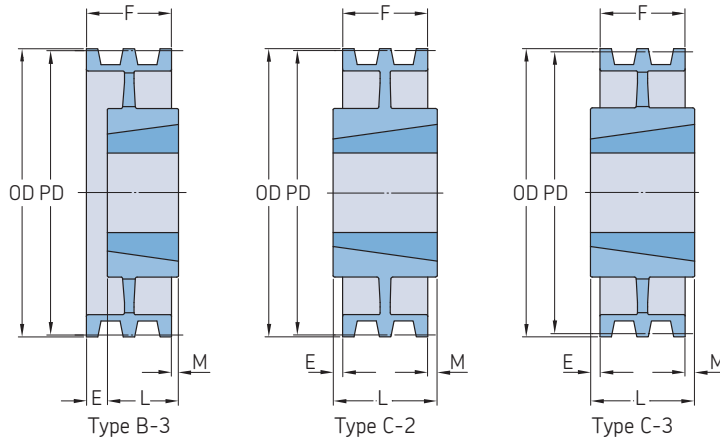

Section	Number of grooves	Pitch diameter PD	Pulley type	Bushing number	Dimensions		B Min.	Max.	F	E	L	M	Mass ²⁾ kg	Designation	
					Outer diameter OD	in.									
<hr/>															
3V	8	133,35	A-1	2517 ¹⁾	134,62	5,30	19,05	63,50	89,69	26,19	44,45	19,05	3,54	PHP 8-3V530TB	
		140,97	A-1	2517 ¹⁾	142,24	5,60	19,05	63,50	89,69	6,35	44,45	38,89	4,17	PHP 8-3V560TB	
		151,13	A-1	2517 ¹⁾	152,40	6,00	19,05	63,50	89,69	6,35	44,45	38,89	4,99	PHP 8-3V600TB	
		163,83	A-1	2517 ¹⁾	165,10	6,50	19,05	63,50	89,69	6,35	44,45	38,89	6,35	PHP 8-3V650TB	
		173,99	A-1	2517 ¹⁾	175,26	6,90	19,05	63,50	89,69	6,35	44,45	38,89	7,26	PHP 8-3V690TB	
		201,93	A-1	3020	203,20	8,00	31,75	76,20	89,69	12,70	50,80	26,19	9,98	PHP 8-3V800TB	
		267,97	A-2	3020	269,24	10,60	31,75	76,20	89,69	12,70	50,80	26,19	12,70	PHP 8-3V1060TB	
		354,33	A-3	3020	355,60	14,00	31,75	76,20	89,69	-	76,20	13,49	23,59	PHP 8-3V1400TB	
	481,33	A-3	3535 ¹⁾	482,60	19,00	50,80	100,01	89,69	-	88,90	0,79	30,39	PHP 8-3V1900TB		
	633,73	A-3	3535 ¹⁾	635,00	25,00	50,80	100,01	89,69	-	88,90	0,79	42,18	PHP 8-3V2500TB		
	849,63	C-3	4040	850,90	33,50	44,45	112,71	89,69	23,81	101,60	23,81	71,21	PHP 8-3V3350TB		
	3V	10	119,38	B-1	2517 ¹⁾	120,65	4,75	19,05	63,50	110,33	65,88	44,45	-	3,18	PHP 10-3V475TB
			125,73	B-1	2517 ¹⁾	127,00	5,00	19,05	63,50	110,33	65,88	44,45	19,05	3,63	PHP 10-3V500TB
			133,35	A-1	2517 ¹⁾	134,62	5,30	19,05	63,50	110,33	65,88	44,45	-	4,08	PHP 10-3V530TB
			140,97	A-1	2517 ¹⁾	142,24	5,60	19,05	63,50	110,33	12,70	44,45	53,18	4,99	PHP 10-3V560TB
			151,13	A-1	2517 ¹⁾	152,40	6,00	19,05	63,50	110,33	12,70	44,45	53,18	5,90	PHP 10-3V600TB
163,83			A-1	2517 ¹⁾	165,10	6,50	19,05	63,50	110,33	12,70	44,45	53,18	6,80	PHP 10-3V650TB	
173,99			A-1	2517 ¹⁾	175,26	6,90	19,05	63,50	110,33	12,70	44,45	53,18	8,16	PHP 10-3V690TB	
201,93			A-1	3020	203,20	8,00	31,75	76,20	110,33	6,35	50,80	53,18	10,43	PHP 10-3V800TB	
267,97			A-2	3020	269,24	10,60	31,75	76,20	110,33	21,43	50,80	38,10	14,06	PHP 10-3V1060TB	
354,33			A-2	3535 ¹⁾	355,60	14,00	50,80	88,90	110,33	-	88,90	21,43	22,68	PHP 10-3V1400TB	
481,33		A-3	3535 ¹⁾	482,60	19,00	50,80	88,90	110,33	-	88,90	21,43	34,02	PHP 10-3V1900TB		
633,73		A-3	4040	635,00	25,00	44,45	112,71	110,33	-	101,60	8,73	55,34	PHP 10-3V2500TB		
849,63		A-3	4040	850,90	33,50	44,45	112,71	110,33	4,37	101,60	4,37	78,02	PHP 10-3V3350TB		
5V		2	177,80	B-1	2517 ¹⁾	180,34	7,10	19,05	63,50	42,86	1,59	44,45	-	4,54	PHP 2-5V710TB
			187,96	B-1	2517 ¹⁾	190,50	7,50	19,05	63,50	42,86	1,59	44,45	-	5,44	PHP 2-5V750TB
			200,66	B-1	2517 ¹⁾	203,20	8,00	19,05	63,50	42,86	1,59	44,45	-	6,35	PHP 2-5V800TB
			213,36	B-2	2517 ¹⁾	215,90	8,50	19,05	63,50	42,86	1,59	44,45	-	5,90	PHP 2-5V850TB
			226,06	B-2	2517 ¹⁾	228,60	9,00	19,05	63,50	42,86	1,59	44,45	-	7,26	PHP 2-5V900TB
	232,41		C-2	3020	234,95	9,25	31,75	76,20	42,86	-	50,80	7,94	7,71	PHP 2-5V925TB	
	245,11		C-2	3020	247,65	9,75	31,75	76,20	42,86	-	50,80	7,94	8,62	PHP 2-5V975TB	
	259,08		C-2	3020	261,62	10,30	31,75	76,20	42,86	-	50,80	7,94	9,98	PHP 2-5V1030TB	
	274,32		C-2	3020	276,86	10,90	31,75	76,20	42,86	-	50,80	7,94	10,89	PHP 2-5V1090TB	
	297,18		C-2	3020	299,72	11,80	31,75	76,20	42,86	-	50,80	7,94	11,79	PHP 2-5V1180TB	
	314,96	C-2	3020	317,50	12,50	31,75	76,20	42,86	-	50,80	7,94	12,70	PHP 2-5V1250TB		
	332,74	C-3	3020	335,28	13,20	31,75	76,20	42,86	-	50,80	7,94	9,53	PHP 2-5V1320TB		
	353,06	C-3	3020	355,60	14,00	31,75	76,20	42,86	-	50,80	7,94	10,43	PHP 2-5V1400TB		
	378,46	C-3	3020	381,00	15,00	31,75	76,20	42,86	-	50,80	7,94	11,79	PHP 2-5V1500TB		
	403,86	C-3	3020	406,40	16,00	31,75	76,20	42,86	-	50,80	7,94	12,70	PHP 2-5V1600TB		
	535,94	C-3	3535 ¹⁾	538,48	21,20	50,80	100,01	42,86	9,53	88,90	36,51	23,13	PHP 2-5V2120TB		
	708,66	C-3	3535 ¹⁾	711,20	28,00	50,80	100,01	42,86	9,53	88,90	36,51	31,30	PHP 2-5V2800TB		
	5V	3	177,80	B-1	2517 ¹⁾	180,34	7,10	19,05	63,50	60,33	15,88	44,45	-	5,90	PHP 3-5V710TB
187,96			B-1	2517 ¹⁾	190,50	7,50	19,05	63,50	60,33	15,88	44,45	-	6,80	PHP 3-5V750TB	
200,66			B-1	2517 ¹⁾	203,20	8,00	19,05	63,50	60,33	15,88	44,45	-	8,16	PHP 3-5V800TB	
213,36			B-2	2517 ¹⁾	215,90	8,50	19,05	63,50	60,33	15,88	44,45	-	9,07	PHP 3-5V850TB	
226,06			B-2	2517 ¹⁾	228,60	9,00	19,05	63,50	60,33	15,88	44,45	-	9,07	PHP 3-5V900TB	
232,41			A-2	3020	234,95	9,25	31,75	76,20	60,33	-	50,80	9,53	9,53	PHP 3-5V925TB	
245,11		A-2	3020	247,65	9,75	31,75	76,20	60,33	-	50,80	9,53	10,89	PHP 3-5V975TB		
259,08		A-2	3020	261,62	10,30	31,75	76,20	60,33	-	50,80	9,53	11,34	PHP 3-5V1030TB		
274,32		A-2	3020	276,86	10,90	31,75	76,20	60,33	-	50,80	9,53	12,25	PHP 3-5V1090TB		
297,18		A-2	3020	299,72	11,80	31,75	76,20	60,33	-	50,80	9,53	13,15	PHP 3-5V1180TB		
314,96	A-3	3020	317,50	12,50	31,75	76,20	60,33	-	50,80	9,53	14,51	PHP 3-5V1250TB			

¹⁾ Taper bushing needs to conform to coarse thread series (UNC) of the ASME/ANSI standard. To complete designation, add U before bushing number and bore size at the end of designation, e.g. PHF TBU3535X70MM.

²⁾ Mass does not include bushings.

Narrow wedge belt pulleys

5V taper bushed

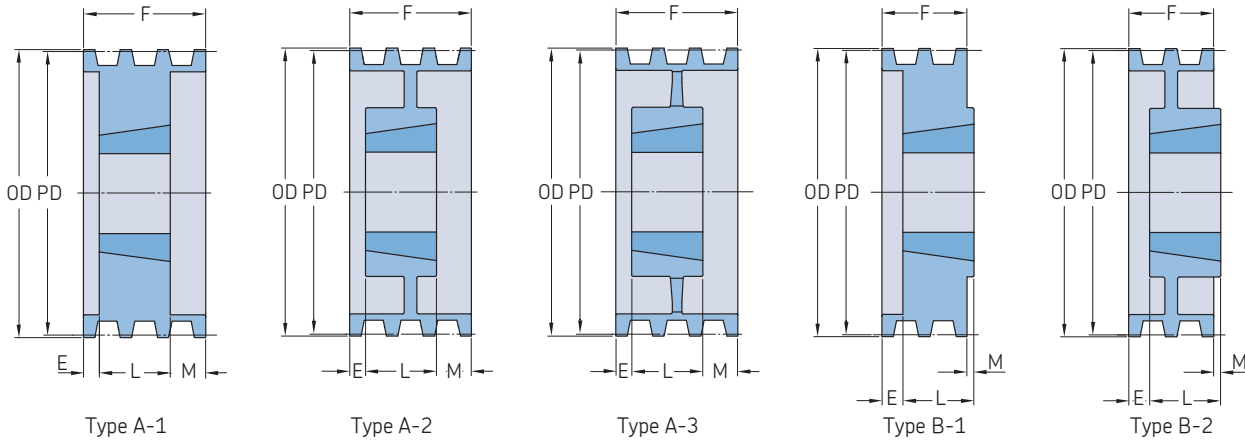

Section	Number of grooves	Pitch diameter PD	Pulley type	Bushing number	Dimensions		B Min.	Max.	F	E	L	M	Mass ²⁾	Designation	
					Outer diameter OD	in.									
		mm			mm	in.							kg		
5V	3	332,74	A-3	3020	335,28	13,20	31,75	76,20	60,33	-	50,80	9,53	15,42	PHF 3-5V1320TB	
		353,06	A-3	3020	355,60	14,00	31,75	76,20	60,33	-	50,80	9,53	16,33	PHF 3-5V1400TB	
		378,46	A-3	3020	381,00	15,00	31,75	76,20	60,33	-	50,80	9,53	16,78	PHF 3-5V1500TB	
		403,86	A-3	3020	406,40	16,00	31,75	76,20	60,33	-	50,80	9,53	17,24	PHF 3-5V1600TB	
		535,94	C-3	3535 ¹⁾	538,48	21,20	50,80	100,01	60,33	-	88,90	28,58	29,48	PHF 3-5V2120TB	
		708,66	C-3	3535 ¹⁾	711,20	28,00	50,80	100,01	60,33	-	88,90	28,58	42,18	PHF 3-5V2800TB	
	949,96	C-3	4040	952,50	37,50	44,45	112,71	60,33	12,70	101,60	28,58	64,41	PHF 3-5V3750TB		
	1267,46	C-3	4040	1270,00	50,00	44,45	112,71	60,33	12,70	101,60	28,58	91,63	PHF 3-5V5000TB		
	5V	4	177,80	B-1	2517 ¹⁾	180,34	7,10	19,05	63,50	77,79	33,34	44,45	-	6,80	PHF 4-5V710TB
			187,96	B-1	2517 ¹⁾	190,50	7,50	19,05	63,50	77,79	33,34	44,45	-	8,16	PHF 4-5V750TB
			200,66	B-1	2517 ¹⁾	203,20	8,00	19,05	63,50	77,79	33,34	44,45	-	9,53	PHF 4-5V800TB
			213,36	B-2	2517 ¹⁾	215,90	8,50	19,05	63,50	77,79	33,34	44,45	-	9,07	PHF 4-5V850TB
226,06			B-2	2517 ¹⁾	228,60	9,00	19,05	63,50	77,79	33,34	44,45	-	9,98	PHF 4-5V900TB	
232,41			A-1	3020	234,95	9,25	31,75	76,20	77,79	12,70	50,80	14,29	12,25	PHF 4-5V925TB	
245,11			A-1	3020	247,65	9,75	31,75	76,20	77,79	12,70	50,80	14,29	14,06	PHF 4-5V975TB	
259,08			A-2	3020	261,62	10,30	31,75	76,20	77,79	12,70	50,80	14,29	12,70	PHF 4-5V1030TB	
274,32			A-2	3020	276,86	10,90	31,75	76,20	77,79	12,70	50,80	14,29	14,06	PHF 4-5V1090TB	
297,18			A-2	3020	299,72	11,80	31,75	76,20	77,79	12,70	50,80	14,29	15,42	PHF 4-5V1180TB	
314,96			A-2	3020	317,50	12,50	31,75	76,20	77,79	-	76,20	1,59	18,14	PHF 4-5V1250TB	
332,74			A-3	3020	335,28	13,20	31,75	76,20	77,79	-	76,20	1,59	19,05	PHF 4-5V1320TB	
353,06		C-2	3535 ¹⁾	355,60	14,00	50,80	100,01	77,79	-	88,90	11,11	21,77	PHF 4-5V1400TB		
378,46		C-3	3535 ¹⁾	381,00	15,00	50,80	100,01	77,79	-	88,90	11,11	23,59	PHF 4-5V1500TB		
403,86		C-3	3535 ¹⁾	406,40	16,00	50,80	100,01	77,79	-	88,90	11,11	24,04	PHF 4-5V1600TB		
535,94		C-3	3535 ¹⁾	538,48	21,20	50,80	100,01	77,79	-	88,90	11,11	32,66	PHF 4-5V2120TB		
708,66		C-3	3535 ¹⁾	711,20	28,00	50,80	100,01	77,79	-	88,90	11,11	46,72	PHF 4-5V2800TB		
949,96		C-3	4040	952,50	37,50	44,45	112,71	77,79	-	101,60	23,81	78,02	PHF 4-5V3750TB		
1267,46		C-3	4040	1270,00	50,00	44,45	112,71	77,79	-	101,60	23,81	100,70	PHF 4-5V5000TB		
5V		5	177,80	A-1	3020	180,34	7,10	31,75	76,20	95,25	12,70	50,80	31,75	7,26	PHF 5-5V710TB
			187,96	A-1	3020	190,50	7,50	31,75	76,20	95,25	12,70	50,80	31,75	8,16	PHF 5-5V750TB
			200,66	A-1	3020	203,20	8,00	31,75	76,20	95,25	12,70	50,80	31,75	9,98	PHF 5-5V800TB
			213,36	A-1	3020	215,90	8,50	31,75	76,20	95,25	12,70	50,80	31,75	11,79	PHF 5-5V850TB
			226,06	A-1	3020	228,60	9,00	31,75	76,20	95,25	12,70	50,80	31,75	13,15	PHF 5-5V900TB
	232,41		A-1	3020	234,95	9,25	31,75	76,20	95,25	12,70	50,80	31,75	13,61	PHF 5-5V925TB	
	245,11		A-1	3020	247,65	9,75	31,75	76,20	95,25	12,70	50,80	31,75	15,42	PHF 5-5V975TB	
	259,08		A-2	3020	261,62	10,30	31,75	76,20	95,25	12,70	50,80	31,75	14,51	PHF 5-5V1030TB	
	274,32		A-2	3020	276,86	10,90	31,75	76,20	95,25	12,70	50,80	31,75	15,42	PHF 5-5V1090TB	
	297,18		A-2	3020	299,72	11,80	31,75	76,20	95,25	12,70	50,80	31,75	17,69	PHF 5-5V1180TB	
	314,96		A-2	3535 ¹⁾	317,50	12,50	50,80	100,01	95,25	-	88,90	6,35	24,49	PHF 5-5V1250TB	
	332,74		A-2	3535 ¹⁾	335,28	13,20	50,80	100,01	95,25	-	88,90	6,35	25,85	PHF 5-5V1320TB	
	353,06	A-2	3535 ¹⁾	355,60	14,00	50,80	100,01	95,25	-	88,90	6,35	24,49	PHF 5-5V1400TB		
	378,46	A-3	3535 ¹⁾	381,00	15,00	50,80	100,01	95,25	-	88,90	6,35	25,40	PHF 5-5V1500TB		
	403,86	A-3	3535 ¹⁾	406,40	16,00	50,80	100,01	95,25	-	88,90	6,35	26,31	PHF 5-5V1600TB		
	535,94	C-3	4040	538,48	21,20	44,45	112,71	95,25	-	101,60	6,35	41,73	PHF 5-5V2120TB		
	708,66	C-3	4040	711,20	28,00	44,45	112,71	95,25	-	101,60	6,35	53,07	PHF 5-5V2800TB		
	949,96	C-3	4040	952,50	37,50	44,45	112,71	95,25	-	101,60	6,35	82,55	PHF 5-5V3750TB		
	1267,46	C-3	4545	1270,00	50,00	57,15	125,41	95,25	-	114,30	19,05	125,19	PHF 5-5V5000TB		
	5V	6	177,80	A-1	3020	180,34	7,10	31,75	76,20	112,71	19,05	50,80	42,86	8,16	PHF 6-5V710 TB
			187,96	A-1	3020	190,50	7,50	31,75	76,20	112,71	19,05	50,80	42,86	9,07	PHF 6-5V750 TB
			200,66	A-1	3020	203,20	8,00	31,75	76,20	112,71	19,05	50,80	42,86	10,89	PHF 6-5V800 TB
			213,36	A-1	3020	215,90	8,50	31,75	76,20	112,71	19,05	50,80	42,86	12,70	PHF 6-5V850 TB
			226,06	A-1	3020	228,60	9,00	31,75	76,20	112,71	19,05	50,80	42,86	13,61	PHF 6-5V900 TB
232,41			A-1	3535 ¹⁾	234,95	9,25	50,80	100,01	112,71	-	88,90	23,81	17,69	PHF 6-5V925 TB	
245,11		A-1	3535 ¹⁾	247,65	9,75	50,80	100,01	112,71	-	88,90	23,81	20,87	PHF 6-5V975 TB		

¹⁾ Taper bushing needs to conform to coarse thread series (UNC) of the ASME/ANSI standard. To complete designation, add U before bushing number and bore size at the end of designation, e.g. PHF TBU3535X70MM.

²⁾ Mass does not include bushings.

Narrow wedge belt pulleys

5V taper bushed | 8V taper bushed

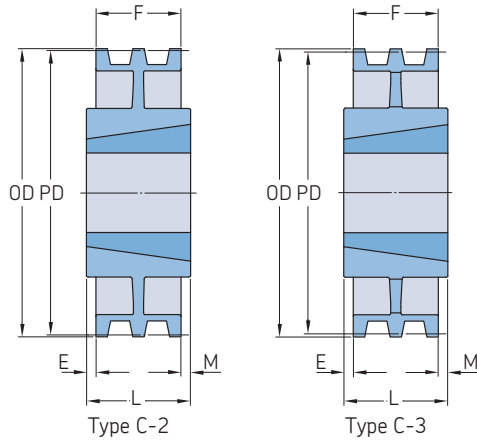

Section	Number of grooves	Pitch diameter PD	Pulley type	Bushing number	Dimensions		Bushing		F	E	L	M	Mass ²⁾	Designation		
					Outer diameter OD	PD	Min.	Max.								
		mm			mm	in.								kg		
5V	6	259,08	A-1	3535 ¹⁾	261,62	10,30	50,80	100,01	112,71	-	88,90	23,81	24,49	PHP 6-5V1030 TB		
		274,32	A-1	3535 ¹⁾	276,86	10,90	50,80	100,01	112,71	-	88,90	23,81	28,12	PHP 6-5V1090 TB		
		297,18	A-2	3535 ¹⁾	299,72	11,80	50,80	100,01	112,71	-	88,90	23,81	24,95	PHP 6-5V1180 TB		
		314,96	A-2	3535 ¹⁾	317,50	12,50	50,80	100,01	112,71	-	88,90	23,81	26,31	PHP 6-5V1250 TB		
		332,74	A-2	3535 ¹⁾	335,28	13,20	50,80	100,01	112,71	-	88,90	23,81	27,22	PHP 6-5V1320 TB		
		353,06	A-2	3535 ¹⁾	355,60	14,00	50,80	100,01	112,71	-	88,90	23,81	26,76	PHP 6-5V1400 TB		
	5V	8	378,46	A-2	4040	381,00	15,00	44,45	112,71	112,71	-	101,60	11,11	37,19	PHP 6-5V1500 TB	
			403,86	A-2	4040	406,40	16,00	44,45	112,71	112,71	-	101,60	11,11	39,46	PHP 6-5V1600 TB	
			535,94	A-3	4040	538,48	21,20	44,45	112,71	112,71	-	101,60	11,11	46,27	PHP 6-5V2120 TB	
			708,66	A-3	4040	711,20	28,00	44,45	112,71	112,71	-	101,60	11,11	62,14	PHP 6-5V2800 TB	
			949,96	C-3	4545	952,50	37,50	57,15	125,41	112,71	-	114,30	1,59	100,24	PHP 6-5V3750 TB	
			1267,46	C-3	4545	1270,00	50,00	57,15	125,41	112,71	-	114,30	1,59	134,26	PHP 6-5V5000 TB	
		5V	10	177,80	A-1	3030	180,34	7,10	31,75	76,20	147,64	25,40	76,20	46,04	10,89	PHP 8-5V710TB
				187,96	A-1	3030	190,50	7,50	31,75	76,20	147,64	25,40	76,20	46,04	12,70	PHP 8-5V750TB
200,66				A-1	3030	203,20	8,00	31,75	76,20	147,64	25,40	76,20	46,04	14,97	PHP 8-5V800TB	
213,36				A-1	3030	215,90	8,50	31,75	76,20	147,64	25,40	76,20	46,04	17,24	PHP 8-5V850TB	
226,06				A-1	3535 ¹⁾	228,60	9,00	50,80	100,01	147,64	25,40	88,90	33,34	19,96	PHP 8-5V900TB	
232,41				A-1	3535 ¹⁾	234,95	9,25	50,80	100,01	147,64	25,40	88,90	33,34	20,41	PHP 8-5V925TB	
245,11				A-1	3535 ¹⁾	247,65	9,75	50,80	100,01	147,64	25,40	88,90	33,34	23,13	PHP 8-5V975TB	
259,08				A-1	3535 ¹⁾	261,62	10,30	50,80	100,01	147,64	25,40	88,90	33,34	27,22	PHP 8-5V1030TB	
274,32	A-1			3535 ¹⁾	276,86	10,90	50,80	100,01	147,64	25,40	88,90	33,34	30,84	PHP 8-5V1090TB		
297,18	A-2			3535 ¹⁾	299,72	11,80	50,80	100,01	147,64	25,40	88,90	33,34	28,58	PHP 8-5V1180TB		
314,96	A-2			4040	317,50	12,50	44,45	112,71	147,64	6,35	101,60	39,69	37,19	PHP 8-5V1250TB		
332,74	A-2			4040	335,28	13,20	44,45	112,71	147,64	6,35	101,60	39,69	37,19	PHP 8-5V1320TB		
353,06	A-2			4040	355,60	14,00	44,45	112,71	147,64	6,35	101,60	39,69	39,46	PHP 8-5V1400TB		
378,46	A-2			4040	381,00	15,00	44,45	112,71	147,64	6,35	101,60	39,69	44,00	PHP 8-5V1500TB		
403,86	A-2	4040	406,40	16,00	44,45	112,71	147,64	6,35	101,60	39,69	46,27	PHP 8-5V1600TB				
535,94	A-3	4040	538,48	21,20	44,45	112,71	147,64	6,35	101,60	39,69	55,34	PHP 8-5V2120TB				
708,66	A-3	4545	711,20	28,00	57,15	125,41	147,64	6,35	114,30	26,99	79,83	PHP 8-5V2800TB				
949,96	A-3	4545	952,50	37,50	57,15	125,41	147,64	6,35	114,30	26,99	122,92	PHP 8-5V3750TB				
1267,46	A-3	4545	1270,00	50,00	57,15	125,41	147,64	6,35	114,30	26,99	161,48	PHP 8-5V5000TB				
5V	4	312,42	A-1	4040	317,50	12,50	44,45	112,71	123,83	-	101,60	22,23	41,73	PHP 4-8V1250TB		
		330,20	A-1	4040	335,28	13,20	44,45	112,71	123,83	-	101,60	22,23	48,53	PHP 4-8V1320TB		
		350,52	A-1	4040	355,60	14,00	44,45	125,41	123,83	-	114,30	9,53	57,15	PHP 4-8V1400TB		

¹⁾ Taper bushing needs to conform to coarse thread series (UNC) of the ASME/ANSI standard. To complete designation, add U before bushing number and bore size at the end of designation, e.g. PHF TBU3535X70MM.

²⁾ Mass does not include bushings.

Narrow wedge belt pulleys

8V taper bushed

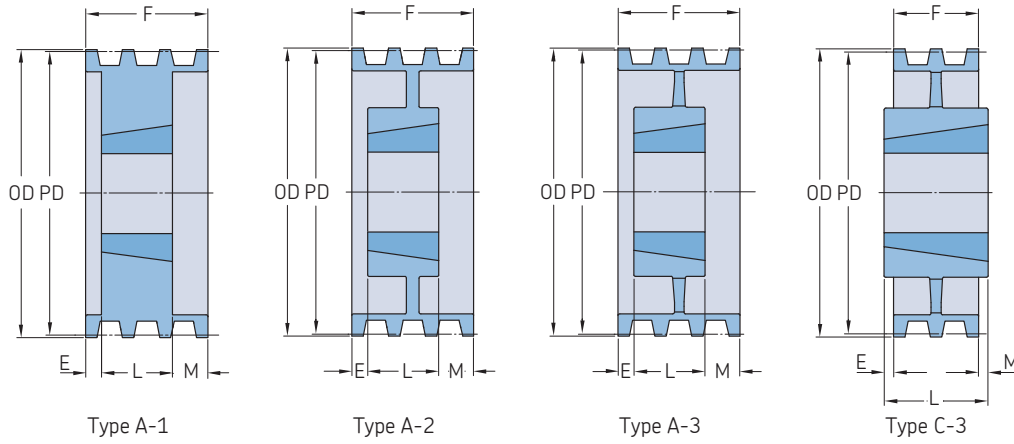

Section	Number of grooves	Pitch diameter PD	Pulley type	Bushing number	Dimensions		B		F	E	L	M	Mass*	Designation	
					Outer diameter OD		Min.	Max.							
		mm			mm	in.							kg		
8V	4	375,92	A-1	4040	381,00	15,00	44,45	125,41	123,83	-	114,30	9,53	52,62	PHP 4-8V1500TB	
		401,32	A-2	4040	406,40	16,00	44,45	125,41	123,83	-	114,30	9,53	57,15	PHP 4-8V1600TB	
		426,72	A-2	4040	431,80	17,00	44,45	125,41	123,83	-	114,30	9,53	61,69	PHP 4-8V1700TB	
		452,12	A-2	4040	457,20	18,00	44,45	125,41	123,83	-	114,30	9,53	66,22	PHP 4-8V1800TB	
		477,52	A-2	4040	482,60	19,00	44,45	125,41	123,83	-	114,30	9,53	73,03	PHP 4-8V1900TB	
		502,92	A-2	4545	508,00	20,00	57,15	125,41	123,83	-	114,30	9,53	77,56	PHP 4-8V2000TB	
	533,40	A-3	4545	538,48	21,20	57,15	125,41	123,83	-	114,30	9,53	66,22	PHP 4-8V2120TB		
	563,88	A-3	4545	568,96	22,40	57,15	125,41	123,83	-	114,30	9,53	73,03	PHP 4-8V2240TB		
	756,92	A-3	4545	762,00	30,00	57,15	125,41	123,83	-	114,30	9,53	113,85	PHP 4-8V3000TB		
	896,62	A-3	4545	901,70	35,50	57,15	125,41	123,83	-	114,30	9,53	129,27	PHP 4-8V3550TB		
	1010,92	C-3	5050	1016,00	40,00	69,85	127,00	123,83	-	127,00	3,18	143,34	PHP 4-8V4000TB		
	1125,22	C-3	5050	1130,30	44,50	69,85	127,00	123,83	-	127,00	3,18	185,07	PHP 4-8V4450TB		
	1341,12	C-3	5050	1346,20	53,00	69,85	127,00	123,83	-	127,00	3,18	215,91	PHP 4-8V5300TB		
	8V	5	312,42	A-1	4040	317,50	12,50	44,45	125,41	152,40	-	114,30	38,10	43,54	PHP 5-8V1250TB
			330,20	A-1	4040	335,28	13,20	44,45	125,41	152,40	-	114,30	38,10	52,62	PHP 5-8V1320TB
			350,52	A-1	4040	355,60	14,00	44,45	125,41	152,40	-	114,30	38,10	61,69	PHP 5-8V1400TB
			375,92	A-1	4040	381,00	15,00	44,45	125,41	152,40	-	114,30	38,10	59,42	PHP 5-8V1500TB
			401,32	A-1	4040	406,40	16,00	44,45	125,41	152,40	-	114,30	38,10	63,96	PHP 5-8V1600TB
426,72			A-2	4040	431,80	17,00	44,45	125,41	152,40	-	114,30	38,10	66,22	PHP 5-8V1700TB	
452,12		A-2	4040	457,20	18,00	44,45	125,41	152,40	-	114,30	38,10	70,76	PHP 5-8V1800TB		
477,52		A-2	4040	482,60	19,00	44,45	125,41	152,40	-	114,30	38,10	79,83	PHP 5-8V1900TB		
502,92		A-2	4545	508,00	20,00	57,15	125,41	152,40	-	114,30	38,10	84,37	PHP 5-8V2000TB		
533,40		A-3	4545	538,48	21,20	57,15	125,41	152,40	-	114,30	38,10	73,03	PHP 5-8V2120TB		
563,88		A-3	4545	568,96	22,40	57,15	125,41	152,40	-	114,30	38,10	79,83	PHP 5-8V2240TB		
624,84		A-3	4545	629,92	24,80	57,15	125,41	152,40	-	114,30	38,10	106,59	PHP 5-8V2480TB		
756,92		A-3	4545	762,00	30,00	57,15	125,41	152,40	-	114,30	38,10	122,92	PHP 5-8V3000TB		
896,62		A-3	4545	901,70	35,50	57,15	125,41	152,40	-	114,30	38,10	147,42	PHP 5-8V3550TB		
1010,92		A-3	5050	1016,00	40,00	69,85	127,00	152,40	-	127,00	25,40	158,76	PHP 5-8V4000TB		
1125,22		A-3	5050	1130,30	44,50	69,85	127,00	152,40	-	127,00	25,40	186,43	PHP 5-8V4450TB		
1341,12		A-3	5050	1346,20	53,00	69,85	127,00	152,40	-	127,00	25,40	256,28	PHP 5-8V5300TB		
8V		6	312,42	A-1	4545	317,50	12,50	57,15	125,41	155,58	12,70	114,30	53,98	47,63	PHP 6-8V1250TB
	330,20		A-1	4545	335,28	13,20	57,15	125,41	155,58	12,70	114,30	53,98	56,70	PHP 6-8V1320TB	
	350,52		A-1	4545	355,60	14,00	57,15	125,41	155,58	12,70	114,30	53,98	65,77	PHP 6-8V1400TB	
	375,92		A-1	4545	381,00	15,00	57,15	125,41	155,58	12,70	114,30	53,98	77,11	PHP 6-8V1500TB	
	401,32		A-2	4545	406,40	16,00	57,15	125,41	155,58	12,70	114,30	53,98	65,77	PHP 6-8V1600TB	
	426,72		A-2	4545	431,80	17,00	57,15	125,41	155,58	12,70	114,30	53,98	68,04	PHP 6-8V1700TB	
	452,12	A-2	4545	457,20	18,00	57,15	125,41	155,58	12,70	114,30	53,98	72,57	PHP 6-8V1800TB		
	477,52	A-2	4545	482,60	19,00	57,15	125,41	155,58	12,70	114,30	53,98	83,91	PHP 6-8V1900TB		
	502,92	A-2	4545	508,00	20,00	57,15	125,41	155,58	12,70	114,30	53,98	90,72	PHP 6-8V2000TB		
	533,40	A-3	4545	538,48	21,20	57,15	125,41	155,58	12,70	114,30	53,98	77,11	PHP 6-8V2120TB		
	563,88	A-3	4545	568,96	22,40	57,15	125,41	155,58	12,70	114,30	53,98	81,65	PHP 6-8V2240TB		
	624,84	A-3	4545	629,92	24,80	57,15	125,41	155,58	12,70	114,30	53,98	107,95	PHP 6-8V2480TB		
	756,92	A-3	5050	762,00	30,00	69,85	127,00	155,58	12,70	127,00	41,28	129,27	PHP 6-8V3000TB		
	896,62	A-3	5050	901,70	35,50	69,85	127,00	155,58	12,70	127,00	41,28	152,41	PHP 6-8V3550TB		
	1010,92	A-3	5050	1016,00	40,00	69,85	127,00	155,58	12,70	127,00	41,28	170,10	PHP 6-8V4000TB		
	1125,22	A-3	5050	1130,30	44,50	69,85	127,00	155,58	12,70	127,00	41,28	197,77	PHP 6-8V4450TB		
	1341,12	A-3	5050	1346,20	53,00	69,85	127,00	155,58	12,70	127,00	41,28	269,89	PHP 6-8V5300TB		
	8V	8	312,42	A-1	4545	317,50	12,50	57,15	125,41	238,13	38,10	114,30	85,73	56,70	PHP 8-8V1250TB
330,20			A-1	4545	335,28	13,20	57,15	125,41	238,13	38,10	114,30	85,73	61,23	PHP 8-8V1320TB	
350,52			A-1	4545	355,60	14,00	57,15	125,41	238,13	38,10	114,30	85,73	70,31	PHP 8-8V1400TB	
375,92			A-1	4545	381,00	15,00	57,15	125,41	238,13	38,10	114,30	85,73	81,65	PHP 8-8V1500TB	
401,32			A-1	4545	406,40	16,00	57,15	125,41	238,13	38,10	114,30	85,73	72,57	PHP 8-8V1600TB	

* Mass does not include bushings.

Narrow wedge belt pulleys

8V taper bushed

Section	Number of grooves	Pitch diameter PD	Pulley type	Bushing number	Dimensions		B Min.	Max.	F	E	L	M	Mass*	Designation		
					Outer diameter OD	in.										
–	–	mm	–	–	mm	in.							kg	–		
8V	8	426,72	A-2	5050	431,80	17,00	69,85	127,00	238,13	38,10	127,00	85,73	79,83	PHP 8-8V1700TB		
		452,12	A-2	5050	457,20	18,00	69,85	127,00	238,13	25,40	127,00	85,73	86,18	PHP 8-8V1800TB		
		477,52	A-2	5050	482,60	19,00	69,85	127,00	238,13	25,40	127,00	85,73	95,25	PHP 8-8V1900TB		
		502,92	A-2	5050	508,00	20,00	69,85	127,00	238,13	25,40	127,00	85,73	102,06	PHP 8-8V2000TB		
		533,40	A-2	5050	538,48	21,20	69,85	127,00	238,13	25,40	127,00	85,73	111,13	PHP 8-8V2120TB		
		563,88	A-3	5050	568,96	22,40	69,85	127,00	238,13	25,40	127,00	85,73	136,08	PHP 8-8V2240TB		
		624,84	A-3	5050	629,92	24,80	69,85	127,00	238,13	25,40	127,00	85,73	140,16	PHP 8-8V2480TB		
		756,92	A-3	5050	762,00	30,00	69,85	127,00	238,13	25,40	127,00	85,73	142,88	PHP 8-8V3000TB		
		896,62	A-3	5050	901,70	35,50	69,85	127,00	238,13	25,40	127,00	85,73	188,24	PHP 8-8V3550TB		
		1010,92	A-3	5050	1016,00	40,00	69,85	127,00	238,13	25,40	127,00	85,73	213,19	PHP 8-8V4000TB		
		1125,22	A-3	5050	1130,30	44,50	69,85	127,00	238,13	25,40	127,00	85,73	265,35	PHP 8-8V4450TB		
		1341,12	A-3	6050	1346,20	53,00	69,85	127,00	238,13	25,40	127,00	85,73	317,51	PHP 8-8V5300TB		
		8V	10	330,20	A-1	4545	335,28	13,20	57,15	125,41	295,28	25,40	114,30	155,58	68,04	PHP 10-8V1320TB
				350,52	A-1	4545	355,60	14,00	57,15	125,41	295,28	25,40	114,30	155,58	79,38	PHP 10-8V1400TB
				375,92	A-1	5050	381,00	15,00	69,85	127,00	295,28	25,40	127,00	142,88	79,38	PHP 10-8V1500TB
				401,32	A-1	5050	406,40	16,00	69,85	127,00	295,28	25,40	127,00	142,88	99,79	PHP 10-8V1600TB
426,72	A-2			5050	431,80	17,00	69,85	127,00	295,28	57,15	127,00	111,13	83,91	PHP 10-8V1700TB		
452,12	A-2			5050	457,20	18,00	69,85	127,00	295,28	57,15	127,00	111,13	99,79	PHP 10-8V1800TB		
477,52	A-2			5050	482,60	19,00	69,85	127,00	295,28	57,15	127,00	111,13	108,86	PHP 10-8V1900TB		
502,92	A-2			5050	508,00	20,00	69,85	127,00	295,28	57,15	127,00	111,13	117,93	PHP 10-8V2000TB		
533,40	A-2			5050	538,48	21,20	69,85	127,00	295,28	57,15	127,00	111,13	127,01	PHP 10-8V2120TB		
563,88	A-3			5050	568,96	22,40	69,85	127,00	295,28	57,15	127,00	111,13	151,95	PHP 10-8V2240TB		
624,84	A-3			5050	629,92	24,80	69,85	127,00	295,28	57,15	127,00	111,13	162,39	PHP 10-8V2480TB		
756,92	A-3			5050	762,00	30,00	69,85	127,00	295,28	57,15	127,00	111,13	167,83	PHP 10-8V3000TB		
896,62	A-3			5050	901,70	35,50	69,85	127,00	295,28	57,15	127,00	111,13	217,72	PHP 10-8V3550TB		
1010,92	A-3			5050	1016,00	40,00	69,85	127,00	295,28	57,15	127,00	111,13	249,48	PHP 10-8V4000TB		
1125,22	A-3			6050	1130,30	44,50	69,85	127,00	295,28	57,15	127,00	111,13	306,17	PHP 10-8V4450TB		
1341,12	A-3			6050	1346,20	53,00	69,85	127,00	295,28	57,15	127,00	111,13	394,63	PHP 10-8V5300TB		

* Mass does not include bushings.

Narrow wedge belt pulleys

3V QD bushed

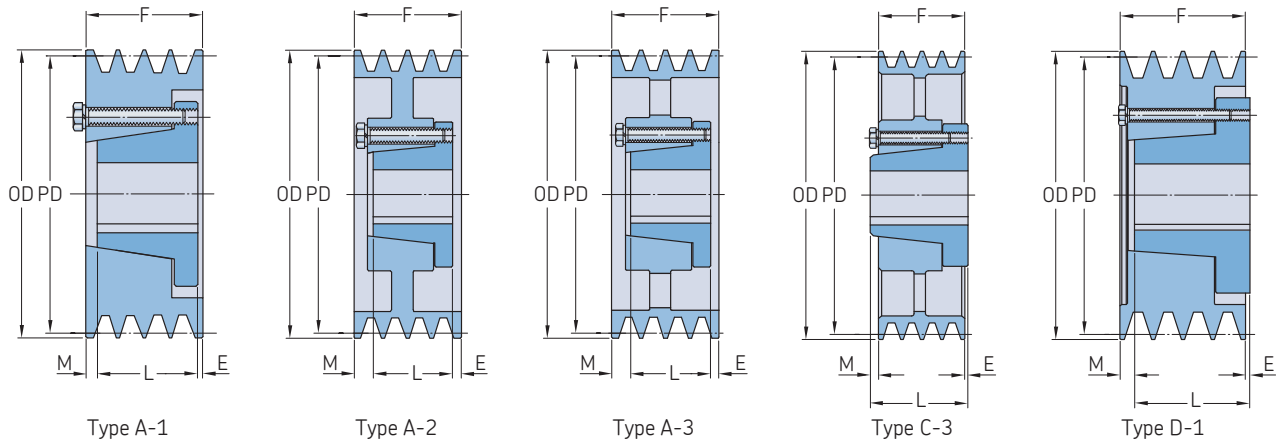

Section	Number of grooves	Pitch diameter PD	Pulley type	Bushing number	Dimensions		Bore		E	F	L	M	Mass*	Designation
					Outer diameter OD	in.	Min.	Max.						
3V	1	54,61	E-1	JA	55,88	2,20	12,70	31,75	15,88	17,46	25,40	24	0,2	PHP 1-3V220-JA
		58,42	E-1	JA	59,69	2,35	12,70	31,75	15,08	17,46	25,40	23	0,2	PHP 1-3V235-JA
		62,23	E-1	JA	63,50	2,50	12,70	31,75	15,08	17,46	25,40	23	0,2	PHP 1-3V250-JA
		66,04	D-1	JA	67,31	2,65	12,70	31,75	9,53	17,46	25,40	2	0,3	PHP 1-3V265-JA
		69,85	D-1	JA	71,12	2,80	12,70	31,75	9,53	17,46	25,40	2	0,3	PHP 1-3V280-JA
		74,93	D-1	JA	76,20	3,00	12,70	31,75	9,53	17,46	25,40	2	0,4	PHP 1-3V300-JA
		78,74	D-1	JA	80,01	3,15	12,70	31,75	9,53	17,46	25,40	2	0,4	PHP 1-3V315-JA
		83,82	D-1	JA	85,09	3,35	12,70	31,75	9,53	17,46	25,40	2	0,5	PHP 1-3V335-JA
		91,44	D-1	SH	92,71	3,65	12,70	41,28	16,67	17,46	33,34	1	0,6	PHP 1-3V365-SH
		103,38	D-1	SH	104,65	4,12	12,70	41,28	16,67	17,46	33,34	1	0,8	PHP 1-3V412-SH
		113,03	D-1	SH	114,30	4,50	12,70	41,28	16,67	17,46	33,34	1	1,0	PHP 1-3V450-SH
		119,38	D-1	SH	120,65	4,75	12,70	41,28	16,67	17,46	33,34	1	1,1	PHP 1-3V475-SH
		125,73	D-1	SH	127,00	5,00	12,70	41,28	16,67	17,46	33,34	1	1,2	PHP 1-3V500-SH
		133,35	D-1	SH	134,62	5,30	12,70	41,28	16,67	17,46	33,34	1	1,3	PHP 1-3V530-SH
		140,97	D-2	SH	142,24	5,60	12,70	41,28	16,67	17,46	33,34	1	1,4	PHP 1-3V560-SH
		151,13	D-2	SH	152,40	6,00	12,70	41,28	16,67	17,46	33,34	1	1,5	PHP 1-3V600-SH
		163,83	D-2	SH	165,10	6,50	12,70	41,28	16,67	17,46	33,34	1	1,9	PHP 1-3V650-SH
		173,99	D-3	SH	175,26	6,90	12,70	41,28	16,67	17,46	33,34	1	2,0	PHP 1-3V690-SH
		201,93	D-3	SDS	203,20	8,00	12,70	50,80	16,67	17,46	33,34	1	2,6	PHP 1-3V800-SDS
		267,97	D-3	SDS	269,24	10,60	12,70	50,80	16,67	17,46	33,34	1	3,6	PHP 1-3V1060-SDS
		354,33	C-3	SK	355,60	14,00	12,70	66,68	19,84	17,46	33,34	12	6,7	PHP 1-3V1400-SK
		481,33	C-3	SK	482,60	19,00	12,70	66,68	19,84	17,46	33,34	12	10,9	PHP 1-3V1900-SK
3V	2	54,61	E-1	JA	55,88	2,20	12,70	31,75	8,73	27,78	25,40	24	0,3	PHP 2-3V220-JA
		58,42	E-1	JA	59,69	2,35	12,70	31,75	25,40	27,78	25,40	23	0,3	PHP 2-3V235-JA
		62,23	E-1	JA	63,50	2,50	12,70	31,75	25,40	27,78	25,40	23	0,3	PHP 2-3V250-JA
		66,04	D-1	JA	67,31	2,65	12,70	31,75	9,53	27,78	25,40	12	0,4	PHP 2-3V265-JA
		69,85	D-1	JA	71,12	2,80	12,70	31,75	9,53	27,78	25,40	12	0,4	PHP 2-3V280-JA
		74,93	D-1	JA	76,20	3,00	12,70	31,75	9,53	27,78	25,40	12	0,5	PHP 2-3V300-JA
		78,74	D-1	JA	80,01	3,15	12,70	31,75	9,53	27,78	25,40	12	0,5	PHP 2-3V315-JA
		83,82	D-1	SH	85,09	3,35	12,70	41,28	13,49	27,78	33,34	8	0,6	PHP 2-3V335-SH
		91,44	D-1	SH	92,71	3,65	12,70	41,28	13,49	27,78	33,34	8	0,7	PHP 2-3V365-SH
		103,38	D-1	SH	104,65	4,12	12,70	41,28	8,73	27,78	33,34	3	1,0	PHP 2-3V412-SH
		113,03	D-1	SH	114,30	4,50	12,70	41,28	8,73	27,78	33,34	3	1,2	PHP 2-3V450-SH
		119,38	D-1	SH	120,65	4,75	12,70	41,28	8,73	27,78	33,34	3	1,4	PHP 2-3V475-SH
		125,73	D-1	SH	127,00	5,00	12,70	41,28	8,73	27,78	33,34	3	1,5	PHP 2-3V500-SH
		133,35	D-1	SH	134,62	5,30	12,70	41,28	8,73	27,78	33,34	3	1,8	PHP 2-3V530-SH
		140,97	D-2	SH	142,24	5,60	12,70	41,28	8,73	27,78	33,34	3	1,8	PHP 2-3V560-SH
		151,13	D-2	SH	152,40	6,00	12,70	41,28	8,73	27,78	33,34	3	2,0	PHP 2-3V600-SH
		163,83	D-2	SDS	165,10	6,50	12,70	50,80	8,73	27,78	33,34	3	2,7	PHP 2-3V650-SDS
		173,99	D-2	SDS	175,26	6,90	12,70	50,80	8,73	27,78	33,34	3	3,4	PHP 2-3V690-SDS
		201,93	D-3	SDS	203,20	8,00	12,70	50,80	8,73	27,78	33,34	3	3,9	PHP 2-3V800-SDS
		267,97	C-3	SK	269,24	10,60	12,70	66,68	13,49	27,78	33,34	8	5,7	PHP 2-3V1060-SK
		354,33	C-3	SK	355,60	14,00	12,70	66,68	13,49	27,78	33,34	8	8,9	PHP 2-3V1400-SK
		481,33	C-3	SK	482,60	19,00	12,70	66,68	13,49	27,78	33,34	8	12,3	PHP 2-3V1900-SK
		633,73	C-3	SF	635,00	25,00	12,70	74,61	15,08	27,78	52,39	10	17,2	PHP 2-3V2500-SF
3V	3	62,23	E-1	JA	63,50	2,50	12,70	31,75	35,72	38,10	25,40	23	0,4	PHP 3-3V250-JA
		66,04	D-1	JA	67,31	2,65	12,70	31,75	9,53	38,10	25,40	22	0,5	PHP 3-3V265-JA
		69,85	D-1	JA	71,12	2,80	12,70	31,75	9,53	38,10	25,40	22	0,6	PHP 3-3V280-JA
		74,93	E-1	SH	76,20	3,00	12,70	41,28	29,37	38,10	33,34	25	0,8	PHP 3-3V300-SH
		78,74	E-1	SH	80,01	3,15	12,70	41,28	29,37	38,10	33,34	25	0,8	PHP 3-3V315-SH
		83,82	D-1	SH	85,09	3,35	12,70	41,28	13,49	38,10	33,34	18	0,9	PHP 3-3V335-SH
		91,44	D-1	SH	92,71	3,65	12,70	41,28	13,49	38,10	33,34	18	1,0	PHP 3-3V365-SH
		103,38	A-1	SH	104,65	4,12	12,70	41,28	0,79	38,10	33,34	4	1,3	PHP 3-3V412-SH

* Mass does not include bushings.

Narrow wedge belt pulleys

3V QD bushed

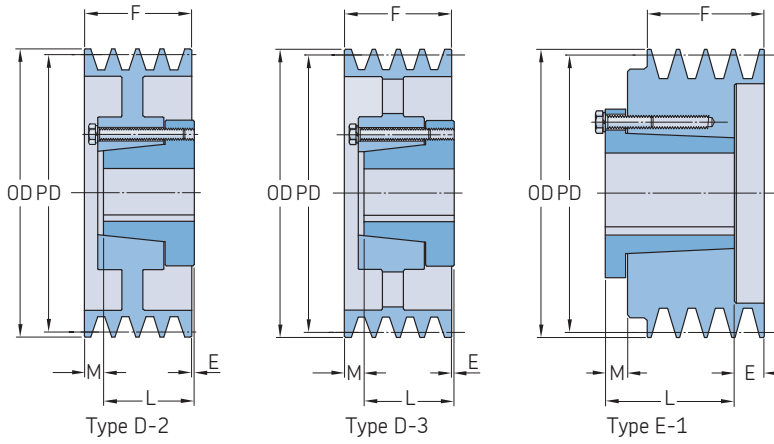

Section	Number of grooves	Pitch diameter PD	Pulley type	Bushing number	Dimensions		Bore Min.	Bore Max.	E	F	L	M	Mass*	Designation		
					Outer diameter OD	in.										
		mm			mm	in.									kg	
3V	3	113,03	A-1	SDS	114,30	4,50	12,70	50,80	0,79	38,10	33,34	4	1,6	PHP 3-3V450-SDS		
		119,38	A-1	SDS	120,65	4,75	12,70	50,80	0,79	38,10	33,34	4	1,8	PHP 3-3V475-SDS		
		125,73	A-1	SDS	127,00	5,00	12,70	50,80	0,79	38,10	33,34	4	2,0	PHP 3-3V500-SDS		
		133,35	A-1	SDS	134,62	5,30	12,70	50,80	0,79	38,10	33,34	4	2,4	PHP 3-3V530-SDS		
		140,97	A-1	SDS	142,24	5,60	12,70	50,80	0,79	38,10	33,34	4	2,7	PHP 3-3V560-SDS		
		151,13	A-2	SDS	152,40	6,00	12,70	50,80	0,79	38,10	33,34	4	3,2	PHP 3-3V600-SDS		
		163,83	A-2	SDS	165,10	6,50	12,70	50,80	0,79	38,10	33,34	4	3,7	PHP 3-3V650-SDS		
		173,99	A-2	SDS	175,26	6,90	12,70	50,80	0,79	38,10	33,34	4	4,0	PHP 3-3V690-SDS		
		201,93	D-2	SK	203,20	8,00	12,70	66,68	13,49	38,10	33,34	2	5,1	PHP 3-3V800-SK		
		267,97	D-3	SK	269,24	10,60	12,70	66,68	13,49	38,10	33,34	2	6,4	PHP 3-3V1060-SK		
		354,33	D-3	SK	355,60	14,00	12,70	66,68	13,49	38,10	33,34	2	9,8	PHP 3-3V1400-SK		
		405,13	D-3	SK	406,40	16,00	12,70	66,68	13,49	38,10	33,34	2	11,4	PHP 3-3V1600-SK		
		481,33	D-3	SF	482,60	19,00	12,70	74,61	15,08	38,10	52,39	1	14,6	PHP 3-3V1900-SF		
		633,73	D-3	SF	635,00	25,00	12,70	74,61	15,08	38,10	52,39	1	22,7	PHP 3-3V2500-SF		
		849,63	D-3	SF	850,90	33,50	22,23	88,90	15,08	38,10	52,39	1	35,4	PHP 3-3V3350-SF		
		3V	4	66,04	D-1	JA	67,31	2,65	12,70	31,75	9,53	48,42	25,40	15	0,6	PHP 4-3V265-JA
				69,85	D-1	JA	71,12	2,80	12,70	31,75	9,53	48,42	25,40	15	0,8	PHP 4-3V280-JA
				74,93	E-1	SH	76,20	3,00	12,70	41,28	12,70	48,42	33,34	23	0,9	PHP 4-3V300-SH
				78,74	E-1	SH	80,01	3,15	12,70	41,28	12,70	48,42	33,34	23	1,0	PHP 4-3V315-SH
				83,82	D-1	SH	85,09	3,35	12,70	41,28	13,49	48,42	33,34	29	1,0	PHP 4-3V335-SH
91,44	D-1			SH	92,71	3,65	12,70	41,28	13,49	48,42	33,34	29	1,3	PHP 4-3V365-SH		
103,38	A-1			SH	104,65	4,12	12,70	41,28	3,97	48,42	33,34	11	1,5	PHP 4-3V412-SH		
113,03	A-1			SDS	114,30	4,50	12,70	50,80	3,97	48,42	33,34	11	1,8	PHP 4-3V450-SDS		
119,38	A-1			SDS	120,65	4,75	12,70	50,80	3,97	48,42	33,34	11	2,1	PHP 4-3V475-SDS		
125,73	A-1			SDS	127,00	5,00	12,70	50,80	3,97	48,42	33,34	11	2,4	PHP 4-3V500-SDS		
133,35	A-1			SDS	134,62	5,30	12,70	50,80	3,97	48,42	33,34	11	2,6	PHP 4-3V530-SDS		
140,97	A-1			SDS	142,24	5,60	12,70	50,80	3,97	48,42	33,34	11	3,1	PHP 4-3V560-SDS		
151,13	D-1			SK	152,40	6,00	12,70	66,68	3,97	48,42	33,34	3	3,8	PHP 4-3V600-SK		
163,83	D-1			SK	165,10	6,50	12,70	66,68	3,97	48,42	33,34	3	4,5	PHP 4-3V650-SK		
173,99	D-1			SK	175,26	6,90	12,70	66,68	3,97	48,42	33,34	3	5,4	PHP 4-3V690-SK		
201,93	D-2			SK	203,20	8,00	12,70	66,68	3,97	48,42	33,34	3	5,9	PHP 4-3V800-SK		
267,97	D-3			SK	269,24	10,60	12,70	66,68	3,97	48,42	33,34	3	7,5	PHP 4-3V1060-SK		
354,33	D-3			SK	355,60	14,00	12,70	66,68	3,97	48,42	33,34	3	10,2	PHP 4-3V1400-SK		
405,13	D-3			SK	406,40	16,00	12,70	66,68	3,97	48,42	33,34	3	12,6	PHP 4-3V1600-SK		
481,33	D-3			SF	482,60	19,00	12,70	74,61	5,56	48,42	52,39	2	15,9	PHP 4-3V1900-SF		
633,73	D-3	SF	635,00	25,00	12,70	74,61	5,56	48,42	52,39	2	25,9	PHP 4-3V2500-SF				
849,63	C-3	E	850,90	33,50	22,23	88,90	16,67	48,42	69,85	5	38,1	PHP 4-3V3350-E				
3V	5	119,38	A-1	SDS	120,65	4,75	12,70	50,80	3,97	58,74	49,21	21	2,3	PHP 5-3V475-SDS		
		125,73	A-1	SDS	127,00	5,00	12,70	50,80	3,97	58,74	49,21	21	2,6	PHP 5-3V500-SDS		
		133,35	A-1	SK	134,62	5,30	12,70	66,68	3,97	58,74	49,21	6	3,0	PHP 5-3V530-SK		
		140,97	A-1	SK	142,24	5,60	12,70	66,68	3,97	58,74	49,21	6	3,4	PHP 5-3V560-SK		
		151,13	A-1	SK	152,40	6,00	12,70	66,68	3,97	58,74	49,21	6	4,0	PHP 5-3V600-SK		
		163,83	A-2	SK	165,10	6,50	12,70	66,68	3,97	58,74	49,21	6	4,8	PHP 5-3V650-SK		
		173,99	A-2	SK	175,26	6,90	12,70	66,68	3,97	58,74	49,21	6	5,8	PHP 5-3V690-SK		
		201,93	A-2	SK	203,20	8,00	12,70	66,68	3,97	58,74	49,21	6	6,3	PHP 5-3V800-SK		
		267,97	A-3	SK	269,24	10,60	12,70	66,68	3,97	58,74	49,21	6	7,7	PHP 5-3V1060-SK		
		354,33	A-3	SF	355,60	14,00	12,70	74,61	0,79	58,74	74,61	6	11,8	PHP 5-3V1400-SF		
		481,33	A-3	SF	482,60	19,00	12,70	74,61	0,79	58,74	74,61	6	18,6	PHP 5-3V1900-SF		
		633,73	D-3	E	635,00	25,00	22,23	88,90	13,49	58,74	69,85	2	28,6	PHP 5-3V2500-E		
		849,63	D-3	E	850,90	33,50	22,23	88,90	13,49	58,74	69,85	2	43,1	PHP 5-3V3350-E		
3V	6	119,38	D-1	SK	120,65	4,75	12,70	66,68	16,67	69,06	49,21	37	2,7	PHP 6-3V475-SK		
		125,73	D-1	SK	127,00	5,00	12,70	66,68	16,67	69,06	49,21	37	2,9	PHP 6-3V500-SK		
		133,35	A-1	SK	134,62	5,30	12,70	66,68	13,49	69,06	49,21	6	3,1	PHP 6-3V530-SK		

* Mass does not include bushings.

Narrow wedge belt pulleys
 3V QD bushed | 5V QD bushed

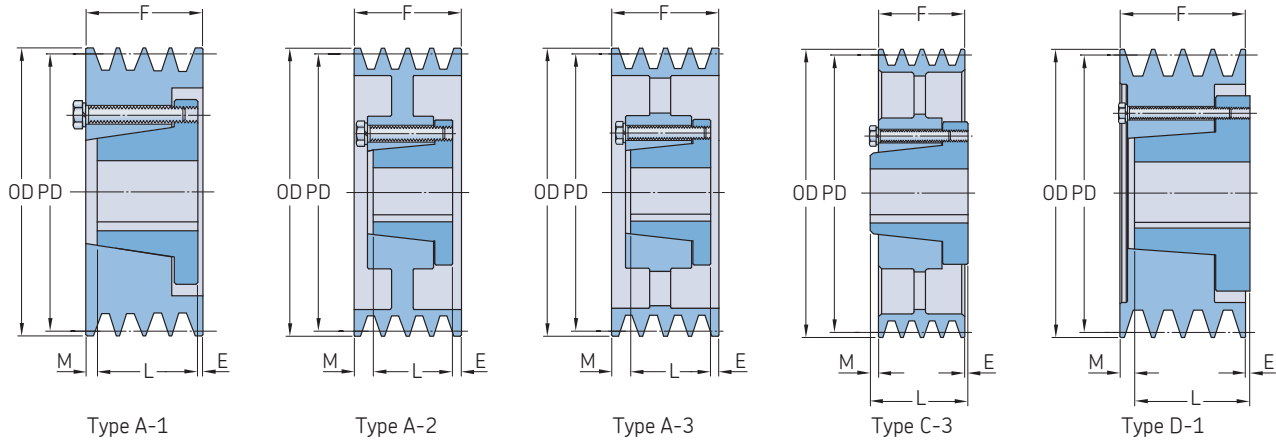

Section	Number of grooves	Pitch diameter PD	Pulley type	Bushing number	Dimensions		Bore		E	F	L	M	Mass*	Designation	
					Outer diameter OD	in.	Min.	Max.							
		mm			mm	in.								kg	
3V	6	140,97	A-1	SK	142,24	5,60	12,70	66,68	13,49	69,06	49,21	6	3,9	PHP 6-3V560-SK	
		151,13	A-1	SK	152,40	6,00	12,70	66,68	13,49	69,06	49,21	6	4,5	PHP 6-3V600-SK	
		163,83	A-1	SK	165,10	6,50	12,70	66,68	13,49	69,06	49,21	6	5,2	PHP 6-3V650-SK	
		173,99	A-1	SK	175,26	6,90	12,70	66,68	13,49	69,06	49,21	6	6,1	PHP 6-3V690-SK	
		201,93	A-2	SK	203,20	8,00	12,70	74,61	2,38	69,06	49,21	17	6,8	PHP 6-3V800-SK	
		267,97	A-3	SF	269,24	10,60	12,70	74,61	0,79	69,06	74,61	16	10,3	PHP 6-3V1060-SF	
	354,33	A-3	SF	355,60	14,00	22,23	88,90	0,79	69,06	74,61	16	13,4	PHP 6-3V1400-SF		
	481,33	D-3	E	482,60	19,00	22,23	88,90	3,97	69,06	69,85	3	20,0	PHP 6-3V1900-E		
	633,73	D-3	E	635,00	25,00	22,23	88,90	3,97	69,06	69,85	3	29,5	PHP 6-3V2500-E		
	849,63	D-3	E	850,90	33,50	22,23	88,90	3,97	69,06	69,85	3	45,8	PHP 6-3V3500-E		
	3V	8	119,38	D-1	SK	120,65	4,75	12,70	66,68	16,67	89,69	49,21	57	3,3	PHP 8-3V475-SK
			125,73	D-1	SK	127,00	5,00	12,70	66,68	16,67	89,69	49,21	57	3,5	PHP 8-3V500-SK
			133,35	A-1	SK	134,62	5,30	12,70	66,68	13,49	89,69	49,21	27	4,2	PHP 8-3V530-SK
			140,97	A-1	SK	142,24	5,60	12,70	66,68	13,49	89,69	49,21	27	4,8	PHP 8-3V560-SK
			151,13	A-1	SK	152,40	6,00	12,70	66,68	13,49	89,69	49,21	27	5,7	PHP 8-3V600-SK
			163,83	A-1	SK	165,10	6,50	12,70	66,68	13,49	89,69	49,21	27	7,3	PHP 8-3V650-SK
		173,99	A-1	SK	175,26	6,90	12,70	66,68	13,49	89,69	49,21	27	8,2	PHP 8-3V690-SK	
		201,93	A-1	SF	203,20	8,00	12,70	74,61	7,14	89,69	74,61	21	9,5	PHP 8-3V800-SF	
267,97		A-2	SF	269,24	10,60	12,70	74,61	7,14	89,69	74,61	21	11,6	PHP 8-3V1060-SF		
354,33		A-3	E	355,60	14,00	22,23	88,90	2,38	89,69	69,85	17	17,5	PHP 8-3V1400-E		
481,33		A-3	E	482,60	19,00	22,23	88,90	2,38	89,69	69,85	17	24,5	PHP 8-3V1900-E		
633,73		A-3	E	635,00	25,00	22,23	88,90	2,38	89,69	69,85	17	36,3	PHP 8-3V2500-E		
849,63	D-3	F	850,90	33,50	25,40	101,60	7,14	89,69	95,25	17	14,5	PHP 8-3V3500-F			
3V	10	119,38	D-1	SK	120,65	4,75	12,70	66,68	16,67	110,33	49,21	78	3,8	PHP 10-3V475-SK	
		125,73	D-1	SK	127,00	5,00	12,70	66,68	16,67	110,33	49,21	78	4,3	PHP 10-3V500-SK	
		133,35	A-1	SK	134,62	5,30	12,70	66,68	16,67	110,33	49,21	44	4,6	PHP 10-3V530-SK	
		140,97	A-1	SK	142,24	5,60	12,70	66,68	16,67	110,33	49,21	44	5,2	PHP 10-3V560-SK	
		151,13	A-1	SK	152,40	6,00	12,70	66,68	16,67	110,33	49,21	44	6,6	PHP 10-3V600-SK	
		163,83	A-1	SK	165,10	6,50	12,70	66,68	16,67	110,33	49,21	44	7,9	PHP 10-3V650-SK	
	173,99	A-1	SK	175,26	6,90	12,70	66,68	16,67	110,33	49,21	44	9,1	PHP 10-3V690-SK		
	201,93	A-1	SF	203,20	8,00	12,70	74,61	16,67	110,33	52,39	41	10,9	PHP 10-3V800-SF		
	267,97	A-2	E	269,24	10,60	22,23	88,90	2,38	110,33	52,39	38	13,7	PHP 10-3V1060-E		
	354,33	A-3	E	355,60	14,00	22,23	88,90	2,38	110,33	52,39	38	19,4	PHP 10-3V1400-E		
	481,33	A-3	E	482,60	19,00	22,23	88,90	2,38	110,33	52,39	38	29,0	PHP 10-3V1900-E		
	633,73	D-3	F	635,00	25,00	25,40	101,60	0,79	110,33	95,25	16	44,9	PHP 10-3V2500-F		
849,63	D-3	F	850,90	33,50	25,40	101,60	0,79	110,33	120,65	16	71,7	PHP 10-3V3500-F			
5V	2	109,22	D-1	SH	111,76	4,40	12,70	41,28	8,73	42,86	33,34	18	2,6	PHP 2-5V440-SH	
		115,57	E-1	SDS	118,11	4,65	12,70	50,80	21,43	42,86	33,34	12	3,0	PHP 2-5V465-SDS	
		121,92	A-1	SDS	124,46	4,90	12,70	50,80	0,79	42,86	33,34	9	3,1	PHP 2-5V490-SDS	
		129,54	A-1	SDS	132,08	5,20	12,70	50,80	0,79	42,86	33,34	9	3,2	PHP 2-5V520-SDS	
		137,16	A-1	SDS	139,70	5,50	12,70	50,80	0,79	42,86	33,34	9	3,3	PHP 2-5V550-SDS	
		147,32	A-1	SDS	149,86	5,90	12,70	50,80	0,79	42,86	33,34	9	3,5	PHP 2-5V590-SDS	
	157,48	D-1	SK	160,02	6,30	12,70	66,68	8,73	42,86	49,21	2	4,3	PHP 2-5V630-SK		
	167,64	D-1	SK	170,18	6,70	12,70	66,68	8,73	42,86	49,21	2	4,8	PHP 2-5V670-SK		
	177,80	D-1	SK	180,34	7,10	12,70	66,68	8,73	42,86	49,21	2	5,2	PHP 2-5V710-SK		
	187,96	D-1	SK	190,50	7,50	12,70	66,68	8,73	42,86	49,21	2	5,7	PHP 2-5V750-SK		
	200,66	D-2	SK	203,20	8,00	12,70	66,68	8,73	42,86	49,21	2	5,9	PHP 2-5V800-SK		
	213,36	D-2	SK	215,90	8,50	12,70	66,68	8,73	42,86	49,21	2	6,4	PHP 2-5V850-SK		
	226,06	D-3	SK	228,60	9,00	12,70	66,68	8,73	42,86	33,34	2	6,9	PHP 2-5V900-SK		
	232,41	D-3	SK	234,95	9,25	12,70	66,68	8,73	42,86	33,34	2	6,9	PHP 2-5V925-SK		
	245,11	D-3	SK	247,65	9,75	12,70	66,68	8,73	42,86	49,21	2	7,0	PHP 2-5V975-SK		
	259,08	D-3	SK	261,62	10,30	12,70	66,68	8,73	42,86	49,21	2	7,0	PHP 2-5V1030-SK		
	274,32	D-3	SK	276,86	10,90	12,70	66,68	8,73	42,86	49,21	2	7,5	PHP 2-5V1090-SK		

* Mass does not include bushings.

Narrow wedge belt pulleys

5V QD bushed

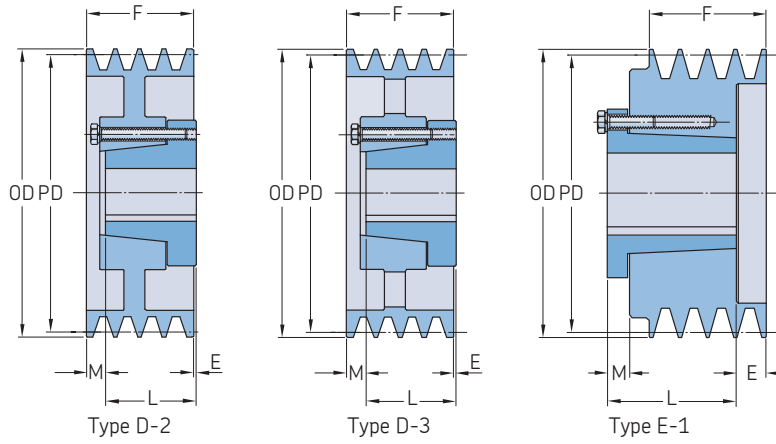

Section	Number of grooves	Pitch diameter PD	Pulley type	Bushing number	Dimensions		Bore Min.	Bore Max.	E	F	L	M	Mass*	Designation		
					Outer diameter OD	in.										
—	—	mm	—	—	mm	in.	—	—	—	—	—	—	kg	—		
5V	2	284,48	D-3	SK	287,02	11,30	12,70	66,68	8,73	42,86	49,21	2	8,1	PHP 2-5V1130-SK		
		297,18	D-3	SK	299,72	11,80	12,70	66,68	8,73	42,86	49,21	2	8,6	PHP 2-5V1180-SK		
		314,96	D-3	SF	317,50	12,50	12,70	74,61	10,32	42,86	52,39	1	9,5	PHP 2-5V1250-SF		
		332,74	D-3	SF	335,28	13,20	12,70	74,61	10,32	42,86	52,39	1	10,3	PHP 2-5V1320-SF		
		353,06	D-3	SF	355,60	14,00	12,70	74,61	10,32	42,86	52,39	1	11,5	PHP 2-5V1400-SF		
		378,46	D-3	SF	381,00	15,00	12,70	74,61	10,32	42,86	52,39	1	12,4	PHP 2-5V1500-SF		
	5V	3	403,86	D-3	SF	406,40	16,00	12,70	74,61	10,32	42,86	52,39	1	13,2	PHP 2-5V1600-SF	
			472,44	D-3	SF	474,98	18,70	12,70	74,61	10,32	42,86	52,39	1	16,3	PHP 2-5V1870-SF	
			535,94	D-3	SF	538,48	21,20	12,70	74,61	10,32	42,86	26,99	1	19,5	PHP 2-5V2120-SF	
			596,90	C-3	E	599,44	23,60	22,23	88,90	23,02	42,86	69,85	4	25,0	PHP 2-5V2360-E	
			708,66	C-3	E	711,20	28,00	22,23	88,90	23,02	42,86	69,85	4	30,4	PHP 2-5V2800-E	
			109,22	E-1	SDS	111,76	4,40	12,70	50,80	43,66	60,33	33,34	17	3,0	PHP 3-5V440-SDS	
		5V	4	115,57	E-1	SDS	118,11	4,65	12,70	50,80	43,66	60,33	33,34	17	3,5	PHP 3-5V465-SDS
				121,92	A-1	SDS	124,46	4,90	12,70	50,80	10,32	60,33	33,34	17	3,5	PHP 3-5V490-SDS
				129,54	A-1	SDS	132,08	5,20	12,70	50,80	10,32	60,33	33,34	17	3,6	PHP 3-5V520-SDS
				137,16	A-1	SDS	139,70	5,50	12,70	50,80	10,32	60,33	33,34	17	3,7	PHP 3-5V550-SDS
147,32				A-1	SDS	149,86	5,90	12,70	50,80	10,32	60,33	33,34	17	3,9	PHP 3-5V590-SDS	
157,48				A-1	SK	160,02	6,30	12,70	66,68	7,14	60,33	49,21	4	4,7	PHP 3-5V630-SK	
5V			5	167,64	A-1	SK	170,18	6,70	12,70	66,68	7,14	60,33	49,21	4	5,3	PHP 3-5V670-SK
				177,80	A-1	SF	180,34	7,10	12,70	74,61	3,97	60,33	52,39	4	5,8	PHP 3-5V710-SF
				187,96	A-1	SF	190,50	7,50	12,70	74,61	3,97	60,33	52,39	4	6,8	PHP 3-5V750-SF
				200,66	A-1	SF	203,20	8,00	12,70	74,61	3,97	60,33	52,39	4	7,5	PHP 3-5V800-SF
	213,36			A-3	SF	215,90	8,50	12,70	74,61	3,97	60,33	52,39	4	8,2	PHP 3-5V850-SF	
	226,06			A-3	SF	228,60	9,00	12,70	74,61	3,97	60,33	52,39	4	9,0	PHP 3-5V900-SF	
	5V		6	232,41	A-3	SF	234,95	9,25	12,70	74,61	3,97	60,33	52,39	4	9,4	PHP 3-5V925-SF
				245,11	A-3	SF	247,65	9,75	12,70	74,61	3,97	60,33	52,39	4	10,3	PHP 3-5V975-SF
				259,08	A-3	SF	261,62	10,30	12,70	74,61	3,97	60,33	52,39	4	11,2	PHP 3-5V1030-SF
				274,32	A-3	SF	276,86	10,90	12,70	74,61	3,97	60,33	52,39	4	12,1	PHP 3-5V1090-SF
		284,48		A-3	SF	287,02	11,30	12,70	74,61	3,97	60,33	52,39	4	12,8	PHP 3-5V1130-SF	
		297,18		D-3	SF	299,72	11,80	12,70	74,61	3,97	60,33	52,39	4	13,5	PHP 3-5V1180-SF	
		5V	7	314,96	D-3	E	317,50	12,50	22,23	88,90	10,32	60,33	69,85	1	15,4	PHP 3-5V1250-E
				332,74	D-3	E	335,28	13,20	22,23	88,90	10,32	60,33	69,85	1	15,9	PHP 3-5V1320-E
				353,06	D-3	E	355,60	14,00	22,23	88,90	10,32	60,33	69,85	1	16,8	PHP 3-5V1400-E
				378,46	D-3	E	381,00	15,00	22,23	88,90	10,32	60,33	69,85	1	17,2	PHP 3-5V1500-E
403,86				D-3	E	406,40	16,00	22,23	88,90	10,32	60,33	69,85	1	17,8	PHP 3-5V1600-E	
472,44				D-3	E	474,98	18,70	22,23	88,90	10,32	60,33	69,85	1	21,4	PHP 3-5V1870-E	
5V			8	535,94	D-3	E	538,48	21,20	22,23	88,90	10,32	60,33	69,85	1	25,0	PHP 3-5V2120-E
				596,90	D-3	E	599,44	23,60	22,23	88,90	10,32	60,33	69,85	1	31,8	PHP 3-5V2360-E
				708,66	D-3	E	711,20	28,00	22,23	88,90	10,32	60,33	69,85	1	39,2	PHP 3-5V2800-E
				797,56	C-3	F	800,10	31,50	25,40	101,60	19,84	60,33	95,25	15	52,6	PHP 3-5V3150-F
	949,96			C-3	F	952,50	37,50	25,40	101,60	19,84	60,33	95,25	15	64,0	PHP 3-5V3750-F	
	1267,46			C-3	F	1270,00	50,00	25,40	101,60	19,84	60,33	95,25	15	95,7	PHP 3-5V5000-F	
	5V		9	109,22	E-1	SD	111,76	4,40	12,70	50,80	48,42	77,79	46,04	17	3,4	PHP 4-5V440-SD
				115,57	E-1	SD	118,11	4,65	12,70	50,80	48,42	77,79	46,04	17	3,6	PHP 4-5V465-SD
				121,92	A-1	SD	124,46	4,90	12,70	50,80	16,67	77,79	46,04	15	3,9	PHP 4-5V490-SD
				129,54	A-1	SD	132,08	5,20	12,70	50,80	16,67	77,79	46,04	15	4,0	PHP 4-5V520-SD
		137,16		A-1	SD	139,70	5,50	12,70	50,80	16,67	77,79	46,04	15	4,2	PHP 4-5V550-SD	
		147,32		A-1	SD	149,86	5,90	12,70	50,80	16,67	77,79	46,04	15	4,6	PHP 4-5V590-SD	
		5V	10	157,48	A-1	SK	160,02	6,30	12,70	66,68	13,49	77,79	49,21	15	5,4	PHP 4-5V630-SK
				167,64	A-1	SK	170,18	6,70	12,70	66,68	13,49	77,79	49,21	15	6,2	PHP 4-5V670-SK
				177,80	A-1	SF	180,34	7,10	12,70	74,61	5,56	77,79	52,39	20	6,8	PHP 4-5V710-SF
				187,96	A-1	SF	190,50	7,50	12,70	74,61	5,56	77,79	52,39	20	7,7	PHP 4-5V750-SF
200,66				A-1	SF	203,20	8,00	12,70	74,61	5,56	77,79	52,39	20	8,6	PHP 4-5V800-SF	
213,36				A-1	SF	215,90	8,50	12,70	74,61	5,56	77,79	52,39	20	9,5	PHP 4-5V850-SF	
5V			11	226,06	A-1	SF	228,60	9,00	12,70	74,61	5,56	77,79	52,39	20	10,4	PHP 4-5V900-SF
				232,41	A-1	SF	234,95	9,25	12,70	74,61	5,56	77,79	52,39	20	11,3	PHP 4-5V925-SF
				245,11	A-1	SF	247,65	9,75	12,70	74,61	5,56	77,79	52,39	20	12,2	PHP 4-5V975-SF
				259,08	A-1	SF	261,62	10,30	12,70	74,61	5,56	77,79	52,39	20	13,1	PHP 4-5V1030-SF

* Mass does not include bushings.

Narrow wedge belt pulleys

5V QD bushed

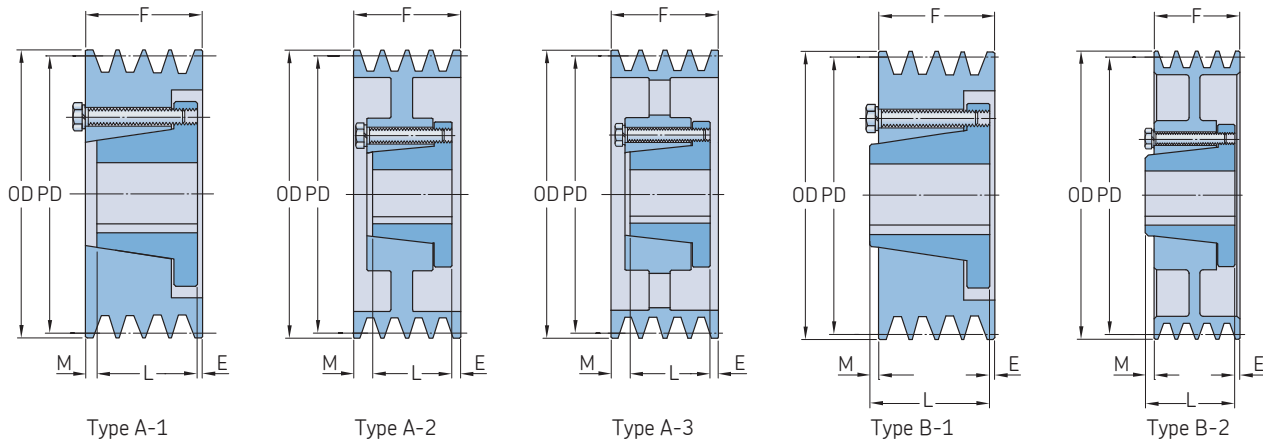

Section	Number of grooves	Pitch diameter PD	Pulley type	Bushing number	Dimensions		Bore		E	F	L	M	Mass*	Designation
					Outer diameter OD	in.	Min.	Max.						
5V	4	200,66 213,36 226,06 232,41 245,11	B-1 B-1 B-1 B-1	E E E E	203,20 215,90 228,60 234,95 247,65	8,00 8,50 9,00 9,25 9,75	22,23 22,23 22,23 22,23	88,90 88,90 88,90 88,90	8,73 8,73 8,73 8,73	77,79 77,79 77,79 77,79	69,85 69,85 69,85 69,85	1 1 1 1	8,5 9,9 11,0 11,7 12,8	PHP 4-5V800-E PHP 4-5V850-E PHP 4-5V900-E PHP 4-5V925-E PHP 4-5V975-E
		259,08 274,32 284,48 297,18 314,96	B-1 B-2 A-3 B-2 A-3	E E E E E	261,62 276,86 287,02 299,72 317,50	10,30 10,90 11,30 11,80 12,50	22,23 22,23 22,23 22,23	88,90 88,90 88,90 88,90	8,73 8,73 7,14 8,73 7,14	77,79 77,79 77,79 77,79	69,85 69,85 69,85 69,85	1 1 1 1 1	13,5 13,9 14,5 15,0 16,5	PHP 4-5V1030-E PHP 4-5V1090-E PHP 4-5V1130-E PHP 4-5V1180-E PHP 4-5V1250-E
		332,74 353,06 378,46 403,86 472,44	A-3 A-3 A-3 A-3 A-3	E E E E E	335,28 355,60 381,00 406,40 474,98	13,20 14,00 15,00 16,00 18,70	22,23 22,23 22,23 22,23	88,90 88,90 88,90 88,90	7,14 7,14 7,14 7,14 2,38	77,79 77,79 77,79 77,79	69,85 69,85 69,85 69,85	1 1 1 1 1	17,3 18,2 19,7 20,2 24,3	PHP 4-5V1320-E PHP 4-5V1400-E PHP 4-5V1500-E PHP 4-5V1600-E PHP 4-5V1870-E
		535,94 596,90 708,66 797,56 949,96	A-3 C-3 C-3 C-3 C-3	E F F F F	538,48 599,44 711,20 800,10 952,50	21,20 23,60 28,00 31,50 37,50	22,23 25,40 25,40 25,40	88,90 101,60 101,60 101,60	2,38 11,91 11,91 11,91	77,79 77,79 77,79 77,79	69,85 95,25 95,25 95,25	1 6 6 6 6	28,4 37,9 57,2 67,1 77,1	PHP 4-5V2120-E PHP 4-5V2360-F PHP 4-5V2800-F PHP 4-5V3150-F PHP 4-5V3750-F
		1267,46	C-3	J	1270,00	50,00	38,10	114,30	19,05	77,79	117,48	21	112,5	PHP 4-5V5000-J
5V	5	109,22 115,57 121,92 129,54 137,16	E-1 E-1 A-1 A-1 A-1	SD SD SD SD SD	111,76 118,11 124,46 132,08 139,70	4,40 4,65 4,90 5,20 5,50	12,70 12,70 12,70 12,70	50,80 50,80 50,80 50,80	65,88 65,88 16,67 16,67	95,25 95,25 95,25 95,25	46,04 46,04 46,04 46,04	17 17 15 15	4,0 4,2 4,6 4,9	PHP 5-5V440-SD PHP 5-5V465-SD PHP 5-5V490-SD PHP 5-5V520-SD PHP 5-5V550-SD
		147,32 157,48 167,64 177,80 187,96	A-1 A-1 A-1 A-1 A-1	SK SK SF SF SF	149,86 160,02 170,18 180,34 190,50	5,90 6,30 6,70 7,10 7,50	12,70 12,70 12,70 12,70	66,68 66,68 74,61 74,61	13,49 13,49 13,49 13,49	95,25 95,25 95,25 95,25	49,21 49,21 52,39 52,39	12 12 12 10	6,0 7,2 8,4 9,8 10,3	PHP 5-5V590-SK PHP 5-5V630-SK PHP 5-5V670-SF PHP 5-5V710-SF PHP 5-5V750-SF
		200,66 213,36 226,06 232,41 245,11	A-1 A-1 A-1 A-1 A-1	E E E E E	203,20 215,90 228,60 234,95 247,65	8,00 8,50 9,00 9,25 9,75	22,23 22,23 22,23	88,90 88,90 88,90	15,08 15,08 15,08	95,25 95,25 95,25	69,85 69,85 69,85	10 10 10	10,8 11,3 11,9 12,8 14,5	PHP 5-5V800-E PHP 5-5V850-E PHP 5-5V900-E PHP 5-5V925-E PHP 5-5V975-E
		259,08 274,32 284,48 297,18 314,96	A-2 A-2 A-3 A-3 A-3	E E E E E	261,62 276,86 287,02 299,72 317,50	10,30 10,90 11,30 11,80 12,50	22,23 22,23 22,23	88,90 88,90 88,90	15,08 15,08 15,08	95,25 95,25 95,25	69,85 69,85 69,85	10 10 10	15,0 15,9 16,6 17,2 18,5	PHP 5-5V1030-E PHP 5-5V1090-E PHP 5-5V1130-E PHP 5-5V1180-E PHP 5-5V1250-E
		332,74 353,06 378,46 403,86 472,44	A-3 A-3 A-3 A-3 D-3	E E E E F	335,28 355,60 381,00 406,40 474,98	13,20 14,00 15,00 16,00 18,70	22,23 22,23 22,23	88,90 88,90 88,90	15,08 15,08 15,08	95,25 95,25 95,25	69,85 69,85 69,85	10 10 10	19,2 20,2 21,9 23,2 31,8	PHP 5-5V1320-E PHP 5-5V1400-E PHP 5-5V1500-E PHP 5-5V1600-E PHP 5-5V1870-F
		535,94 596,90 708,66 797,56 949,96	D-3 D-3 D-3 C-3 C-3	F F F J J	538,48 599,44 711,20 800,10 952,50	21,20 23,60 28,00 31,50 37,50	25,40 25,40 25,40 38,10 38,10	101,60 101,60 101,60	0,79 0,79 0,79	95,25 95,25 95,25	95,25 95,25 95,25	1 1 1	40,4 47,6 55,8	PHP 5-5V2120-F PHP 5-5V2360-F PHP 5-5V2800-F
		949,96	C-3	J	952,50	37,50	38,10	114,30	11,11	95,25	117,48	11	86,2	PHP 5-5V3150-J PHP 5-5V3750-J
		1267,46	C-3	J	1270,00	50,00	38,10	114,30	11,11	95,25	117,48	11	126,1	PHP 5-5V5000-J

* Mass does not include bushings.

Narrow wedge belt pulleys

5V QD bushed

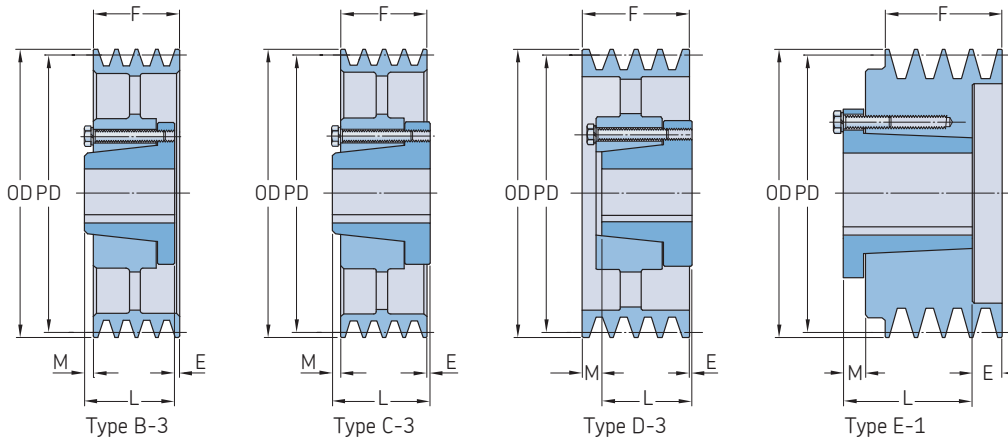

Section	Number of grooves	Pitch diameter	Pulley type	Bushing number	Dimensions		Bore Min.	Max.	E	F	L	M	Mass*	Designation
		PD			Outer diameter OD	in.								
		mm			mm	in.							kg	
5V	6	109,22	E-1	SD	111,76	4,40	12,70	50,80	96,04	112,71	46,04	17	4,6	PHP 6-5V440-SD
		115,57	E-1	SD	118,11	4,65	12,70	50,80	96,04	112,71	46,04	17	4,7	PHP 6-5V465-SD
		121,92	A-1	SD	124,46	4,90	12,70	50,80	16,67	112,71	46,04	50	5,1	PHP 6-5V490-SD
		129,54	A-1	SD	132,08	5,20	12,70	50,80	16,67	112,71	46,04	50	5,5	PHP 6-5V520-SD
		137,16	A-1	SD	139,70	5,50	12,70	50,80	16,67	112,71	46,04	50	6,0	PHP 6-5V550-SD
		147,32	A-1	SK	149,86	5,90	12,70	66,68	13,49	112,71	49,21	50	6,6	PHP 6-5V590-SK
		157,48	A-1	SK	160,02	6,30	12,70	66,68	13,49	112,71	49,21	50	7,9	PHP 6-5V630-SK
		167,64	A-1	SF	170,18	6,70	12,70	74,61	19,84	112,71	52,39	40	9,1	PHP 6-5V670-SF
		177,80	A-1	SF	180,34	7,10	12,70	74,61	19,84	112,71	52,39	40	9,9	PHP 6-5V710-SF
		187,96	A-1	SF	190,50	7,50	12,70	74,61	19,84	112,71	52,39	40	10,6	PHP 6-5V750-SF
		200,66	A-1	E	203,20	8,00	22,23	88,90	21,43	112,71	69,85	21	11,0	PHP 6-5V800-E
		213,36	A-1	E	215,90	8,50	22,23	88,90	21,43	112,71	69,85	21	12,1	PHP 6-5V850-E
		226,06	A-1	E	228,60	9,00	22,23	88,90	21,43	112,71	69,85	21	12,9	PHP 6-5V900-E
		232,41	A-1	E	234,95	9,25	22,23	88,90	21,43	112,71	69,85	21	13,7	PHP 6-5V925-E
		245,11	A-1	E	247,65	9,75	22,23	88,90	21,43	112,71	69,85	21	15,3	PHP 6-5V975-E
		259,08	A-2	E	261,62	10,30	22,23	88,90	21,43	112,71	69,85	21	16,6	PHP 6-5V1030-E
		274,32	A-2	E	276,86	10,90	22,23	88,90	21,43	112,71	69,85	21	17,3	PHP 6-5V1090-E
		284,48	A-3	E	287,02	11,30	22,23	88,90	21,43	112,71	69,85	21	18,1	PHP 6-5V1130-E
		297,18	A-2	E	299,72	11,80	22,23	88,90	21,43	112,71	69,85	21	18,7	PHP 6-5V1180-E
		314,96	B-3	F	317,50	12,50	25,40	101,60	18,26	112,71	95,25	1	26,4	PHP 6-5V1250-F
		332,74	B-3	F	335,28	13,20	25,40	101,60	18,26	112,71	95,25	1	29,0	PHP 6-5V1320-F
		353,06	B-3	F	355,60	14,00	25,40	101,60	18,26	112,71	95,25	1	29,9	PHP 6-5V1400-F
		378,46	B-3	F	381,00	15,00	25,40	101,60	18,26	112,71	95,25	1	30,8	PHP 6-5V1500-F
		403,86	B-3	F	406,40	16,00	25,40	101,60	18,26	112,71	95,25	1	35,2	PHP 6-5V1600-F
		472,44	D-3	F	474,98	18,70	25,40	101,60	0,79	112,71	95,25	18	38,9	PHP 6-5V1870-F
		535,94	D-3	F	538,48	21,20	25,40	101,60	0,79	112,71	95,25	18	43,5	PHP 6-5V2120-F
		596,90	C-3	J	599,44	23,60	38,10	114,30	3,18	112,71	117,48	2	51,3	PHP 6-5V2360-J
		708,66	C-3	J	711,20	28,00	38,10	114,30	3,18	112,71	117,48	2	67,1	PHP 6-5V2800-J
		797,56	C-3	J	800,10	31,50	38,10	114,30	3,18	112,71	117,48	2	83,0	PHP 6-5V3150-J
		949,96	C-3	J	952,50	37,50	38,10	114,30	3,18	112,71	117,48	2	98,9	PHP 6-5V3750-J
		1267,46	C-3	M	1270,00	50,00	50,80	139,70	27,78	112,71	171,45	31	140,6	PHP 6-5V5000-M
5V	8	177,80	A-1	SF	180,34	7,10	12,70	74,61	32,54	147,64	52,39	63	11,2	PHP 8-5V710-SF
		187,96	A-1	SF	190,50	7,50	12,70	74,61	32,54	147,64	52,39	63	12,8	PHP 8-5V750-SF
		200,66	A-1	E	203,20	8,00	22,23	63,50	34,13	147,64	69,85	44	15,9	PHP 8-5V800-E
		213,36	A-1	E	215,90	8,50	22,23	63,50	34,13	147,64	69,85	44	16,9	PHP 8-5V850-E
		226,06	A-1	E	228,60	9,00	22,23	63,50	34,13	147,64	69,85	44	19,1	PHP 8-5V900-E
		232,41	A-1	F	234,95	9,25	25,40	101,60	30,96	147,64	95,25	21	20,0	PHP 8-5V925-F
		245,11	A-1	F	247,65	9,75	25,40	101,60	30,96	147,64	95,25	21	22,0	PHP 8-5V975-F
		259,08	A-1	F	261,62	10,30	25,40	101,60	30,96	147,64	95,25	21	26,5	PHP 8-5V1030-F
		274,32	A-1	F	276,86	10,90	25,40	101,60	30,96	147,64	95,25	21	28,6	PHP 8-5V1090-F
		284,48	A-1	F	287,02	11,30	25,40	101,60	30,96	147,64	95,25	21	30,4	PHP 8-5V1130-F
		297,18	A-2	F	299,72	11,80	25,40	101,60	30,96	147,64	95,25	21	32,2	PHP 8-5V1180-F
		314,96	A-3	F	317,50	12,50	25,40	101,60	30,96	147,64	95,25	21	34,5	PHP 8-5V1250-F
		332,74	A-3	F	335,28	13,20	25,40	101,60	30,96	147,64	95,25	21	36,3	PHP 8-5V1320-F
		353,06	A-3	F	355,60	14,00	25,40	101,60	30,96	147,64	95,25	21	36,7	PHP 8-5V1400-F
		378,46	A-3	F	381,00	15,00	25,40	101,60	30,96	147,64	95,25	21	37,7	PHP 8-5V1500-F
		403,86	A-3	F	406,40	16,00	25,40	101,60	30,96	147,64	95,25	21	40,8	PHP 8-5V1600-F
		472,44	A-3	J	474,98	18,70	38,10	114,30	3,18	147,64	117,48	27	54,4	PHP 8-5V1870-J
		535,94	A-3	J	538,48	21,20	38,10	114,30	3,18	147,64	117,48	27	69,0	PHP 8-5V2120-J
		596,90	A-3	J	599,44	23,60	38,10	114,30	3,18	147,64	117,48	27	83,9	PHP 8-5V2360-J
		708,66	A-3	J	711,20	28,00	38,10	114,30	3,18	147,64	117,48	27	95,3	PHP 8-5V2800-J
		797,56	B-3	M	800,10	31,50	50,80	139,70	8,73	147,64	171,45	33	109,8	PHP 8-5V3150-M
		949,96	B-3	M	952,50	37,50	50,80	139,70	8,73	147,64	171,45	33	129,3	PHP 8-5V3750-M

* Mass does not include bushings.

Narrow wedge belt pulleys
5V QD bushed | 8V QD bushed

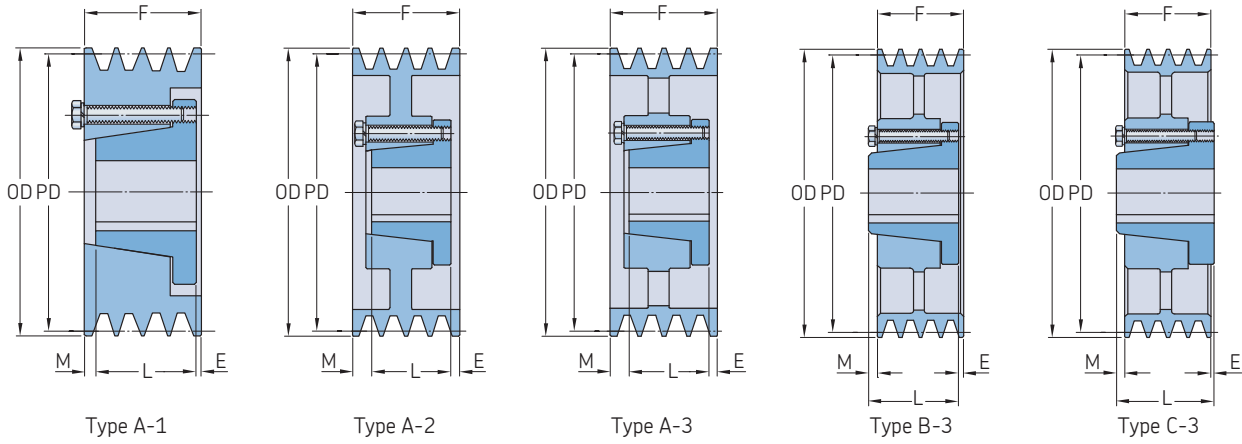

Section	Number of grooves	Pitch diameter PD	Pulley type	Bushing number	Dimensions		Bore		E	F	L	M	Mass*	Designation
					Outer diameter OD	in.	Min.	Max.						
-	-	mm	-	-	mm	in.							kg	-
5V	10	200,66	A-1	E	203,20	8,00	22,23	88,90	53,18	182,56	69,85	60	17,1	PHP 10-5V800-E
		213,36	A-1	F	215,90	8,50	22,23	88,90	53,18	182,56	69,85	60	20,2	PHP 10-5V850-E
		226,06	A-1	F	228,60	9,00	25,40	101,60	50,01	182,56	95,25	37	23,3	PHP 10-5V900-F
		232,41	A-1	F	234,95	9,25	25,40	101,60	50,01	182,56	95,25	37	24,0	PHP 10-5V925-F
		245,11	A-1	F	247,65	9,75	25,40	101,60	50,01	182,56	95,25	37	25,4	PHP 10-5V975-F
		259,08	A-1	F	261,62	10,30	25,40	101,60	50,01	182,56	95,25	37	29,0	PHP 10-5V1030-F
		274,32	A-1	F	276,86	10,90	25,40	101,60	50,01	182,56	95,25	37	32,7	PHP 10-5V1090-F
		284,48	A-1	F	287,02	11,30	25,40	101,60	50,01	182,56	95,25	37	34,9	PHP 10-5V1130-F
		297,18	A-2	F	299,72	11,80	25,40	101,60	50,01	182,56	95,25	37	36,7	PHP 10-5V1180-F
		314,96	A-2	J	317,50	12,50	38,10	114,30	53,98	182,56	117,48	11	50,8	PHP 10-5V1250-J
		332,74	A-2	J	335,28	13,20	38,10	114,30	53,98	182,56	117,48	11	52,6	PHP 10-5V1320-J
		353,06	A-3	J	355,60	14,00	38,10	114,30	53,98	182,56	117,48	11	59,0	PHP 10-5V1400-J
		378,46	A-3	J	381,00	15,00	38,10	114,30	53,98	182,56	117,48	11	62,6	PHP 10-5V1500-J
		403,86	A-3	J	406,40	16,00	38,10	114,30	53,98	182,56	117,48	11	66,2	PHP 10-5V1600-J
		472,44	A-3	J	474,98	18,70	38,10	114,30	3,18	182,56	117,48	62	71,2	PHP 10-5V1870-J
		535,94	A-3	J	538,48	21,20	38,10	114,30	3,18	182,56	117,48	62	76,2	PHP 10-5V2120-J
		596,90	A-3	M	599,44	23,60	50,80	139,70	8,73	182,56	171,45	2	96,6	PHP 10-5V2360-M
		708,66	A-3	M	711,20	28,00	50,80	139,70	8,73	182,56	171,45	2	108,9	PHP 10-5V2800-M
		797,56	A-3	M	800,10	31,50	50,80	139,70	8,73	182,56	171,45	2	124,7	PHP 10-5V3150-M
		949,96	A-3	M	952,50	37,50	50,80	139,70	8,73	182,56	171,45	2	142,9	PHP 10-5V3750-M
		1267,46	A-3	M	1270,00	50,00	50,80	139,70	8,73	182,56	171,45	2	207,8	PHP 10-5V5000-M
		8V	4	312,42	D-2	F	317,50	12,50	25,40	101,60	3,97	123,83	95,25	33
330,20	D-2			F	335,28	13,20	25,40	101,60	3,97	123,83	95,25	33	36,7	PHP 4-8V1320-F
350,52	D-3			F	355,60	14,00	25,40	101,60	3,97	123,83	95,25	33	39,5	PHP 4-8V1400-F
375,92	D-3			F	381,00	15,00	25,40	101,60	3,97	123,83	95,25	33	41,3	PHP 4-8V1500-F
401,32	D-3			F	406,40	16,00	25,40	101,60	3,97	123,83	95,25	33	43,5	PHP 4-8V1600-F
426,72	D-3			F	431,80	17,00	25,40	101,60	3,97	123,83	95,25	33	47,2	PHP 4-8V1700-F
452,12	D-3			F	457,20	18,00	25,40	101,60	3,97	123,83	95,25	33	51,7	PHP 4-8V1800-F
477,52	D-3			F	482,60	19,00	25,40	101,60	3,97	123,83	95,25	33	54,9	PHP 4-8V1900-F
502,92	D-3			J	508,00	20,00	38,10	114,30	-	123,83	117,48	6	61,7	PHP 4-8V2000-J
533,40	D-3			J	538,48	21,20	38,10	114,30	-	123,83	117,48	6	65,8	PHP 4-8V2120-J
563,88	D-3			J	568,96	22,40	38,10	114,30	-	123,83	117,48	6	69,9	PHP 4-8V2240-J
624,84	C-3			M	629,92	24,80	50,80	139,70	19,84	123,83	171,45	28	79,8	PHP 4-8V2480-M
756,92	C-3			M	762,00	30,00	50,80	139,70	19,84	123,83	171,45	28	101,6	PHP 4-8V3000-M
896,62	C-3			M	901,70	35,50	50,80	139,70	19,84	123,83	171,45	28	121,1	PHP 4-8V3550-M
1010,92	C-3			M	1016,00	40,00	50,80	139,70	19,84	123,83	171,45	28	140,6	PHP 4-8V4000-M
1125,22	C-3			M	1130,30	44,50	50,80	139,70	19,84	123,83	171,45	28	164,7	PHP 4-8V4450-M
1341,12	C-3			M	1346,20	53,00	50,80	139,70	19,84	123,83	171,45	28	198,2	PHP 4-8V5300-M
8V	5	312,42	A-2	F	317,50	12,50	25,40	101,60	24,61	152,40	95,25	33	37,2	PHP 5-8V1250-F
		330,20	A-2	F	335,28	13,20	25,40	101,60	24,61	152,40	95,25	33	40,4	PHP 5-8V1320-F
		350,52	A-3	F	355,60	14,00	25,40	101,60	24,61	152,40	95,25	33	44,9	PHP 5-8V1400-F
		375,92	A-3	F	381,00	15,00	25,40	101,60	24,61	152,40	95,25	33	46,7	PHP 5-8V1500-F
		401,32	A-3	F	406,40	16,00	25,40	101,60	24,61	152,40	95,25	33	50,4	PHP 5-8V1600-F
		426,72	A-3	J	431,80	17,00	38,10	114,30	14,29	152,40	117,48	21	54,0	PHP 5-8V1700-J
		452,12	A-3	J	457,20	18,00	38,10	114,30	14,29	152,40	117,48	21	59,4	PHP 5-8V1800-J
		477,52	A-3	J	482,60	19,00	38,10	114,30	14,29	152,40	117,48	21	64,4	PHP 5-8V1900-J
		502,92	A-3	J	508,00	20,00	38,10	114,30	14,29	152,40	117,48	21	68,5	PHP 5-8V2000-J
		533,40	A-3	J	538,48	21,20	38,10	114,30	14,29	152,40	117,48	21	75,8	PHP 5-8V2120-J
		563,88	B-3	M	568,96	22,40	50,80	139,70	8,73	152,40	171,45	28	80,7	PHP 5-8V2240-M
		624,84	B-3	M	629,92	24,80	50,80	139,70	8,73	152,40	171,45	28	91,2	PHP 5-8V2480-M
		756,92	B-3	M	762,00	30,00	50,80	139,70	8,73	152,40	171,45	28	110,2	PHP 5-8V3000-M
		896,62	B-3	M	901,70	35,50	50,80	139,70	8,73	152,40	171,45	28	126,1	PHP 5-8V3550-M
		1010,92	B-3	M	1016,00	40,00	50,80	139,70	8,73	152,40	171,45	28	154,2	PHP 5-8V4000-M

* Mass does not include bushings.

Narrow wedge belt pulleys

8V QD bushed

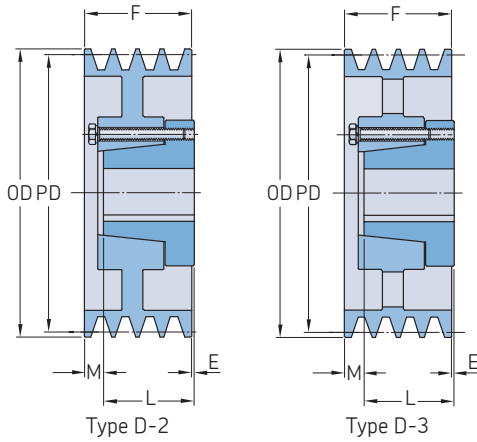

Section	Number of grooves	Pitch diameter PD	Pulley type	Bushing number	Dimensions							Mass*	Designation			
					Outer diameter OD	Bore Min.	Max.	E	F	L	M					
		mm			mm	in.							kg			
8V	5	1125,22	C-3	N	1130,30	44,50	61,91	138,11	28,58	152,40	206,38	25	189,6	PHP 5-8V4450-N		
		1341,12	C-3	N	1346,20	53,00	61,91	138,11	28,58	152,40	206,38	25	225,0	PHP 5-8V5300-N		
8V	6	312,42	A-2	F	317,50	12,50	25,40	101,60	24,61	180,98	95,25	61	40,8	PHP 6-8V1250-F		
		330,20	A-2	F	335,28	13,20	25,40	101,60	24,61	180,98	95,25	61	44,5	PHP 6-8V1320-F		
		350,52	A-3	F	355,60	14,00	25,40	101,60	24,61	180,98	95,25	61	50,8	PHP 6-8V1400-F		
		375,92	A-2	J	381,00	15,00	38,10	114,30	28,58	180,98	117,48	35	55,8	PHP 6-8V1500-J		
		401,32	A-3	J	406,40	16,00	38,10	114,30	28,58	180,98	117,48	35	58,5	PHP 6-8V1600-J		
		426,72	A-3	J	431,80	17,00	38,10	114,30	28,58	180,98	117,48	35	61,7	PHP 6-8V1700-J		
		452,12	A-3	J	457,20	18,00	38,10	114,30	28,58	180,98	117,48	35	64,9	PHP 6-8V1800-J		
		477,52	A-3	J	482,60	19,00	38,10	114,30	28,58	180,98	117,48	35	71,2	PHP 6-8V1900-J		
		502,92	B-3	M	508,00	20,00	50,80	139,70	34,13	180,98	171,45	25	81,2	PHP 6-8V2000-M		
		533,40	B-3	M	538,48	21,20	50,80	139,70	34,13	180,98	171,45	25	87,5	PHP 6-8V2120-M		
		563,88	B-3	M	568,96	22,40	50,80	139,70	34,13	180,98	171,45	25	93,0	PHP 6-8V2240-M		
		624,84	A-3	M	629,92	24,80	50,80	139,70	8,73	180,98	171,45	1	106,6	PHP 6-8V2480-M		
		756,92	A-3	M	762,00	30,00	50,80	139,70	8,73	180,98	171,45	1	129,3	PHP 6-8V3000-M		
		896,62	C-3	N	901,70	35,50	61,91	138,11	23,81	180,98	206,38	2	154,2	PHP 6-8V3550-N		
		1010,92	C-3	N	1016,00	40,00	61,91	138,11	23,81	180,98	206,38	2	178,7	PHP 6-8V4000-N		
		1125,22	C-3	N	1130,30	44,50	61,91	138,11	23,81	180,98	206,38	2	221,8	PHP 6-8V4450-N		
		1341,12	C-3	N	1346,20	53,00	61,91	138,11	23,81	180,98	206,38	2	264,9	PHP 6-8V5300-N		
		8V	8	312,42	A-1	J	317,50	12,50	38,10	114,30	53,98	238,13	117,48	67	59,4	PHP 8-8V1250-J
				330,20	A-1	J	335,28	13,20	38,10	114,30	53,98	238,13	117,48	67	72,6	PHP 8-8V1320-J
				350,52	A-2	J	355,60	14,00	38,10	114,30	53,98	238,13	117,48	67	79,4	PHP 8-8V1400-J
375,92	A-2			J	381,00	15,00	38,10	114,30	53,98	238,13	117,48	67	84,4	PHP 8-8V1500-J		
401,32	A-2			J	406,40	16,00	38,10	114,30	53,98	238,13	117,48	67	95,3	PHP 8-8V1600-J		
426,72	A-2			M	431,80	17,00	50,80	139,70	59,53	238,13	171,45	7	100,2	PHP 8-8V1700-M		
452,12	A-2			M	457,20	18,00	50,80	139,70	59,53	238,13	171,45	7	106,6	PHP 8-8V1800-M		
477,52	A-3			M	482,60	19,00	50,80	139,70	59,53	238,13	171,45	7	113,4	PHP 8-8V1900-M		
502,92	A-3			M	508,00	20,00	50,80	139,70	59,53	238,13	171,45	7	120,2	PHP 8-8V2000-M		
533,40	A-3			M	538,48	21,20	50,80	139,70	59,53	238,13	171,45	7	127,0	PHP 8-8V2120-M		
563,88	A-3			M	568,96	22,40	50,80	139,70	59,53	238,13	171,45	7	133,8	PHP 8-8V2240-M		
624,84	A-2			N	629,92	24,80	61,91	138,11	4,76	238,13	206,38	17	145,2	PHP 8-8V2480-N		
756,92	A-3			N	762,00	30,00	61,91	138,11	4,76	238,13	206,38	17	170,1	PHP 8-8V3000-N		
896,62	A-3			N	901,70	35,50	61,91	138,11	4,76	238,13	206,38	17	200,5	PHP 8-8V3550-N		
1010,92	A-3			N	1016,00	40,00	61,91	138,11	4,76	238,13	206,38	17	240,4	PHP 8-8V4000-N		
1125,22	B-3			P	1130,30	44,50	74,61	177,80	6,35	238,13	238,13	6	276,7	PHP 8-8V4450-P		
1341,12	B-3			P	1346,20	53,00	74,61	177,80	6,35	238,13	238,13	6	360,6	PHP 8-8V5300-P		
8V	10			312,42	A-1	J	317,50	12,50	38,10	114,30	53,98	295,28	117,48	131	70,3	PHP 10-8V1250-J
				330,20	A-1	J	335,28	13,20	38,10	114,30	53,98	295,28	117,48	131	86,2	PHP 10-8V1320-J
				350,52	A-1	J	355,60	14,00	38,10	114,30	53,98	295,28	117,48	131	95,3	PHP 10-8V1400-J
		375,92	A-1	M	381,00	15,00	50,80	139,70	59,53	295,28	171,45	64	120,7	PHP 10-8V1500-M		
		401,32	A-2	M	406,40	16,00	50,80	139,70	59,53	295,28	171,45	64	116,1	PHP 10-8V1600-M		
		426,72	A-1	M	431,80	17,00	50,80	139,70	59,53	295,28	171,45	64	127,5	PHP 10-8V1700-M		
		452,12	A-2	M	457,20	18,00	50,80	139,70	59,53	295,28	171,45	64	131,5	PHP 10-8V1800-M		
		477,52	A-2	M	482,60	19,00	50,80	139,70	59,53	295,28	171,45	64	136,5	PHP 10-8V1900-M		
		502,92	A-2	M	508,00	20,00	50,80	139,70	59,53	295,28	171,45	64	147,4	PHP 10-8V2000-M		
		533,40	A-2	M	538,48	21,20	50,80	139,70	59,53	295,28	171,45	64	154,2	PHP 10-8V2120-M		
		563,88	A-2	N	568,96	22,40	61,91	138,11	4,76	295,28	206,38	84	165,6	PHP 10-8V2240-N		
		624,84	A-2	N	629,92	24,80	61,91	138,11	4,76	295,28	206,38	84	176,9	PHP 10-8V2480-N		
		756,92	A-3	N	762,00	30,00	61,91	138,11	4,76	295,28	206,38	84	197,3	PHP 10-8V3000-N		
		896,62	A-2	P	901,70	35,50	74,61	177,80	6,35	295,28	238,13	51	230,0	PHP 10-8V3550-P		
		1010,92	A-3	P	1016,00	40,00	74,61	177,80	6,35	295,28	238,13	51	279,0	PHP 10-8V4000-P		
		1125,22	A-2	P	1130,30	44,50	74,61	177,80	6,35	295,28	238,13	51	322,1	PHP 10-8V4450-P		

* Mass does not include bushings.

Narrow wedge belt pulleys

8V QD bushed

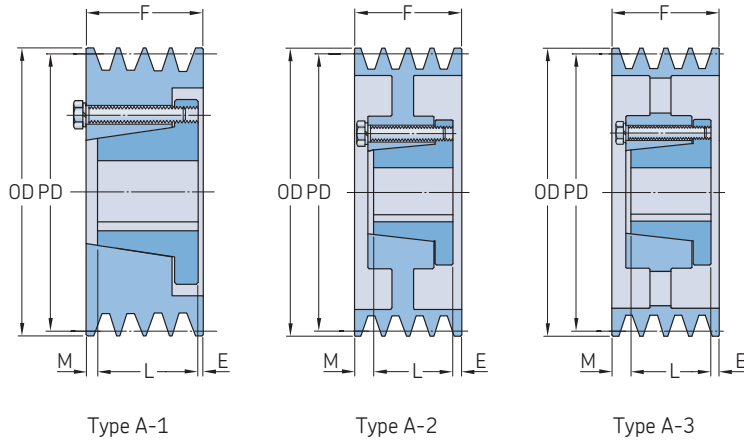

Section	Number of grooves	Pitch diameter PD	Pulley type	Bushing number	Dimensions		Bore Min.	Bore Max.	E	F	L	M	Mass*	Designation	
					Outer diameter OD	in.									
		mm			mm									kg	
8V	10	1341,12	A-3	P	1346,20	53,00	74,61	177,80	6,35	295,28	238,13	51	428,6	PHP 10-8V5300-P	
8V	12	312,42	A-1	M	317,50	12,50	50,80	139,70	59,53	339,73	171,45	121	88,5	PHP 12-8V1250-M	
		330,20	A-1	M	335,28	13,20	50,80	139,70	59,53	339,73	171,45	121	104,3	PHP 12-8V1320-M	
		350,52	A-1	M	355,60	14,00	50,80	139,70	59,53	339,73	171,45	121	113,4	PHP 12-8V1400-M	
		375,92	A-1	M	381,00	15,00	50,80	139,70	59,53	339,73	171,45	121	121,6	PHP 12-8V1500-M	
		401,32	A-1	M	406,40	16,00	50,80	139,70	59,53	339,73	171,45	121	134,3	PHP 12-8V1600-M	
			426,72	A-1	M	431,80	17,00	50,80	139,70	59,53	339,73	171,45	121	154,7	PHP 12-8V1700-M
			452,12	A-1	M	457,20	18,00	50,80	139,70	59,53	339,73	171,45	121	156,5	PHP 12-8V1800-M
			477,52	A-1	N	482,60	19,00	61,91	138,11	4,76	339,73	206,38	141	159,7	PHP 12-8V1900-N
			502,92	A-1	N	508,00	20,00	61,91	138,11	4,76	339,73	206,38	141	174,6	PHP 12-8V2000-N
			533,40	A-1	N	538,48	21,20	61,91	138,11	4,76	339,73	206,38	141	181,4	PHP 12-8V2120-N
			563,88	A-1	N	568,96	22,40	61,91	138,11	4,76	339,73	206,38	141	197,3	PHP 12-8V2240-N
			624,84	A-1	N	629,92	24,80	61,91	138,11	4,76	339,73	206,38	141	208,7	PHP 12-8V2480-N
			756,92	A-2	P	762,00	30,00	74,61	177,80	6,35	339,73	238,13	108	224,5	PHP 12-8V3000-P
			896,62	A-2	P	901,70	35,50	74,61	177,80	6,35	339,73	238,13	108	259,5	PHP 12-8V3550-P
			1010,92	A-2	P	1016,00	40,00	74,61	177,80	6,35	339,73	238,13	108	317,5	PHP 12-8V4000-P
		1125,22	A-2	P	1130,30	44,50	74,61	177,80	6,35	339,73	238,13	108	374,2	PHP 12-8V4450-P	
		1341,12	A-2	P	1346,20	53,00	74,61	177,80	6,35	339,73	238,13	108	489,9	PHP 12-8V5300-P	

* Mass does not include bushings.

HiTD pulleys

3 mm pitch pilot bore (RSB) | 5 mm pitch pilot bore (RSB)

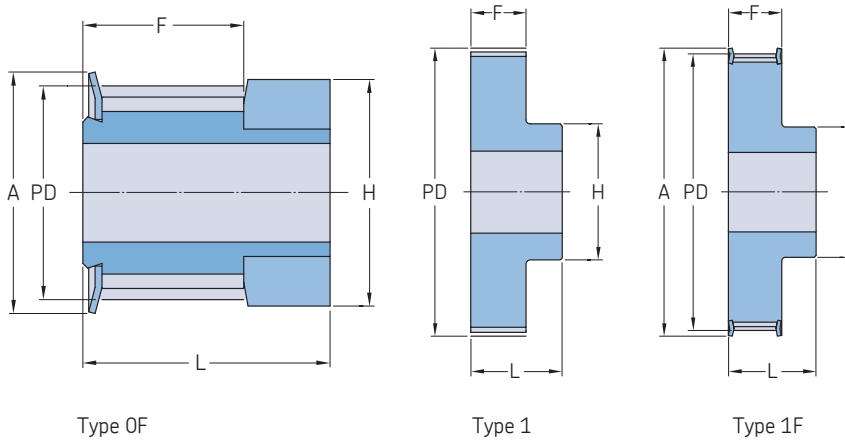

Pitch	Belt width	Pitch diameter PD	Number of teeth	Pulley type	Dimensions									Mass	Designation	
					Outer diameter OD	A	B Min.	B Max.	F	K	L	M	H			
mm					mm									kg		
3	09	9,55	10	0F	8,79	13,0	-	4,0	10,2	-	17,5	-	13,0	0,04	PHP 10-3M-09RSB	
		11,46	12	0F	10,70	15,0	-	6,0	10,2	-	17,5	-	15,0	0,06	PHP 12-3M-09RSB	
		13,37	14	0F	12,61	16,0	-	7,0	10,2	-	17,5	-	16,0	0,07	PHP 14-3M-09RSB	
		14,32	15	0F	13,56	17,5	-	8,0	10,2	-	17,5	-	17,5	0,08	PHP 15-3M-09RSB	
		15,28	16	1F	14,52	18,0	4	6,0	12,8	-	20,6	-	10,0	0,07	PHP 16-3M-09RSB	
		17,19	18	1F	16,43	19,5	6	6,5	12,8	-	20,6	-	11,0	0,08	PHP 18-3M-09RSB	
		19,10	20	1F	18,34	23,0	6	8,0	12,8	-	20,6	-	13,0	0,01	PHP 20-3M-09RSB	
		20,05	21	1F	19,29	25,0	6	8,5	12,8	-	20,6	-	14,0	0,01	PHP 21-3M-09RSB	
		21,01	22	1F	20,25	25,0	6	8,5	12,8	-	20,6	-	14,0	0,01	PHP 22-3M-09RSB	
		22,92	24	1F	22,16	25,0	6	8,5	12,8	-	20,6	-	14,0	0,02	PHP 24-3M-09RSB	
		24,83	26	1F	24,07	28,0	6	10,5	12,8	-	20,6	-	16,0	0,02	PHP 26-3M-09RSB	
		26,74	28	1F	25,98	32,0	6	11,5	12,8	-	20,6	-	18,0	0,02	PHP 28-3M-09RSB	
	28,65	30	1F	27,89	32,0	6	12,5	12,8	-	20,6	-	20,0	0,03	PHP 30-3M-09RSB		
	30,56	32	1F	29,80	36,0	6	14,0	12,8	-	20,6	-	22,0	0,03	PHP 32-3M-09RSB		
	34,38	36	1F	33,62	38,0	6	17,0	13,4	-	22,2	-	26,0	0,05	PHP 36-3M-09RSB		
	38,20	40	1F	37,44	42,0	6	19,0	13,4	-	22,2	-	28,0	0,06	PHP 40-3M-09RSB		
	42,02	44	1F	41,26	48,0	6	22,5	13,4	-	22,2	-	33,0	0,07	PHP 44-3M-09RSB		
	45,84	48	1	45,08	-	8	22,5	13,4	-	22,2	-	33,0	0,07	PHP 48-3M-09RSB		
	57,30	60	1	56,54	-	8	22,5	13,4	-	22,2	-	33,0	0,11	PHP 60-3M-09RSB		
	68,75	72	1	67,99	-	8	22,5	13,4	-	22,2	-	33,0	0,14	PHP 72-3M-09RSB		
	3	15	9,55	10	0F	8,79	13,0	-	3,0	17,0	-	26,0	-	13,0	0,04	PHP 10-3M-15RSB
			11,46	12	0F	10,70	15,0	-	5,0	17,0	-	26,0	-	15,0	0,06	PHP 12-3M-15RSB
			13,37	14	0F	12,61	16,0	-	6,0	17,0	-	26,0	-	16,0	0,07	PHP 14-3M-15RSB
			14,32	15	0F	13,56	17,5	-	6,0	17,0	-	26,0	-	17,5	0,08	PHP 15-3M-15RSB
15,28			16	1F	14,52	18,0	4	7,0	19,5	-	26,0	-	10,0	0,07	PHP 16-3M-15RSB	
17,19			18	1F	16,43	19,5	6	8,0	19,5	-	26,0	-	11,0	0,08	PHP 18-3M-15RSB	
19,10			20	1F	18,34	23,0	6	9,0	19,5	-	26,0	-	13,0	0,01	PHP 20-3M-15RSB	
20,05			21	1F	19,29	25,0	6	9,0	19,5	-	26,0	-	14,0	0,01	PHP 21-3M-15RSB	
21,01			22	1F	20,25	25,0	6	9,0	19,5	-	26,0	-	14,0	0,01	PHP 22-3M-15RSB	
22,92			24	1F	22,16	25,0	6	9,0	19,5	-	26,0	-	14,0	0,02	PHP 24-3M-15RSB	
24,83			26	1F	24,07	28,0	6	11,0	19,5	-	26,0	-	16,0	0,02	PHP 26-3M-15RSB	
26,74			28	1F	25,98	32,0	6	12,0	19,5	-	26,0	-	18,0	0,02	PHP 28-3M-15RSB	
28,65		30	1F	27,89	32,0	6	14,0	19,5	-	26,0	-	20,0	0,03	PHP 30-3M-15RSB		
30,56		32	1F	29,80	36,0	6	15,0	19,5	-	26,0	-	22,0	0,03	PHP 32-3M-15RSB		
34,38		36	1F	33,62	38,0	6	16,0	20,0	-	30,0	-	26,0	0,05	PHP 36-3M-15RSB		
38,20		40	1F	37,44	42,0	6	18,0	20,0	-	30,0	-	28,0	0,06	PHP 40-3M-15RSB		
42,02		44	1F	41,26	48,0	6	20,0	20,0	-	30,0	-	33,0	0,07	PHP 44-3M-15RSB		
45,84		48	1	45,08	-	8	20,0	20,0	-	30,0	-	33,0	0,07	PHP 48-3M-15RSB		
57,30		60	1	56,54	-	8	20,0	20,0	-	30,0	-	33,0	0,11	PHP 60-3M-15RSB		
68,75		72	1	67,99	-	8	20,0	20,0	-	30,0	-	33,0	0,14	PHP 72-3M-15RSB		
5		09	19,10	12	1F	17,96	25,0	4	8,0	14,5	-	20,0	-	13,0	0,03	PHP 12-5M-09RSB
			22,28	14	1F	21,14	25,0	6	9,0	14,5	-	20,0	-	13,0	0,03	PHP 14-5M-09RSB
			23,87	15	1F	22,73	28,0	6	11,0	14,5	-	20,0	-	16,0	0,04	PHP 15-5M-09RSB
			25,46	16	1F	24,32	28,0	6	11,0	14,5	-	20,0	-	16,0	0,05	PHP 16-5M-09RSB
	28,65		18	1F	27,51	32,0	6	13,0	14,5	-	20,0	-	19,0	0,07	PHP 18-5M-09RSB	
	31,83		20	1F	30,69	36,0	6	14,0	14,5	-	22,5	-	23,0	0,09	PHP 20-5M-09RSB	
	33,42		21	1F	32,28	38,0	6	15,0	14,5	-	22,5	-	24,0	0,11	PHP 21-5M-09RSB	
	35,01		22	1F	33,87	38,0	6	16,0	14,5	-	22,5	-	25,5	0,12	PHP 22-5M-09RSB	
	38,20		24	1F	37,06	42,0	6	18,0	14,5	-	22,5	-	27,0	0,15	PHP 24-5M-09RSB	
	41,38		26	1F	40,24	44,0	6	20,0	14,5	-	22,5	-	30,0	0,17	PHP 26-5M-09RSB	
	44,56		28	1F	43,42	48,0	6	20,0	14,5	-	22,5	-	30,5	0,20	PHP 28-5M-09RSB	
	47,75		30	1F	46,60	51,0	6	24,0	14,5	-	22,5	-	35,0	0,24	PHP 30-5M-09RSB	
	50,93	32	1F	49,79	54,0	8	26,0	14,5	-	22,5	-	38,0	0,27	PHP 32-5M-09RSB		
	57,30	36	1F	56,16	60,0	8	26,0	14,5	-	22,5	-	38,0	0,32	PHP 36-5M-09RSB		

HiTD pulleys

5 mm pitch pilot bore (RSB) | 8 mm pitch pilot bore (RSB)

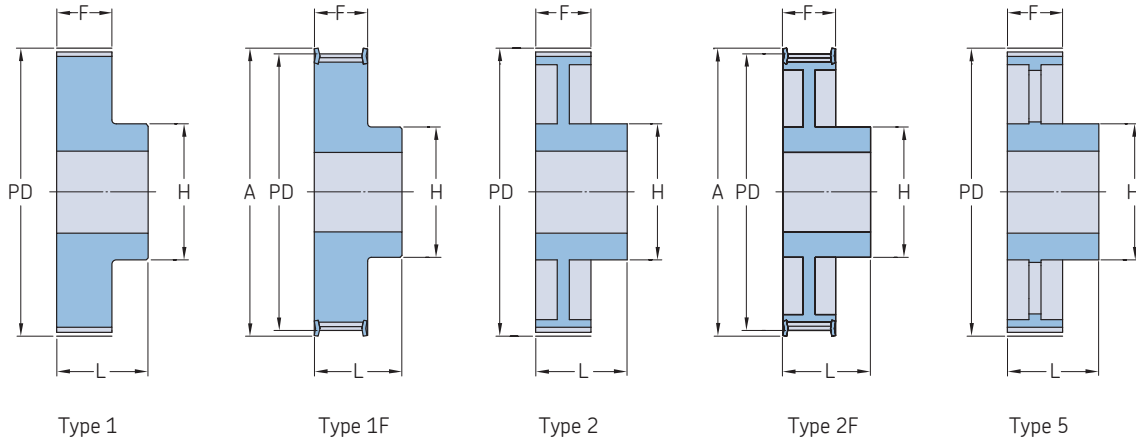

Pitch	Belt width	Pitch diameter	Number of teeth	Pulley type	Dimensions									Mass	Designation	
					Outer diameter OD	A	B Min.	Max.	F	K	L	M	H			
mm		PD	-	-	mm									kg	-	
5	09	63,66	40	1F	62,52	71,0	8	26,0	14,5	-	22,5	-	38,0	0,40	PHP 40-5M-09RSB	
		70,03	44	2	68,89	-	8	26,0	14,5	-	25,5	-	38,0	0,17	PHP 44-5M-09RSB	
		76,39	48	2	75,25	-	8	26,0	14,5	-	25,5	-	38,0	0,18	PHP 48-5M-09RSB	
		95,49	60	2	94,35	-	8	30,0	14,5	-	25,5	-	45,0	0,23	PHP 60-5M-09RSB	
	114,59	72	2	113,45	-	8	30,0	14,5	-	25,5	-	45,0	0,27	PHP 72-5M-09RSB		
	5	15	19,10	12	1F	17,96	25,0	4	8,0	20,5	-	26,0	-	13,0	0,03	PHP 12-5M-15RSB
			22,28	14	1F	21,14	25,0	6	9,0	20,5	-	26,0	-	13,0	0,05	PHP 14-5M-15RSB
			23,87	15	1F	22,73	28,0	6	11,0	20,5	-	26,0	-	16,0	0,06	PHP 15-5M-15RSB
			25,46	16	1F	24,32	28,0	6	11,0	20,5	-	26,0	-	16,0	0,06	PHP 16-5M-15RSB
			28,65	18	1F	27,51	32,0	6	13,0	20,5	-	26,0	-	19,0	0,09	PHP 18-5M-15RSB
			31,83	20	1F	30,69	36,0	6	14,0	20,5	-	26,0	-	23,0	0,11	PHP 20-5M-15RSB
		33,42	21	1F	32,28	38,0	6	15,0	20,5	-	26,0	-	24,0	0,13	PHP 21-5M-15RSB	
35,01		22	1F	33,87	38,0	6	16,0	20,5	-	26,0	-	25,5	0,14	PHP 22-5M-15RSB		
38,20		24	1F	37,06	42,0	6	18,0	20,5	-	28,0	-	27,0	0,18	PHP 24-5M-15RSB		
41,38		26	1F	40,24	44,0	6	20,0	20,5	-	28,0	-	30,0	0,22	PHP 26-5M-15RSB		
44,56		28	1F	43,42	48,0	6	20,0	20,5	-	28,0	-	30,5	0,25	PHP 28-5M-15RSB		
47,75		30	1F	46,60	51,0	6	24,0	20,5	-	28,0	-	35,0	0,30	PHP 30-5M-15RSB		
50,93		32	1F	49,79	54,0	8	26,0	20,5	-	28,0	-	38,0	0,35	PHP 32-5M-15RSB		
57,30		36	1F	56,16	60,0	8	26,0	20,5	-	28,0	-	38,0	0,52	PHP 36-5M-15RSB		
63,66		40	1F	62,52	71,0	8	26,0	20,5	-	28,0	-	38,0	0,43	PHP 40-5M-15RSB		
70,03		44	2	68,89	-	8	26,0	20,5	-	30,0	-	38,0	0,23	PHP 44-5M-15RSB		
76,39		48	2	75,25	-	8	26,0	20,5	-	30,0	-	38,0	0,19	PHP 48-5M-15RSB		
95,49		60	2	94,35	-	8	34,0	20,5	-	30,0	-	50,0	0,31	PHP 60-5M-15RSB		
114,59	72	2	113,45	-	8	34,0	20,5	-	30,0	-	50,0	0,38	PHP 72-5M-15RSB			
5	25	19,10	12	1F	17,96	25,0	4	8,0	30,5	-	36,0	5,5	13,0	0,05	PHP 12-5M-25RSB	
		22,28	14	1F	21,14	25,0	6	9,0	30,5	-	36,0	5,5	13,0	0,07	PHP 14-5M-25RSB	
		23,87	15	1F	22,73	28,0	6	11,0	30,5	-	36,0	5,5	16,0	0,08	PHP 15-5M-25RSB	
		25,46	16	1F	24,32	28,0	6	11,0	30,5	-	36,0	5,5	16,0	0,10	PHP 16-5M-25RSB	
		28,65	18	1F	27,51	32,0	6	13,0	30,5	-	36,0	5,5	19,0	0,12	PHP 18-5M-25RSB	
		31,83	20	1F	30,69	36,0	6	14,0	30,5	-	36,0	5,5	23,0	0,16	PHP 20-5M-25RSB	
	33,42	21	1F	32,28	38,0	6	15,0	30,5	-	38,0	7,5	24,0	0,19	PHP 21-5M-25RSB		
	35,01	22	1F	33,87	38,0	6	16,0	30,5	-	38,0	7,5	25,5	0,21	PHP 22-5M-25RSB		
	38,20	24	1F	37,06	42,0	6	18,0	30,5	-	38,0	7,5	27,0	0,25	PHP 24-5M-25RSB		
	41,38	26	1F	40,24	44,0	6	20,0	30,5	-	38,0	7,5	30,0	0,30	PHP 26-5M-25RSB		
	44,56	28	1F	43,42	48,0	6	20,0	30,5	-	38,0	7,5	30,5	0,35	PHP 28-5M-25RSB		
	47,75	30	1F	46,60	51,0	6	24,0	30,5	-	38,0	7,5	35,0	0,42	PHP 30-5M-25RSB		
	50,93	32	1F	49,79	54,0	8	26,0	30,5	-	38,0	7,5	38,0	0,48	PHP 32-5M-25RSB		
	57,30	36	1F	56,16	60,0	8	26,0	30,5	-	38,0	7,5	38,0	0,59	PHP 36-5M-25RSB		
	63,66	40	1F	62,52	71,0	8	26,0	30,5	-	38,0	7,5	38,0	0,74	PHP 40-5M-25RSB		
	70,03	44	2	68,89	-	8	26,0	30,5	-	40,0	9,5	38,0	0,32	PHP 44-5M-25RSB		
	76,39	48	2	72,25	-	8	26,0	30,5	-	40,0	9,5	38,0	0,28	PHP 48-5M-25RSB		
	95,49	60	2	94,35	-	8	34,0	30,5	-	40,0	9,5	50,0	0,44	PHP 60-5M-25RSB		
	114,59	72	2	113,45	-	8	34,0	30,5	-	40,0	9,5	50,0	0,53	PHP 72-5M-25RSB		
	127,32	80	1	126,18	-	8	62,0	30,5	-	40,0	-	92,0	0,60	PHP 80-5M-25RSB		
	8	20	50,93	20	1F	49,56	60,0	12	25,0	28,0	-	38,0	-	38,0	0,43	PHP 20-8M-20RSB
			53,47	21	1F	52,10	62,0	12	27,0	28,0	-	38,0	-	40,0	0,49	PHP 21-8M-20RSB
			56,02	22	1F	54,65	65,0	12	29,0	28,0	-	38,0	-	43,0	0,54	PHP 22-8M-20RSB
			58,57	23	1F	57,20	65,0	12	29,0	28,0	-	38,0	-	45,0	0,60	PHP 23-8M-20RSB
61,12			24	1F	59,75	70,0	12	30,0	28,0	-	38,0	-	45,0	0,65	PHP 24-8M-20RSB	
63,66			25	1F	62,28	71,0	12	31,0	28,0	-	38,0	-	45,0	0,73	PHP 25-8M-20RSB	
66,21		26	1F	64,84	75,0	12	32,0	28,0	-	38,0	-	50,0	0,80	PHP 26-8M-20RSB		
68,75		27	1F	67,39	75,0	12	33,0	28,0	-	38,0	-	50,0	0,84	PHP 27-8M-20RSB		
71,30		28	1F	70,08	80,0	15	34,0	28,0	-	38,0	-	50,0	0,87	PHP 28-8M-20RSB		
73,85		29	1F	72,62	85,0	15	35,0	28,0	-	38,0	-	55,0	0,95	PHP 29-8M-20RSB		

HiTD pulleys

8 mm pitch pilot bore (RSB) | 14 mm pitch pilot bore (RSB)

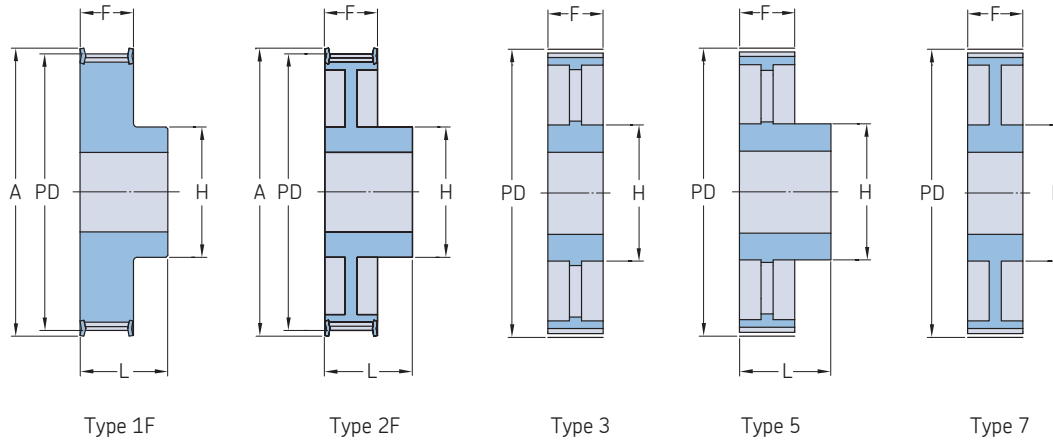

Pitch	Belt width	Pitch diameter PD	Number of teeth	Pulley type	Dimensions									Mass	Designation		
					Outer diameter OD	A	B Min.	Max.	F	K	L	M	H				
mm			-	-	mm									kg	-		
8	50	101,86	40	1F	100,49	110,0	18	50,0	60,0	-	70,0	-	75,0	3,50	PHP 40-8M-50RSB		
		104,41	42	1F	103,03	111,0	18	50,0	60,0	-	70,0	-	75,0	3,70	PHP 42-8M-50RSB		
		112,05	44	1F	110,67	121,0	18	50,0	60,0	-	70,0	-	75,0	3,90	PHP 44-8M-50RSB		
		114,59	45	1F	113,22	121,0	18	50,0	60,0	-	70,0	-	75,0	4,00	PHP 45-8M-50RSB		
		122,23	48	1F	120,86	131,0	18	54,0	60,0	-	70,0	-	80,0	4,30	PHP 48-8M-50RSB		
		124,78	50	1F	123,41	131,0	18	54,0	60,0	-	70,0	-	80,0	4,48	PHP 50-8M-50RSB		
		127,32	52	1F	125,95	140,0	18	60,0	60,0	-	70,0	-	90,0	4,65	PHP 52-8M-50RSB		
		142,60	56	7F	141,23	151,0	18	60,0	60,0	-	60,0	-	90,0	5,00	PHP 56-8M-50RSB		
		152,79	60	7F	151,42	158,0	18	60,0	60,0	-	60,0	-	90,0	5,30	PHP 60-8M-50RSB		
		162,97	64	7F	161,60	171,0	18	60,0	60,0	-	60,0	-	100,0	5,60	PHP 64-8M-50RSB		
		183,35	72	7F	181,97	192,0	18	63,0	60,0	-	60,0	-	100,0	6,80	PHP 72-8M-50RSB		
		203,72	80	7	202,35	-	18	60,0	60,0	-	60,0	-	110,0	6,90	PHP 80-8M-50RSB		
		229,18	90	7	227,81	-	18	60,0	60,0	-	60,0	-	110,0	8,60	PHP 90-8M-50RSB		
		285,21	112	3	283,83	-	20	60,0	60,0	-	60,0	-	110,0	9,60	PHP 112-8M-50RSB		
		366,69	144	3	365,32	-	20	60,0	60,0	-	60,0	-	110,0	13,80	PHP 144-8M-50RSB		
		427,81	168	3	426,44	-	20	60,0	60,0	-	60,0	-	120,0	16,00	PHP 168-8M-50RSB		
		488,92	192	3	487,55	-	20	60,0	60,0	-	60,0	-	130,0	22,40	PHP 192-8M-50RSB		
		8	85	56,02	22	1F	54,65	65,0	12	29,0	95,0	-	105,0	-	43,0	1,55	PHP 22-8M-85RSB
				58,57	23	1F	57,20	65,0	12	30,0	95,0	-	105,0	-	45,0	1,73	PHP 23-8M-85RSB
				61,12	24	1F	59,75	70,0	12	30,0	95,0	-	105,0	-	45,0	1,90	PHP 24-8M-85RSB
63,66	25			1F	62,28	70,0	12	34,0	95,0	-	105,0	-	50,0	2,08	PHP 25-8M-85RSB		
66,21	26			1F	64,84	75,0	12	34,0	95,0	-	105,0	-	50,0	2,25	PHP 26-8M-85RSB		
68,75	27			1F	67,39	75,0	12	34,0	95,0	-	105,0	-	50,0	2,40	PHP 27-8M-85RSB		
71,30	28			1F	70,08	80,0	15	34,0	95,0	-	105,0	-	50,0	2,55	PHP 28-8M-85RSB		
76,39	30			1F	75,13	85,0	15	35,0	95,0	-	105,0	-	55,0	3,00	PHP 30-8M-85RSB		
78,94	31			1F	77,65	87,0	15	38,0	95,0	-	105,0	-	55,0	3,23	PHP 31-8M-85RSB		
81,49	32			1F	80,16	90,0	15	42,0	95,0	-	105,0	-	60,0	3,57	PHP 32-8M-85RSB		
84,03	33			1F	82,68	90,0	15	44,0	95,0	-	105,0	-	60,0	3,75	PHP 33-8M-85RSB		
86,58	34			1F	85,22	95,0	15	44,0	95,0	-	105,0	-	70,0	4,00	PHP 34-8M-85RSB		
89,13	35			1F	87,76	95,0	15	44,0	95,0	-	105,0	-	70,0	4,25	PHP 35-8M-85RSB		
91,67	36			1F	90,30	100,0	15	44,0	95,0	-	105,0	-	70,0	4,50	PHP 36-8M-85RSB		
96,77	38			1F	95,39	106,0	15	50,0	95,0	-	105,0	-	75,0	4,90	PHP 38-8M-85RSB		
101,86	40			1F	100,49	110,0	18	50,0	95,0	-	105,0	-	75,0	5,20	PHP 40-8M-85RSB		
106,95	42			1F	105,58	110,0	18	50,0	95,0	-	105,0	-	75,0	6,08	PHP 42-8M-85RSB		
112,05	44			1F	110,67	121,0	18	50,0	95,0	-	105,0	-	75,0	6,60	PHP 44-8M-85RSB		
114,59	45			1F	113,22	121,0	18	50,0	95,0	-	105,0	-	75,0	6,85	PHP 45-8M-85RSB		
122,23	48			1F	120,86	131,0	18	54,0	95,0	-	105,0	-	80,0	7,60	PHP 48-8M-85RSB		
127,32	50	1F	125,95	131,0	20	54,0	95,0	-	105,0	-	80,0	8,15	PHP 50-8M-85RSB				
132,42	52	1F	131,05	140,0	20	54,0	95,0	-	105,0	-	80,0	8,70	PHP 52-8M-85RSB				
142,60	56	1F	141,23	151,0	20	54,0	95,0	-	105,0	-	80,0	9,80	PHP 56-8M-85RSB				
152,79	60	7F	151,42	158,0	20	66,0	95,0	-	95,0	-	100,0	10,10	PHP 60-8M-85RSB				
162,97	64	7F	161,60	171,0	20	66,0	95,0	-	95,0	-	100,0	10,40	PHP 64-8M-85RSB				
183,35	72	7F	181,97	192,0	20	66,0	95,0	-	95,0	-	110,0	11,40	PHP 72-8M-85RSB				
203,72	80	3	202,35	-	20	66,0	95,0	-	95,0	-	110,0	11,10	PHP 80-8M-85RSB				
229,18	90	3	227,81	-	20	66,0	95,0	-	95,0	-	110,0	13,20	PHP 90-8M-85RSB				
285,21	112	3	283,83	-	24	66,0	95,0	-	95,0	-	110,0	16,30	PHP 112-8M-85RSB				
366,69	144	3	365,32	-	24	72,0	95,0	-	95,0	-	120,0	21,50	PHP 144-8M-85RSB				
427,81	168	3	426,44	-	24	72,0	95,0	-	95,0	-	120,0	26,10	PHP 168-8M-85RSB				
488,92	192	3	487,55	-	24	78,0	95,0	-	95,0	-	130,0	30,60	PHP 192-8M-85RSB				
14	40	124,78	28	1F	122,12	127,0	24	67,0	54,0	-	69,0	-	100,0	4,73	PHP 28-14M-40RSB		
		129,23	29	1F	126,57	138,0	24	67,0	54,0	-	69,0	-	100,0	5,09	PHP 29-14M-40RSB		
		133,69	30	1F	130,99	138,0	24	67,0	54,0	-	69,0	-	100,0	5,45	PHP 30-14M-40RSB		
		142,60	32	1F	139,88	154,0	24	67,0	54,0	-	69,0	-	100,0	6,17	PHP 32-14M-40RSB		

HiTD pulleys
14 mm pitch pilot bore (RSB)

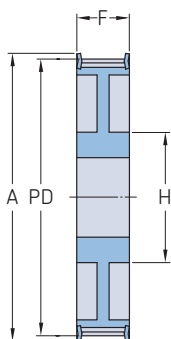

Type 7F

Pitch	Belt width	Pitch diameter PD	Number of teeth	Pulley type	Dimensions									Mass	Designation	
					Outer diameter OD	A	B Min.	Max.	F	K	L	M	H			
mm			-	-	mm									kg	-	
14	40	151,52	34	1F	148,79	160,0	24	67,0	54,0	-	69,0	-	100,0	6,88	PHP 34-14M-40RSB	
		160,43	36	1F	157,68	168,0	24	67,0	54,0	-	69,0	-	100,0	7,60	PHP 36-14M-40RSB	
		169,34	38	1F	166,60	183,0	24	80,0	54,0	-	69,0	-	120,0	8,28	PHP 38-14M-40RSB	
		178,25	40	1F	175,49	188,0	24	80,0	54,0	-	69,0	-	120,0	9,26	PHP 40-14M-40RSB	
		196,08	44	1F	193,28	211,0	24	80,0	54,0	-	69,0	-	120,0	10,32	PHP 44-14M-40RSB	
		213,90	48	2F	211,11	226,0	24	82,0	54,0	-	69,0	-	135,0	11,50	PHP 48-14M-40RSB	
		249,55	56	2F	246,76	256,0	28	82,0	54,0	-	69,0	-	135,0	13,05	PHP 56-14M-40RSB	
		285,21	64	2F	282,41	296,0	28	82,0	54,0	-	69,0	-	135,0	14,40	PHP 64-14M-40RSB	
		320,86	72	5	318,06	-	28	82,0	54,0	-	69,0	-	135,0	16,90	PHP 72-14M-40RSB	
		356,51	80	5	353,71	-	28	82,0	54,0	-	69,0	-	135,0	18,50	PHP 80-14M-40RSB	
		401,07	90	5	398,28	-	28	82,0	54,0	-	69,0	-	135,0	20,00	PHP 90-14M-40RSB	
		499,11	112	5	496,32	-	28	82,0	54,0	-	69,0	-	135,0	26,70	PHP 112-14M-40RSB	
	641,71	144	5	638,92	-	28	82,0	54,0	-	69,0	-	135,0	35,00	PHP 144-14M-40RSB		
	748,66	168	5	745,87	-	28	82,0	54,0	-	69,0	-	135,0	44,20	PHP 168-14M-40RSB		
	855,92	192	5	852,82	-	28	82,0	54,0	-	69,0	-	135,0	52,20	PHP 192-14M-40RSB		
	962,57	216	5	959,76	-	28	90,0	54,0	-	69,0	-	150,0	60,00	PHP 216-14M-40RSB		
	14	55	124,78	28	1F	122,12	127,0	24	67,0	70,0	-	85,0	-	100,0	5,60	PHP 28-14M-55RSB
			129,23	29	1F	126,57	138,0	24	67,0	70,0	-	85,0	-	100,0	6,10	PHP 29-14M-55RSB
			133,69	30	1F	130,99	138,0	24	67,0	70,0	-	85,0	-	100,0	6,60	PHP 30-14M-55RSB
			142,60	32	1F	139,88	154,0	24	67,0	70,0	-	85,0	-	100,0	7,60	PHP 32-14M-55RSB
151,52			34	1F	148,79	160,0	24	67,0	70,0	-	85,0	-	100,0	8,60	PHP 34-14M-55RSB	
160,43			36	1F	157,68	168,0	24	67,0	70,0	-	85,0	-	100,0	9,60	PHP 36-14M-55RSB	
169,34			38	1F	166,60	183,0	24	80,0	70,0	-	85,0	-	120,0	10,80	PHP 38-14M-55RSB	
178,25			40	1F	175,49	188,0	24	80,0	70,0	-	85,0	-	120,0	11,20	PHP 40-14M-55RSB	
196,08			44	1F	193,28	211,0	24	80,0	70,0	-	85,0	-	120,0	12,50	PHP 44-14M-55RSB	
213,90			48	7F	211,11	226,0	24	82,0	70,0	-	70,0	-	135,0	13,70	PHP 48-14M-55RSB	
249,55			56	7F	246,76	256,0	28	82,0	70,0	-	70,0	-	135,0	14,50	PHP 56-14M-55RSB	
285,21			64	7F	282,41	296,0	28	82,0	70,0	-	70,0	-	135,0	15,60	PHP 64-14M-55RSB	
320,86		72	3	318,06	-	28	82,0	70,0	-	70,0	-	135,0	18,50	PHP 72-14M-55RSB		
356,51		80	3	353,71	-	28	82,0	70,0	-	70,0	-	135,0	20,00	PHP 80-14M-55RSB		
401,07		90	3	398,28	-	28	82,0	70,0	-	70,0	-	135,0	22,60	PHP 90-14M-55RSB		
499,11		112	3	496,32	-	28	82,0	70,0	-	70,0	-	135,0	29,50	PHP 112-14M-55RSB		
641,71		144	3	638,92	-	28	82,0	70,0	-	70,0	-	135,0	39,00	PHP 144-14M-55RSB		
748,66		168	3	745,87	-	28	82,0	70,0	-	70,0	-	135,0	48,50	PHP 168-14M-55RSB		
855,92		192	3	852,82	-	28	82,0	70,0	-	70,0	-	135,0	57,80	PHP 192-14M-55RSB		
962,57		216	3	959,76	-	28	82,0	70,0	-	70,0	-	150,0	67,00	PHP 216-14M-55RSB		
14	85	124,78	28	1F	122,12	127,0	24	67,0	102,0	-	117,0	-	100,0	7,70	PHP 28-14M-85RSB	
		129,23	29	1F	126,57	138,0	24	67,0	102,0	-	117,0	-	100,0	8,40	PHP 29-14M-85RSB	
		133,69	30	1F	130,99	138,0	24	67,0	102,0	-	117,0	-	100,0	9,10	PHP 30-14M-85RSB	
		142,60	32	1F	139,88	154,0	24	67,0	102,0	-	117,0	-	100,0	10,50	PHP 32-14M-85RSB	
		151,52	34	1F	148,79	160,0	24	67,0	102,0	-	117,0	-	100,0	11,90	PHP 34-14M-85RSB	
		160,43	36	1F	157,68	168,0	32	67,0	102,0	-	117,0	-	100,0	13,20	PHP 36-14M-85RSB	
		169,34	38	1F	166,60	183,0	32	80,0	102,0	-	117,0	-	120,0	15,15	PHP 38-14M-85RSB	
		178,25	40	1F	175,49	188,0	32	90,0	102,0	-	117,0	-	135,0	17,10	PHP 40-14M-85RSB	
		196,08	44	1F	193,28	211,0	32	90,0	102,0	-	117,0	-	135,0	23,30	PHP 44-14M-85RSB	
		213,90	48	1F	211,11	226,0	32	100,0	102,0	-	117,0	-	150,0	25,00	PHP 48-14M-85RSB	
		249,55	56	7F	246,76	256,0	32	90,0	102,0	-	102,0	-	150,0	25,00	PHP 56-14M-85RSB	
		285,21	64	7F	282,41	296,0	32	90,0	102,0	-	102,0	-	150,0	28,20	PHP 64-14M-85RSB	
	320,86	72	3	318,06	-	32	90,0	102,0	-	102,0	-	150,0	28,80	PHP 72-14M-85RSB		
	356,51	80	3	353,71	-	32	90,0	102,0	-	102,0	-	150,0	30,10	PHP 80-14M-85RSB		
	401,07	90	3	398,28	-	32	90,0	102,0	-	102,0	-	150,0	33,00	PHP 90-14M-85RSB		
	499,11	112	3	496,32	-	32	90,0	102,0	-	102,0	-	150,0	41,80	PHP 112-14M-85RSB		
	641,71	144	3	638,92	-	32	90,0	102,0	-	102,0	-	150,0	52,40	PHP 144-14M-85RSB		

HiTD pulleys
14 mm pitch pilot bore (RSB)

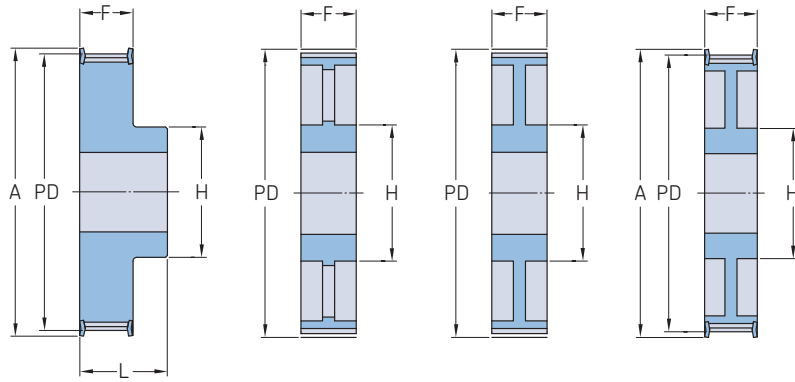

Type 1F

Type 3

Type 7

Type 7F

Pitch	Belt width	Pitch diameter PD	Number of teeth	Pulley type	Dimensions									Mass	Designation
					Outer diameter OD	A	B Min.	Max.	F	K	L	M	H		
mm			-	-	mm									kg	-
14	85	748,66	168	3	745,87	-	32	90,0	102,0	-	102,0	-	150,0	60,30	PHP 168-14M-85RSB
		855,62	192	3	852,82	-	32	100,0	102,0	-	102,0	-	165,0	70,20	PHP 192-14M-85RSB
		962,57	216	3	959,76	-	32	100,0	102,0	-	102,0	-	165,0	81,00	PHP 216-14M-85RSB
14	115	124,78	28	1F	122,12	127,0	32	67,0	133,0	-	148,0	-	100,0	9,20	PHP 28-14M-115RSB
		129,23	29	1F	126,57	138,0	32	67,0	133,0	-	148,0	-	100,0	10,20	PHP 29-14M-115RSB
		133,69	30	1F	130,99	138,0	32	67,0	133,0	-	148,0	-	100,0	11,20	PHP 30-14M-115RSB
		142,60	32	1F	139,88	154,0	32	67,0	133,0	-	148,0	-	100,0	13,20	PHP 32-14M-115RSB
		151,52	34	1F	148,79	160,0	32	67,0	133,0	-	148,0	-	100,0	14,80	PHP 34-14M-115RSB
		160,43	36	1F	157,68	168,0	32	80,0	133,0	-	148,0	-	120,0	16,60	PHP 36-14M-115RSB
		169,34	38	1F	166,60	183,0	32	80,0	133,0	-	148,0	-	120,0	19,20	PHP 38-14M-115RSB
		178,25	40	1F	175,49	188,0	32	90,0	133,0	-	148,0	-	135,0	20,56	PHP 40-14M-115RSB
		196,08	44	1F	193,28	211,0	32	94,0	133,0	-	148,0	-	140,0	26,00	PHP 44-14M-115RSB
		213,90	48	1F	211,11	226,0	32	100,0	133,0	-	148,0	-	150,0	30,00	PHP 48-14M-115RSB
		249,55	56	1F	246,76	256,0	32	100,0	133,0	-	148,0	-	150,0	36,00	PHP 56-14M-115RSB
		285,21	64	7F	282,41	296,0	32	90,0	133,0	-	133,0	-	150,0	39,00	PHP 64-14M-115RSB
		320,86	72	3	318,06	-	32	90,0	133,0	-	133,0	-	150,0	32,83	PHP 72-14M-115RSB
		356,51	80	3	353,71	-	32	90,0	133,0	-	133,0	-	150,0	35,55	PHP 80-14M-115RSB
		401,07	90	3	398,28	-	32	90,0	133,0	-	133,0	-	150,0	41,00	PHP 90-14M-115RSB
		499,11	112	3	496,32	-	32	90,0	133,0	-	133,0	-	150,0	54,40	PHP 112-14M-115RSB
		641,71	144	3	638,92	-	32	100,0	133,0	-	133,0	-	165,0	67,80	PHP 144-14M-115RSB
		748,66	168	3	745,87	-	32	100,0	133,0	-	133,0	-	165,0	75,80	PHP 168-14M-115RSB
		855,62	192	3	852,82	-	32	100,0	133,0	-	133,0	-	165,0	90,30	PHP 192-14M-115RSB
		962,57	216	3	959,76	-	32	100,0	133,0	-	133,0	-	165,0	105,00	PHP 216-14M-115RSB
14	170	124,78	28	1F	122,12	127,0	32	67,0	187,0	-	202,0	-	100,0	13,80	PHP 28-14M-170RSB
		129,23	29	1F	126,57	138,0	32	67,0	187,0	-	202,0	-	100,0	14,20	PHP 29-14M-170RSB
		133,69	30	1F	130,99	138,0	32	67,0	187,0	-	202,0	-	100,0	15,60	PHP 30-14M-170RSB
		142,60	32	1F	139,88	154,0	32	67,0	187,0	-	202,0	-	100,0	18,10	PHP 32-14M-170RSB
		151,52	34	1F	148,79	160,0	32	67,0	187,0	-	202,0	-	100,0	20,40	PHP 34-14M-170RSB
		160,43	36	1F	157,68	168,0	32	80,0	187,0	-	202,0	-	120,0	23,50	PHP 36-14M-170RSB
		169,34	38	1F	166,60	183,0	32	90,0	187,0	-	202,0	-	135,0	26,50	PHP 38-14M-170RSB
		178,25	40	1F	175,49	188,0	32	94,0	187,0	-	202,0	-	140,0	30,10	PHP 40-14M-170RSB
		196,08	44	1F	193,28	211,0	32	100,0	187,0	-	202,0	-	160,0	37,80	PHP 44-14M-170RSB
		213,90	48	1F	211,11	226,0	32	107,0	187,0	-	202,0	-	160,0	44,50	PHP 48-14M-170RSB
		249,55	56	1F	246,76	256,0	32	110,0	187,0	-	202,0	-	160,0	61,00	PHP 56-14M-170RSB
		285,21	64	1F	282,41	296,0	32	120,0	187,0	-	202,0	-	180,0	81,00	PHP 64-14M-170RSB
		320,86	72	7	318,06	-	32	120,0	187,0	-	187,0	-	180,0	61,40	PHP 72-14M-170RSB
		356,51	80	7	353,71	-	32	108,0	187,0	-	187,0	-	180,0	65,00	PHP 80-14M-170RSB
		401,07	90	3	398,28	-	38	108,0	187,0	-	187,0	-	180,0	68,00	PHP 90-14M-170RSB
		499,11	112	3	496,32	-	38	108,0	187,0	-	187,0	-	200,0	87,50	PHP 112-14M-170RSB
		641,71	144	3	638,92	-	38	108,0	187,0	-	187,0	-	220,0	114,80	PHP 144-14M-170RSB
		748,66	168	3	745,87	-	38	108,0	187,0	-	187,0	-	220,0	125,00	PHP 168-14M-170RSB
		855,62	192	3	852,82	-	38	108,0	187,0	-	187,0	-	220,0	136,40	PHP 192-14M-170RSB
		962,57	216	3	959,76	-	38	108,0	187,0	-	187,0	-	220,0	147,00	PHP 216-14M-170RSB

HiTD pulleys

5 mm pitch taper bushed | 8 mm pitch taper bushed

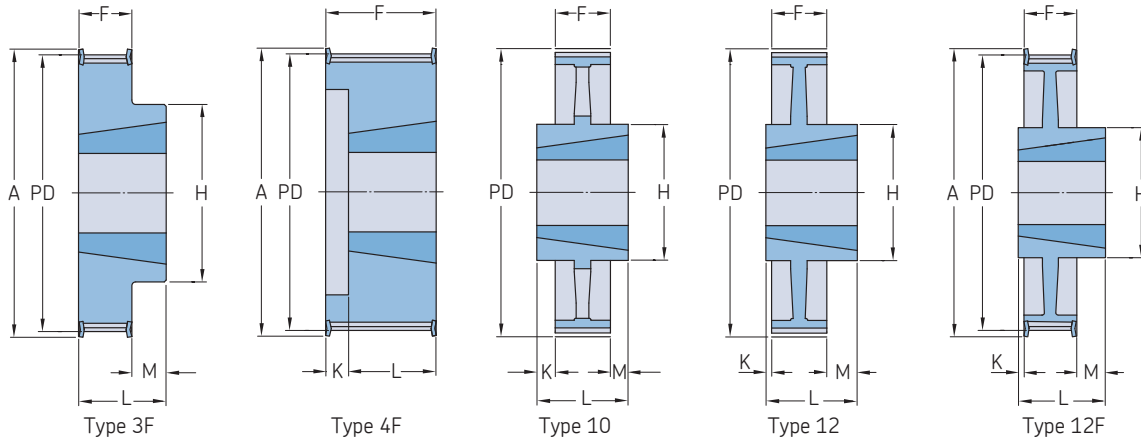

Pitch	Belt width	Pitch diameter PD	Number of teeth	Pulley type	Bushing number	Dimensions		B	Max.	F	K	L	M	H	Mass*	Designation		
						Outer diameter OD	A											
mm						mm		Min.							kg			
5	15	54,11	34	3F	1008	52,97	58	9	25,0	20,5	-	22,0	1,5	43	0,19	PHP 34-5M-15TB		
		57,30	36	3F	1108	56,16	61	9	28,0	20,5	-	22,0	1,5	45	0,20	PHP 36-5M-15TB		
		60,48	38	3F	1108	59,34	65	9	28,0	20,5	-	22,0	1,5	48	0,25	PHP 38-5M-15TB		
		63,66	40	3F	1108	62,52	68	9	28,0	20,5	-	22,0	1,5	52	0,31	PHP 40-5M-15TB		
		70,03	44	3F	1108	68,89	74	9	28,0	20,5	-	22,0	1,5	54	0,40	PHP 44-5M-15TB		
		76,39	48	3F	1210	75,25	80	11	32,0	20,5	-	25,0	4,5	64	0,45	PHP 48-5M-15TB		
		89,13	56	3F	1210	87,99	93	11	32,0	20,5	-	25,0	4,5	70	0,67	PHP 56-5M-15TB		
		101,86	64	3F	1210	100,72	106	11	32,0	20,5	-	25,0	4,5	78	0,96	PHP 64-5M-15TB		
		114,59	72	3F	1610	113,45	118	14	42,0	20,5	-	25,0	4,5	90	1,19	PHP 72-5M-15TB		
		127,32	80	3F	1610	126,18	135	14	42,0	20,5	-	25,0	4,5	92	1,57	PHP 80-5M-15TB		
		143,24	90	10	1610	142,10	-	14	42,0	20,5	2,3	25,0	2,3	92	1,47	PHP 90-5M-15TB		
		178,25	112	10	1610	177,11	-	14	42,0	20,5	2,3	25,0	2,3	92	1,94	PHP 112-5M-15TB		
		216,45	136	10	2012	215,31	-	14	50,0	20,5	5,8	32,0	5,8	106	3,06	PHP 136-5M-15TB		
		238,73	150	10	2012	237,51	-	14	50,0	20,5	5,8	32,0	5,8	106	4,50	PHP 150-5M-15TB		
		8	20	56,02	22	4F	1008	54,65	65	9	25,0	28,0	6,0	22,0	-	-	0,24	PHP 22-8M-20TB
				61,12	24	4F	1108	59,75	70	9	28,0	28,0	6,0	22,0	-	-	0,30	PHP 24-8M-20TB
				66,21	26	4F	1108	64,84	75	9	28,0	28,0	6,0	22,0	-	-	0,36	PHP 26-8M-20TB
				71,30	28	4F	1108	70,08	80	9	28,0	28,0	6,0	22,0	-	-	0,44	PHP 28-8M-20TB
76,39	30			4F	1108	75,13	85	11	28,0	28,0	6,0	22,0	-	-	0,45	PHP 30-8M-20TB		
81,49	32			4F	1610	80,16	90	11	42,0	28,0	3,0	25,0	-	-	0,50	PHP 32-8M-20TB		
86,58	34			4F	1610	85,22	95	14	42,0	28,0	3,0	25,0	-	-	0,55	PHP 34-8M-20TB		
91,67	36			4F	1610	90,30	100	14	42,0	28,0	3,0	25,0	-	-	0,68	PHP 36-8M-20TB		
96,77	38			4F	1610	95,39	106	14	42,0	28,0	3,0	25,0	-	-	0,80	PHP 38-8M-20TB		
101,86	40			4F	1610	100,49	110	14	42,0	28,0	3,0	25,0	-	-	1,00	PHP 40-8M-20TB		
106,95	42			4F	1610	105,58	110	14	42,0	28,0	3,0	25,0	-	-	1,11	PHP 42-8M-20TB		
112,05	44			3F	2012	110,67	121	14	50,0	28,0	-	32,0	4,0	92	1,20	PHP 44-8M-20TB		
122,23	48			3F	2012	120,86	131	14	50,0	28,0	-	32,0	4,0	96	1,60	PHP 48-8M-20TB		
142,60	56			3F	2012	141,23	151	14	50,0	28,0	-	32,0	4,0	110	2,40	PHP 56-8M-20TB		
152,79	60			3F	2012	151,42	162	14	50,0	28,0	-	32,0	4,0	110	2,55	PHP 60-8M-20TB		
162,97	64			12F	2012	161,60	171	14	50,0	28,0	-	32,0	4,0	110	2,70	PHP 64-8M-20TB		
183,35	72			12F	2012	181,97	192	14	50,0	28,0	-	32,0	4,0	110	3,30	PHP 72-8M-20TB		
203,72	80			12	2012	202,35	-	16	50,0	28,0	-	32,0	4,0	110	3,50	PHP 80-8M-20TB		
229,18	90	12	2012	227,81	-	16	50,0	28,0	-	32,0	4,0	110	3,65	PHP 90-8M-20TB				
8	30	50,93	20	4F	1008	49,56	60	9	25,0	38,0	16,0	22,0	-	-	0,23	PHP 20-8M-30TB		
		53,47	21	4F	1008	52,10	65	9	25,0	38,0	16,0	22,0	-	-	0,26	PHP 21-8M-30TB		
		56,02	22	4F	1008	54,65	65	9	25,0	38,0	16,0	22,0	-	-	0,29	PHP 22-8M-30TB		
		58,57	23	4F	1108	57,20	70	9	28,0	38,0	16,0	22,0	-	-	0,32	PHP 23-8M-30TB		
		61,12	24	4F	1108	59,75	70	9	28,0	38,0	16,0	22,0	-	-	0,38	PHP 24-8M-30TB		
		63,66	25	4F	1108	62,29	75	9	28,0	38,0	16,0	22,0	-	-	0,41	PHP 25-8M-30TB		
		66,21	26	4F	1108	64,84	75	9	28,0	38,0	16,0	22,0	-	-	0,45	PHP 26-8M-30TB		
		68,75	27	4F	1108	67,38	80	9	28,0	38,0	16,0	22,0	-	-	0,49	PHP 27-8M-30TB		
		71,30	28	4F	1210	70,08	80	11	32,0	38,0	16,0	25,0	-	-	0,50	PHP 28-8M-30TB		

* Mass does not include bushings.

HiTD pulleys

8 mm pitch taper bushed

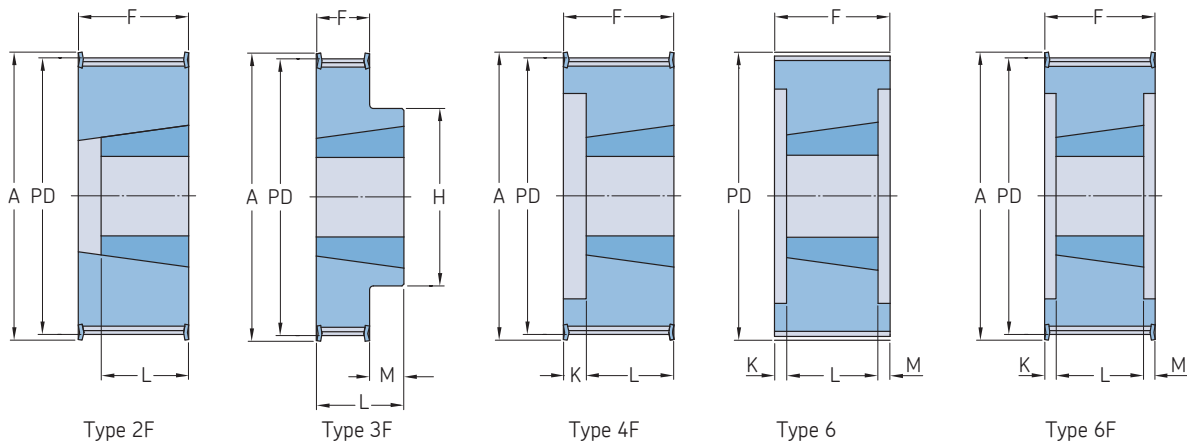

Pitch	Belt width	Pitch diameter	Number of teeth	Pulley type	Bushing number	Dimensions								Mass*	Designation	
						Outer diameter OD	A	B Min.	Max.	F	K	L	M			H
mm		PD	-	-	-	mm									kg	-
8	30	76,39	30	2F	1615	75,13	85	11	42,0	38,0	-	38,0	-	-	0,55	PHP 30-8M-30TB
		78,94	31	2F	1615	77,57	90	14	42,0	38,0	-	38,0	-	-	0,57	PHP 31-8M-30TB
		81,49	32	2F	1615	80,16	90	14	42,0	38,0	-	38,0	-	-	0,59	PHP 32-8M-30TB
		84,03	33	2F	1615	82,66	95	14	42,0	38,0	-	38,0	-	-	0,73	PHP 33-8M-30TB
		86,58	34	2F	1615	85,22	95	14	42,0	38,0	-	38,0	-	-	0,77	PHP 34-8M-30TB
		89,13	35	2F	1615	87,75	100	14	42,0	38,0	-	38,0	-	-	0,82	PHP 35-8M-30TB
		91,67	36	2F	1615	90,30	100	14	42,0	38,0	-	38,0	-	-	0,96	PHP 36-8M-30TB
		96,77	38	2F	1615	95,39	106	14	42,0	38,0	-	38,0	-	-	1,15	PHP 38-8M-30TB
		101,86	40	2F	1615	100,49	110	14	42,0	38,0	-	38,0	-	-	1,34	PHP 40-8M-30TB
		106,95	42	2F	1615	105,58	110	14	42,0	38,0	-	38,0	-	-	1,36	PHP 42-8M-30TB
		112,05	44	6F	2012	110,67	121	14	50,0	38,0	6,0	32,0	-	-	1,33	PHP 44-8M-30TB
		114,59	45	6F	2012	113,22	121	14	50,0	38,0	6,0	32,0	-	-	1,62	PHP 45-8M-30TB
		122,23	48	6F	2012	120,86	131	14	50,0	38,0	6,0	32,0	-	-	1,78	PHP 48-8M-30TB
		127,32	50	6F	2012	125,95	136	14	50,0	38,0	3,0	32,0	3,0	-	2,08	PHP 50-8M-30TB
		132,42	52	6F	2012	131,04	141	14	50,0	38,0	3,0	32,0	3,0	-	2,39	PHP 52-8M-30TB
		142,60	56	6F	2012	141,23	151	14	50,0	38,0	6,0	32,0	-	-	3,76	PHP 56-8M-30TB
		147,70	58	6F	2012	146,32	156	14	50,0	38,0	3,0	32,0	3,0	-	3,87	PHP 58-8M-30TB
		152,79	60	6F	2517	151,42	162	16	60,0	38,0	3,0	45,0	3,0	-	3,98	PHP 60-8M-30TB
		162,97	64	3F	2517	161,60	171	16	60,0	38,0	-	45,0	7,0	125	4,20	PHP 64-8M-30TB
		183,35	72	12F	2517	181,97	192	16	60,0	38,0	-	45,0	7,0	125	4,30	PHP 72-8M-30TB
203,72	80	12	2517	202,35	-	16	60,0	38,0	-	45,0	7,0	125	4,60	PHP 80-8M-30TB		
229,18	90	12	2517	227,81	-	16	60,0	38,0	-	45,0	7,0	125	5,00	PHP 90-8M-30TB		
285,21	112	12	2517	283,83	-	16	60,0	38,0	-	45,0	7,0	125	6,20	PHP 112-8M-30TB		
366,69	144	12	2517	365,32	-	16	60,0	38,0	-	45,0	7,0	125	9,00	PHP 144-8M-30TB		
427,81	168	10	3020	426,44	-	25	75,0	38,0	7,0	51,0	7,0	170	15,00	PHP 168-8M-30TB		
488,92	192	10	3525	487,55	-	35	100,0	38,0	14,0	65,0	7,0	198	18,50	PHP 192-8M-30TB		

* Mass does not include bushings.

HiTD pulleys

8 mm pitch taper bushed

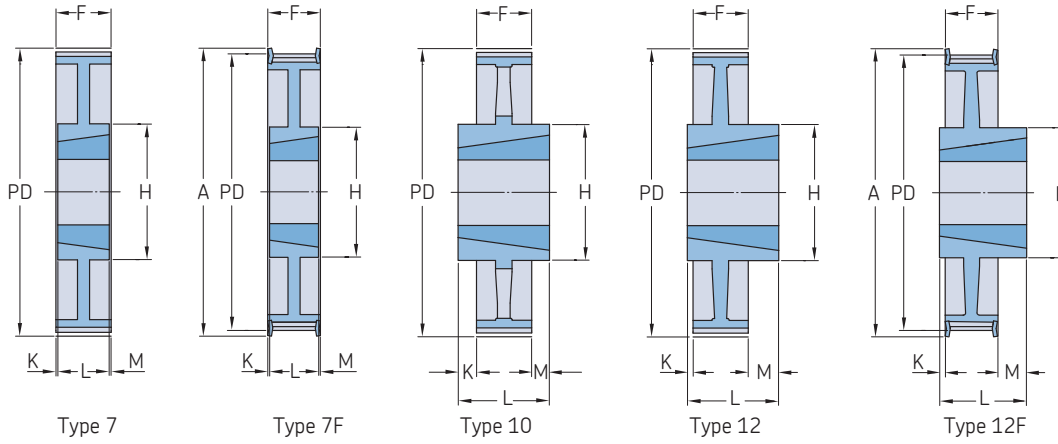

Pitch	Belt width	Pitch diameter PD	Number of teeth	Pulley type	Bushing number	Dimensions		A	B Min.	Max.	F	K	L	M	H	Mass*	Designation
						Outer diameter OD											
mm			-	-	-	mm										kg	-
8	50	61,12	24	6F	1108	59,75	70	9	32,0	60,0	19,0	22,0	19,0	-	0,35	PHP 24-8M-50TB	
		66,21	26	6F	1108	64,84	75	9	32,0	60,0	19,0	22,0	19,0	-	0,48	PHP 26-8M-50TB	
		68,75	27	6F	1108	67,38	75	9	32,0	60,0	19,0	22,0	19,0	-	0,55	PHP 27-8M-50TB	
		71,30	28	4F	1210	70,08	80	11	32,0	60,0	35,0	22,0	35,0	-	0,60	PHP 28-8M-50TB	
		76,39	30	4F	1615	75,13	85	14	42,0	60,0	23,0	25,0	-	-	0,65	PHP 30-8M-50TB	
		78,94	31	4F	1615	77,57	87	14	42,0	60,0	23,0	25,0	-	-	0,77	PHP 31-8M-50TB	
		81,49	32	4F	1615	80,16	90	14	42,0	60,0	23,0	25,0	-	-	0,82	PHP 32-8M-50TB	
		84,03	33	4F	1615	82,66	90	14	42,0	60,0	23,0	25,0	-	-	0,98	PHP 33-8M-50TB	
		86,58	34	4F	1615	85,22	95	14	42,0	60,0	23,0	25,0	-	-	1,06	PHP 34-8M-50TB	
		89,13	35	4F	1615	87,75	95	14	42,0	60,0	23,0	25,0	-	-	1,18	PHP 35-8M-50TB	
		91,67	36	4F	1615	90,30	100	14	42,0	60,0	23,0	25,0	-	-	1,30	PHP 36-8M-50TB	
		96,77	38	4F	1615	95,39	105	14	42,0	60,0	23,0	25,0	-	-	1,60	PHP 38-8M-50TB	
		101,86	40	4F	2012	100,49	110	14	50,0	60,0	29,0	32,0	-	-	1,71	PHP 40-8M-50TB	
		106,95	42	4F	2012	105,58	111	14	50,0	60,0	29,0	32,0	28,0	-	1,75	PHP 42-8M-50TB	
		112,05	44	6F	2012	110,67	121	14	50,0	60,0	-	32,0	28,0	-	1,78	PHP 44-8M-50TB	
		114,59	45	6F	2012	113,22	121	14	50,0	60,0	-	32,0	28,0	-	1,91	PHP 45-8M-50TB	
		122,23	48	6F	2012	120,86	131	14	50,0	60,0	-	32,0	28,0	-	2,30	PHP 48-8M-50TB	
		127,32	50	6F	2012	125,95	131	14	50,0	60,0	-	32,0	28,0	-	2,58	PHP 50-8M-50TB	
		132,42	52	6F	2012	131,04	140	14	50,0	60,0	-	32,0	28,0	-	2,85	PHP 52-8M-50TB	
		142,60	56	6F	2517	141,23	151	16	60,0	60,0	-	45,0	15,0	-	3,40	PHP 56-8M-50TB	
		147,70	58	6F	2517	146,32	156	16	60,0	60,0	-	45,0	15,0	-	3,80	PHP 58-8M-50TB	
		152,79	60	6F	2517	151,42	158	16	60,0	60,0	-	45,0	15,0	-	4,20	PHP 60-8M-50TB	
		162,97	64	6F	2517	161,60	171	16	60,0	60,0	-	45,0	15,0	-	5,00	PHP 64-8M-50TB	
		183,35	72	7F	2517	181,97	192	16	60,0	60,0	7,5	45,0	7,5	125	6,70	PHP 72-8M-50TB	
		203,72	80	6	3020	202,35	-	25	75,0	60,0	4,5	45,0	4,5	-	8,80	PHP 80-8M-50TB	
		229,18	90	7	3020	227,81	-	25	75,0	60,0	4,5	51,0	4,5	160	10,00	PHP 90-8M-50TB	
		285,21	112	7	3020	283,83	-	25	75,0	60,0	4,5	51,0	4,5	170	12,00	PHP 112-8M-50TB	

* Mass does not include bushings.

HiTD pulleys

8 mm pitch tapered bushed | 14 mm pitch tapered bushed

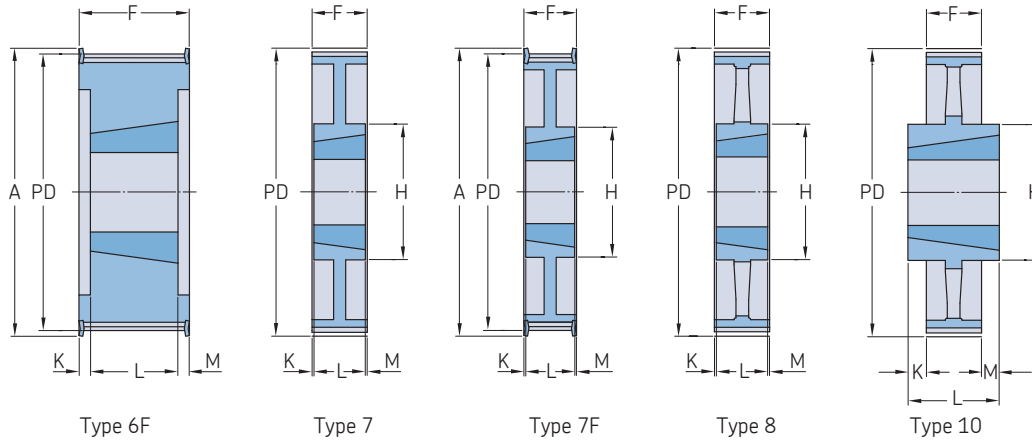

Pitch	Belt width	Pitch diameter	Number of teeth	Pulley type	Bushing number	Dimensions											Mass*	Designation
						Outer diameter OD	A	B Min.	Max.	F	K	L	M	H				
mm	mm	mm				mm									kg			
8	50	366,69	144	8	3020	365,32	-	25	75,0	60,0	4,5	51,0	4,5	170	15,20	PHP 144-8M-50TB		
		427,81	168	10	3525	426,44	-	25	100,0	60,0	4,5	51,0	4,5	170	16,40	PHP 168-8M-50TB		
		488,92	192	10	3525	487,55	-	25	100,0	60,0	4,5	51,0	4,5	170	21,80	PHP 192-8M-50TB		
		61,12	24	6F	1108	59,75	70	9	28,0	95,0	36,5	22,0	36,5	-	0,46	PHP 24-8M-85TB		
		66,21	26	6F	1108	64,84	75	9	28,0	95,0	36,5	22,0	36,5	-	0,64	PHP 26-8M-85TB		
		71,30	28	6F	1108	70,08	80	9	28,0	95,0	36,5	22,0	36,5	-	0,82	PHP 28-8M-85TB		
	8	85	76,39	30	6F	1615	75,13	85	14	42,0	95,0	36,5	22,0	36,5	-	1,17	PHP 30-8M-85TB	
			84,03	33	6F	1615	82,66	90	14	42,0	95,0	36,5	22,0	36,5	-	1,34	PHP 33-8M-85TB	
			86,58	34	6F	1615	85,22	95	14	42,0	95,0	28,5	38,0	28,5	-	1,43	PHP 34-8M-85TB	
			89,13	35	6F	1615	87,75	95	14	42,0	95,0	28,5	38,0	28,5	-	1,54	PHP 35-8M-85TB	
			91,67	36	6F	1615	90,30	100	14	42,0	95,0	28,5	38,0	28,5	-	1,87	PHP 36-8M-85TB	
			96,77	38	6F	1615	95,39	106	14	42,0	95,0	28,5	38,0	28,5	-	2,20	PHP 38-8M-85TB	
101,86			40	6F	2012	100,49	110	14	50,0	95,0	31,5	32,0	31,5	-	1,80	PHP 40-8M-85TB		
106,95			42	6F	2012	105,58	110	14	50,0	95,0	31,5	32,0	31,5	-	2,16	PHP 42-8M-85TB		
112,05			44	6F	2012	110,67	121	14	50,0	95,0	31,5	32,0	31,5	-	2,30	PHP 44-8M-85TB		
114,59			45	6F	2012	113,22	121	14	50,0	95,0	31,5	32,0	31,5	-	2,39	PHP 45-8M-85TB		
122,23			48	6F	2517	120,86	131	16	60,0	95,0	25,0	45,0	25,0	-	2,66	PHP 48-8M-85TB		
127,32			50	6F	2517	125,95	131	16	60,0	95,0	25,0	45,0	25,0	-	3,11	PHP 50-8M-85TB		
132,42			52	6F	2517	131,04	140	16	60,0	95,0	25,0	45,0	25,0	-	3,56	PHP 52-8M-85TB		
142,60			56	6F	2517	141,23	151	16	60,0	95,0	25,0	45,0	25,0	-	4,45	PHP 56-8M-85TB		
147,70			58	6F	2517	146,32	158	16	60,0	95,0	25,0	45,0	25,0	-	4,89	PHP 58-8M-85TB		
152,79			60	6F	2517	151,42	158	16	60,0	95,0	25,0	45,0	25,0	-	5,33	PHP 60-8M-85TB		
162,97			64	7F	2517	161,60	171	16	60,0	95,0	25,0	45,0	25,0	-	6,20	PHP 64-8M-85TB		
14			40	183,35	72	7	3020	181,97	192	25	75,0	95,0	22,0	51,0	22,0	-	8,00	PHP 72-8M-85TB
		203,72		80	8	3020	202,35	-	25	75,0	95,0	22,0	51,0	22,0	-	10,00	PHP 80-8M-85TB	
		229,18		90	8	3020	227,81	-	25	75,0	95,0	22,0	51,0	22,0	-	10,80	PHP 90-8M-85TB	
		285,21		112	8	3020	283,83	-	25	75,0	95,0	22,0	51,0	22,0	170	15,00	PHP 112-8M-85TB	
		366,69		144	8	3535	365,32	-	35	90,0	95,0	3,0	89,0	3,0	190	20,00	PHP 144-8M-85TB	
		427,81		168	8	3535	426,44	-	35	90,0	95,0	3,0	89,0	3,0	190	23,00	PHP 168-8M-85TB	
		488,92		192	8	3535	487,55	-	35	90,0	95,0	3,0	89,0	3,0	190	28,50	PHP 192-8M-85TB	
		124,78		28	6F	2012	122,12	141	14	50,0	54,0	11,0	32,0	11,0	-	2,66	PHP 28-14M-40TB	
		129,23		29	6F	2012	126,57	141	14	50,0	54,0	11,0	32,0	11,0	-	2,66	PHP 29-14M-40TB	
		133,69		30	6F	2012	130,99	156	14	50,0	54,0	11,0	32,0	11,0	-	2,89	PHP 30-14M-40TB	
		142,60		32	6F	2012	139,88	156	14	50,0	54,0	11,0	32,0	11,0	-	3,51	PHP 32-14M-40TB	
		151,52		34	6F	2517	148,79	165	16	60,0	54,0	4,5	45,0	4,5	-	3,87	PHP 34-14M-40TB	
		155,97		35	6F	2517	153,18	173	16	60,0	54,0	4,5	45,0	4,5	-	4,34	PHP 35-14M-40TB	
		160,43		36	6F	2517	157,68	173	16	60,0	54,0	4,5	45,0	4,5	-	4,62	PHP 36-14M-40TB	
		169,34		38	6F	2517	166,60	182	16	60,0	54,0	4,5	45,0	4,5	-	5,40	PHP 38-14M-40TB	
		178,25		40	6F	2517	175,49	191	16	60,0	54,0	4,5	45,0	4,5	-	6,23	PHP 40-14M-40TB	
		187,17		42	6F	2517	184,37	209	16	60,0	54,0	4,5	45,0	4,5	-	6,75	PHP 42-14M-40TB	
		196,08		44	6F	3020	193,28	209	25	75,0	54,0	1,5	51,0	1,5	-	7,26	PHP 44-14M-40TB	
		200,54	45	6F	3020	197,74	227	25	75,0	54,0	1,5	51,0	1,5	-	8,20	PHP 45-14M-40TB		
	213,90	48	6F	3020	211,11	227	25	75,0	54,0	1,5	51,0	1,5	-	9,33	PHP 48-14M-40TB			
	222,82	50	6F	3020	220,02	246	25	75,0	54,0	1,5	51,0	1,5	-	10,10	PHP 50-14M-40TB			
	249,55	56	6F	3020	246,76	264	25	75,0	54,0	1,5	51,0	1,5	-	10,80	PHP 56-14M-40TB			
	267,38	60	7F	3020	264,59	281	25	75,0	54,0	1,5	51,0	1,5	170	13,10	PHP 60-14M-40TB			
	285,21	64	7F	3020	282,41	296	25	75,0	54,0	1,5	51,0	1,5	170	15,40	PHP 64-14M-40TB			
	320,86	72	7	3020	318,06	-	25	75,0	54,0	1,5	51,0	1,5	170	19,75	PHP 72-14M-40TB			
	356,51	80	8	3020	353,71	-	25	75,0	54,0	1,5	51,0	1,5	170	20,00	PHP 80-14M-40TB			
	401,07	90	8	3020	398,28	-	25	75,0	54,0	1,5	51,0	1,5	170	21,80	PHP 90-14M-40TB			
	499,11	112	8	3020	496,32	-	25	75,0	54,0	1,5	51,0	1,5	170	29,60	PHP 112-14M-40TB			
	641,71	144	8	3020	638,92	-	25	75,0	54,0	1,5	51,0	1,5	170	36,00	PHP 144-14M-40TB			
	748,66	168	8	3020	745,87	-	25	75,0	54,0	1,5	51,0	1,5	170	48,00	PHP 168-14M-40TB			

* Mass does not include bushings.

HiTD pulleys
14 mm pitch taper bushed

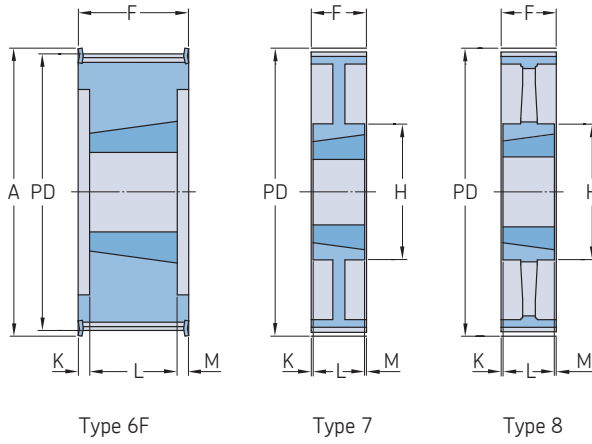

Pitch	Belt width	Pitch diameter PD	Number of teeth	Pulley type	Bushing number	Dimensions		F	K	L	M	H	Mass*	Designation		
						Outer diameter OD	A									
mm			-	-	-	mm							kg	-		
14	115	641,71	144	8	4040	638,92	-	40	100,0	133,0	15,5	102,0	15,5	230	75,00	PHP 144-14M-115TB
		748,66	168	8	4040	745,87	-	40	100,0	133,0	15,5	102,0	15,5	230	92,60	PHP 168-14M-115TB
		855,62	192	8	4040	852,92	-	40	100,0	133,0	15,5	102,0	15,5	230	230,00	PHP 192-14M-115TB
		962,57	216	8	4040	959,76	-	40	100,0	133,0	15,5	102,0	15,5	230	127,00	PHP 216-14M-115TB
14	170	155,97	35	6F	3030	153,18	173	35	75,0	187,0	55,5	76,0	55,5	-	10,60	PHP 35-14M-170TB
		160,43	36	6F	3030	157,68	173	35	75,0	187,0	55,5	76,0	55,5	-	11,20	PHP 36-14M-170TB
		169,34	38	6F	3030	167,00	182	35	75,0	187,0	55,5	76,0	55,5	-	11,70	PHP 38-14M-170TB
		178,25	40	6F	3030	175,00	191	35	75,0	187,0	55,5	76,0	55,5	-	13,00	PHP 40-14M-170TB
		187,17	42	6F	3535	184,37	202	35	90,0	187,0	49,0	89,0	49,0	-	14,00	PHP 42-14M-170TB
		196,08	44	6F	3535	193,00	209	35	90,0	187,0	49,0	89,0	49,0	-	15,00	PHP 44-14M-170TB
		200,54	45	6F	3535	197,74	212	35	90,0	187,0	49,0	89,0	49,0	-	16,00	PHP 45-14M-170TB
		213,90	48	6F	3535	211,00	227	35	90,0	187,0	49,0	89,0	49,0	-	19,00	PHP 48-14M-170TB
		222,82	50	6F	3535	220,02	246	35	90,0	187,0	49,0	89,0	49,0	-	23,80	PHP 50-14M-170TB
		249,55	56	6F	3535	247,00	263	35	90,0	187,0	49,0	89,0	49,0	-	28,50	PHP 56-14M-170TB
		267,38	60	6F	4040	264,59	281	40	100,0	187,0	42,5	114,0	42,5	-	34,80	PHP 60-14M-170TB
		285,21	64	6F	4040	282,00	298	40	100,0	187,0	42,5	114,0	42,5	230	41,00	PHP 64-14M-170TB
		320,86	72	7	4040	318,00	-	40	100,0	187,0	42,5	114,0	42,5	230	46,90	PHP 72-14M-170TB
		356,51	80	7	4040	354,00	-	40	100,0	187,0	42,5	114,0	42,5	230	48,00	PHP 80-14M-170TB
		401,07	90	7	4040	398,00	-	40	100,0	187,0	42,5	114,0	42,5	230	52,50	PHP 90-14M-170TB
		499,11	112	7	5050	496,00	-	70	125,0	187,0	30,0	127,0	30,0	242	74,50	PHP 112-14M-170TB
		641,71	144	8	5050	639,00	-	70	125,0	187,0	30,0	127,0	30,0	394	91,00	PHP 144-14M-170TB
		748,86	168	8	5050	746,00	-	70	125,0	187,0	30,0	127,0	30,0	394	116,00	PHP 168-14M-170TB
		855,62	192	8	5050	853,00	-	70	125,0	187,0	30,0	127,0	30,0	394	134,00	PHP 192-14M-170TB
		962,57	216	8	5050	960,00	-	70	125,0	187,0	30,0	127,0	30,0	394	146,50	PHP 216-14M-170TB

* Mass does not include bushings.

Classical timing pulleys

XL Pilot bore (RSB) | L Pilot bore (RSB)

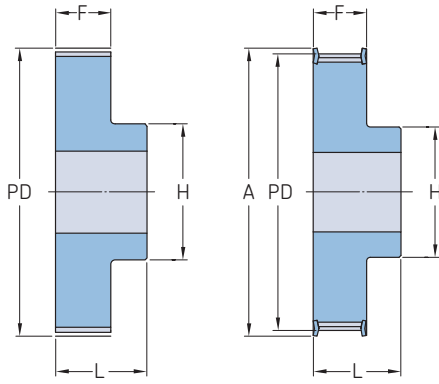

Type 1

Type 1F

Section	Belt width	Pitch diameter PD	Number of teeth	Pulley type	Dimensions							Mass	Designation
					Outer diameter OD	A	B Min.	Max.	H	F	L		
-	mm	-	-	mm							kg	-	
XL	6,4 and 9,5	16,17	10	1F	15,67	23	5	5	9,5	14,3	19,8	0,02	PHP 10XL037RSB
		17,79	11	1F	17,29	23	5	5	9,5	14,3	19,8	0,02	PHP 11XL037RSB
		19,40	12	1F	18,90	25	5	8	12,7	14,3	19,8	0,03	PHP 12XL037RSB
		21,02	13	1F	20,52	25	6	8	12,7	14,3	19,8	0,03	PHP 13XL037RSB
		22,64	14	1F	22,14	28	6	9	14,3	14,3	19,8	0,04	PHP 14XL037RSB
		24,26	15	1F	23,76	28	6	11	15,9	14,3	19,8	0,04	PHP 15XL037RSB
		25,87	16	1F	25,37	32	6	12	17,5	14,3	19,8	0,05	PHP 16XL037RSB
		27,49	17	1F	26,99	36	6	13	20,0	14,3	19,8	0,05	PHP 17XL037RSB
		29,11	18	1F	28,61	36	6	13	20,6	14,3	19,8	0,06	PHP 18XL037RSB
		30,72	19	1F	30,22	36	6	13	20,6	14,3	19,8	0,07	PHP 19XL037RSB
		32,34	20	1F	31,84	38	6	15	23,8	14,3	22,2	0,08	PHP 20XL037RSB
		33,96	21	1F	33,46	38	6	15	23,8	14,3	22,2	0,09	PHP 21XL037RSB
		35,57	22	1F	35,07	42	6	16	25,4	14,3	22,2	0,10	PHP 22XL037RSB
		38,81	24	1F	38,31	44	6	18	27,0	14,3	22,2	0,12	PHP 24XL037RSB
		42,04	26	1F	41,54	48	6	20	30,0	14,3	22,2	0,14	PHP 26XL037RSB
		43,66	27	1F	43,16	48	6	20	30,0	14,3	22,2	0,15	PHP 27XL037RSB
		45,28	28	1F	44,78	51	6	20	30,2	14,3	22,2	0,16	PHP 28XL037RSB
		46,89	29	1F	46,39	51	6	20	30,2	14,3	22,2	0,17	PHP 29XL037RSB
		48,51	30	1F	48,01	54	6	24	34,9	14,3	22,2	0,19	PHP 30XL037RSB
		51,74	32	1	51,24	57	8	25	40,0	14,3	25,4	0,11	PHP 32XL037RSB
		54,98	34	1	54,48	-	8	25	38,0	14,3	25,4	0,11	PHP 34XL037RSB
		56,60	35	1	56,10	-	8	25	38,0	14,3	25,4	0,12	PHP 35XL037RSB
		58,21	36	1	57,71	-	8	30	45,0	14,3	25,4	0,13	PHP 36XL037RSB
		61,45	38	1	60,95	-	8	30	45,0	14,3	25,4	0,15	PHP 38XL037RSB
		64,68	40	1	64,18	-	8	30	45,0	14,3	25,4	0,17	PHP 40XL037RSB
		67,91	42	1	67,41	-	8	30	45,0	14,3	25,4	0,20	PHP 42XL037RSB
		71,15	44	1	70,65	-	8	30	45,0	14,3	25,4	0,15	PHP 44XL037RSB
		72,77	45	1	72,27	-	8	30	45,0	14,3	25,4	0,15	PHP 45XL037RSB
		77,62	48	1	77,12	-	8	30	45,0	14,3	25,4	0,16	PHP 48XL037RSB
97,02	60	1	96,52	-	8	30	45,0	14,3	25,4	0,18	PHP 60XL037RSB		
116,43	72	1	115,93	-	8	30	45,0	14,3	25,4	0,23	PHP 72XL037RSB		
L	12,7	30,32	10	1F	29,56	36	6	14	22,0	19,0	26,0	0,11	PHP 10L050RSB
		33,35	11	1F	32,59	39	6	14	22,0	19,0	26,0	0,13	PHP 11L050RSB
		36,38	12	1F	35,62	42	6	20	28,0	19,0	30,0	0,19	PHP 12L050RSB
		39,41	13	1F	38,65	45	6	20	28,0	19,0	30,0	0,21	PHP 13L050RSB
		42,45	14	1F	41,69	48	8	20	28,0	19,0	30,0	0,23	PHP 14L050RSB
		45,48	15	1F	44,72	51	8	23	32,0	19,0	30,0	0,27	PHP 15L050RSB
		48,51	16	1F	47,75	54	8	24	36,0	19,0	32,0	0,34	PHP 16L050RSB
		51,54	17	1F	50,78	57	10	24	38,0	19,0	32,0	0,38	PHP 17L050RSB
		54,57	18	1F	53,81	60	10	27	40,0	19,0	32,0	0,41	PHP 18L050RSB
		57,61	19	1F	56,85	63	10	27	40,0	19,0	32,0	0,45	PHP 19L050RSB
		60,64	20	1F	59,88	66	10	30	46,0	19,0	32,0	0,50	PHP 20L050RSB
		63,67	21	1F	62,91	69	10	30	46,0	19,0	32,0	0,55	PHP 21L050RSB
		66,70	22	1F	65,94	72	10	33	50,0	19,0	32,0	0,62	PHP 22L050RSB
		69,73	23	1F	68,97	78	10	33	50,0	19,0	26,0	0,65	PHP 23L050RSB
		72,77	24	1F	72,01	78	12	33	50,0	19,0	26,0	0,68	PHP 24L050RSB
		75,80	25	1F	75,04	85	12	33	50,0	19,0	26,0	0,74	PHP 25L050RSB
		78,83	26	1F	78,07	85	12	33	50,0	19,0	26,0	0,82	PHP 26L050RSB
		81,86	27	1F	81,10	91	12	33	50,0	19,0	26,0	0,85	PHP 27L050RSB
		84,89	28	1F	84,13	91	12	33	50,0	19,0	26,0	0,92	PHP 28L050RSB
		87,93	29	1F	87,17	91	12	33	50,0	19,0	26,0	1,00	PHP 29L050RSB
		90,96	30	1F	90,20	97	12	33	50,0	19,0	26,0	1,10	PHP 30L050RSB
		93,99	31	1F	93,23	103	12	33	50,0	19,0	26,0	1,14	PHP 31L050RSB

All XL pulleys are made from aluminium with 2 set screws at 90°. Where keyway is required, reduce maximum bore by twice keyway depth.

Classical timing pulleys

L Pilot bore (RSB)

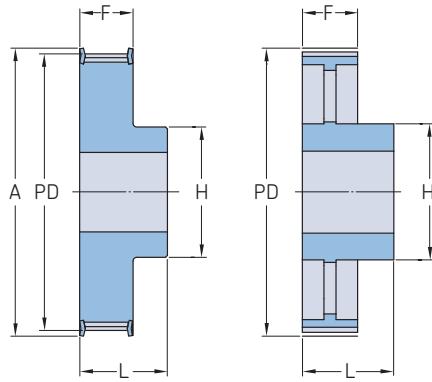

Type 1F

Type 5

Section	Belt width	Pitch diameter PD	Number of teeth	Pulley type	Dimensions						Mass	Designation	
					Outer diameter OD	A	B Min.	Max.	H	F			L
		mm	-	-	mm						kg	-	
L	12,7	97,02	32	1F	96,26	103	12	33	50,0	19,0	26,0	1,19	PHP 32L050RSB
		100,05	33	1F	99,29	106	12	33	50,0	19,0	26,0	1,25	PHP 33L050RSB
		103,08	34	1F	102,32	115	12	33	50,0	19,0	26,0	1,31	PHP 34L050RSB
		106,12	35	1F	105,36	115	12	33	50,0	19,0	26,0	1,37	PHP 35L050RSB
		109,15	36	1F	108,39	115	12	33	50,0	19,0	26,0	1,40	PHP 36L050RSB
		115,21	38	1F	114,45	127	12	33	50,0	19,0	26,0	1,22	PHP 38L050RSB
		121,28	40	1F	120,52	127	12	33	50,0	19,0	26,0	1,26	PHP 40L050RSB
		127,34	42	1F	126,58	139	12	33	50,0	19,0	26,0	1,31	PHP 42L050RSB
		133,40	44	1F	132,64	139	12	33	50,0	19,0	28,0	1,43	PHP 44L050RSB
		136,44	45	1F	135,68	152	12	33	50,0	19,0	28,0	1,49	PHP 45L050RSB
		145,53	48	1F	144,77	152	12	33	50,0	19,0	28,0	1,55	PHP 48L050RSB
		151,60	50	5	150,84	-	12	33	50,0	19,0	28,0	1,66	PHP 50L050RSB
		157,66	52	5	156,90	-	12	33	50,0	19,0	28,0	1,85	PHP 52L050RSB
		169,79	56	5	169,03	-	12	33	50,0	19,0	28,0	1,97	PHP 56L050RSB
		172,82	57	5	172,06	-	12	33	50,0	19,0	28,0	2,09	PHP 57L050RSB
		191,91	60	5	191,15	-	15	45	50,0	19,0	42,0	2,30	PHP 60L050RSB
		218,30	72	5	217,54	-	15	45	75,0	19,0	42,0	2,50	PHP 72L050RSB
		230,43	76	5	229,67	-	15	45	75,0	19,0	42,0	2,70	PHP 76L050RSB
		254,68	84	5	253,92	-	15	45	75,0	19,0	42,0	2,90	PHP 84L050RSB
		283,03	95	5	282,27	-	15	45	75,0	19,0	42,0	3,10	PHP 95L050RSB
291,06	96	5	290,30	-	15	45	75,0	19,0	42,0	3,30	PHP 96L050RSB		
L	19,1	30,32	10	1F	29,56	36	6	14	22,0	25,4	32,0	0,15	PHP 10L075RSB
		33,35	11	1F	32,59	39	6	14	22,0	25,4	32,0	0,20	PHP 11L075RSB
		36,38	12	1F	35,62	42	8	20	28,0	25,4	38,0	0,23	PHP 12L075RSB
		39,41	13	1F	38,65	45	8	20	28,0	25,4	38,0	0,26	PHP 13L075RSB
		42,45	14	1F	41,69	48	8	20	28,0	25,4	38,0	0,28	PHP 14L075RSB
		45,48	15	1F	44,72	51	8	23	32,0	25,4	38,0	0,36	PHP 15L075RSB
		48,51	16	1F	47,75	54	8	24	36,0	25,4	41,0	0,45	PHP 16L075RSB
		51,54	17	1F	50,78	57	10	24	38,0	25,4	41,0	0,50	PHP 17L075RSB
		54,57	18	1F	53,81	60	10	27	40,0	25,4	41,0	0,55	PHP 18L075RSB
		57,61	19	1F	56,85	63	10	27	40,0	25,4	41,0	0,60	PHP 19L075RSB
		60,64	20	1F	59,88	66	10	30	46,0	25,4	41,0	0,65	PHP 20L075RSB
		63,67	21	1F	62,91	69	10	30	46,0	25,4	41,0	0,70	PHP 21L075RSB
		66,70	22	1F	65,94	72	10	33	50,0	25,4	41,0	0,75	PHP 22L075RSB
		69,73	23	1F	68,97	78	10	33	50,0	25,4	32,0	0,81	PHP 23L075RSB
		72,77	24	1F	72,01	79	12	33	50,0	25,4	32,0	0,85	PHP 24L075RSB
		75,80	25	1F	75,04	85	12	33	50,0	25,4	32,0	0,94	PHP 25L075RSB
		78,83	26	1F	78,07	85	12	33	50,0	25,4	32,0	1,02	PHP 26L075RSB
		81,86	27	1F	81,10	91	12	33	50,0	25,4	32,0	1,09	PHP 27L075RSB
		84,89	28	1F	84,13	91	12	33	50,0	25,4	32,0	1,20	PHP 28L075RSB
		87,93	29	1F	87,17	91	12	33	50,0	25,4	32,0	1,33	PHP 29L075RSB
		90,96	30	1F	90,20	97	12	33	50,0	25,4	32,0	1,33	PHP 30L075RSB
		93,99	31	1F	93,23	103	12	33	50,0	25,4	32,0	1,39	PHP 31L075RSB
		97,02	32	1F	96,26	103	12	33	50,0	25,4	32,0	1,45	PHP 32L075RSB
		100,05	33	1F	99,29	106	12	33	50,0	25,4	32,0	1,56	PHP 33L075RSB
		103,08	34	1F	102,32	115	12	33	50,0	25,4	32,0	1,70	PHP 34L075RSB
		106,12	35	1F	105,36	115	12	33	50,0	25,4	32,0	1,78	PHP 35L075RSB
		109,15	36	1F	108,39	115	12	36	55,0	25,4	32,0	1,50	PHP 36L075RSB
		115,21	38	1F	114,45	127	12	36	55,0	25,4	32,0	1,63	PHP 38L075RSB
		121,28	40	1F	120,52	127	12	40	60,0	25,4	32,0	1,79	PHP 40L075RSB
		127,34	42	1F	126,58	139	12	40	60,0	25,4	32,0	1,95	PHP 42L075RSB
		133,40	44	1F	132,64	139	12	40	60,0	25,4	35,0	2,05	PHP 44L075RSB
		136,44	45	1F	135,68	152	12	40	60,0	25,4	35,0	2,10	PHP 45L075RSB

Classical timing pulleys

L Pilot bore (RSB) | H Pilot bore (RSB)

Section	Belt width	Pitch diameter	Number of teeth	Pulley type	Dimensions						Mass	Designation		
					Outer diameter OD	A	B Min.	Max.	H	F			L	
-	mm	PD	-	-	mm						kg	-		
L	19,1	145,53	48	1F	144,77	152	12	40	60,0	25,4	35,0	2,15	PHP 48L075RSB	
		151,60	50	5	150,84	-	12	40	60,0	25,4	35,0	2,25	PHP 50L075RSB	
		157,66	52	5	156,90	-	12	40	60,0	25,4	35,0	2,55	PHP 52L075RSB	
		169,79	56	5	169,03	-	12	40	60,0	25,4	35,0	2,78	PHP 56L075RSB	
		172,82	57	5	172,06	-	12	40	60,0	25,4	35,0	2,91	PHP 57L075RSB	
		181,91	60	5	181,15	-	15	45	75,0	25,4	45,0	3,10	PHP 60L075RSB	
		218,30	72	5	217,54	-	15	45	75,0	25,4	45,0	3,29	PHP 72L075RSB	
		230,43	76	5	229,67	-	15	45	75,0	25,4	45,0	3,48	PHP 76L075RSB	
		254,67	84	5	253,91	-	15	45	75,0	25,4	45,0	3,67	PHP 84L075RSB	
		283,03	95	5	282,27	-	15	45	75,0	25,4	45,0	3,76	PHP 95L075RSB	
		291,06	96	5	290,30	-	15	45	75,0	25,4	45,0	3,85	PHP 96L075RSB	
		363,83	120	5	363,07	-	15	70	120,0	25,4	45,0	4,50	PHP 120L075RSB	
	L	25,4	30,32	10	1F	29,56	36	6	14	22,0	32,0	38,0	0,18	PHP 10L100RSB
			33,35	11	1F	32,59	39	6	14	22,0	32,0	38,0	0,20	PHP 11L100RSB
			36,38	12	1F	35,62	42	8	20	28,0	32,0	45,0	0,25	PHP 12L100RSB
			39,41	13	1F	38,65	45	8	20	28,0	32,0	45,0	0,30	PHP 13L100RSB
			42,45	14	1F	41,69	48	8	20	28,0	32,0	45,0	0,34	PHP 14L100RSB
			45,48	15	1F	44,72	51	8	23	32,0	32,0	45,0	0,40	PHP 15L100RSB
			48,51	16	1F	47,75	54	8	24	36,0	32,0	45,0	0,48	PHP 16L100RSB
			51,54	17	1F	50,78	57	10	24	38,0	32,0	45,0	0,57	PHP 17L100RSB
			54,57	18	1F	53,81	60	10	27	40,0	32,0	45,0	0,62	PHP 18L100RSB
			57,61	19	1F	56,85	63	10	27	40,0	32,0	45,0	0,69	PHP 19L100RSB
			60,64	20	1F	59,88	66	10	30	46,0	32,0	45,0	0,76	PHP 20L100RSB
			63,67	21	1F	62,91	69	10	30	46,0	32,0	45,0	0,82	PHP 21L100RSB
66,70			22	1F	65,94	72	10	33	50,0	32,0	45,0	0,92	PHP 22L100RSB	
69,73			23	1F	68,97	78	10	33	50,0	32,0	38,0	0,98	PHP 23L100RSB	
72,77			24	1F	72,01	78	12	33	50,0	32,0	38,0	1,06	PHP 24L100RSB	
75,80			25	1F	75,04	85	12	33	50,0	32,0	38,0	1,14	PHP 25L100RSB	
78,83			26	1F	78,07	85	12	33	50,0	32,0	38,0	1,24	PHP 26L100RSB	
81,86			27	1F	81,10	91	12	33	50,0	32,0	38,0	1,33	PHP 27L100RSB	
84,89			28	1F	84,13	91	12	33	50,0	32,0	38,0	1,40	PHP 28L100RSB	
87,93			29	1F	87,17	91	12	33	50,0	32,0	38,0	1,70	PHP 29L100RSB	
90,96			30	1F	90,20	97	12	33	50,0	32,0	38,0	1,70	PHP 30L100RSB	
97,02			32	1F	96,26	103	12	33	50,0	32,0	38,0	1,80	PHP 32L100RSB	
100,05			33	1F	99,29	106	12	33	50,0	32,0	38,0	1,92	PHP 33L100RSB	
103,08			34	1F	102,32	115	12	33	50,0	32,0	38,0	2,09	PHP 34L100RSB	
106,12		35	1F	105,36	115	12	33	50,0	32,0	38,0	2,19	PHP 35L100RSB		
109,15		36	1F	108,39	115	12	36	55,0	32,0	32,0	1,50	PHP 36L100RSB		
115,21		38	1F	114,45	127	12	36	55,0	32,0	32,0	1,77	PHP 38L100RSB		
121,28		40	1F	120,52	127	12	40	60,0	32,0	32,0	1,90	PHP 40L100RSB		
127,34		42	1F	126,58	139	12	40	60,0	32,0	32,0	2,11	PHP 42L100RSB		
133,40		44	1F	132,64	139	12	40	60,0	32,0	35,0	2,30	PHP 44L100RSB		
136,44		45	1F	135,68	152	12	40	60,0	32,0	35,0	2,40	PHP 45L100RSB		
145,53		48	1F	144,77	152	12	40	60,0	32,0	35,0	2,49	PHP 48L100RSB		
151,60		50	5	150,84	-	12	40	60,0	32,0	35,0	2,68	PHP 50L100RSB		
157,66		52	5	156,90	-	12	40	60,0	32,0	35,0	2,87	PHP 52L100RSB		
169,79		56	5	169,03	-	12	40	60,0	32,0	35,0	3,06	PHP 56L100RSB		
172,82		57	5	172,06	-	12	40	60,0	32,0	35,0	3,25	PHP 57L100RSB		
191,91		60	5	191,15	-	15	45	75,0	32,0	45,0	3,44	PHP 60L100RSB		
218,30		72	5	217,54	-	15	45	75,0	32,0	45,0	3,63	PHP 72L100RSB		
230,43		76	5	229,67	-	15	45	75,0	32,0	45,0	3,82	PHP 76L100RSB		
254,68		84	5	253,92	-	15	45	75,0	32,0	45,0	4,01	PHP 84L100RSB		
283,03		95	5	282,27	-	15	45	75,0	32,0	45,0	4,11	PHP 95L100RSB		
291,06		96	5	290,30	-	15	45	75,0	32,0	45,0	4,20	PHP 96L100RSB		
363,83		120	5	363,07	-	15	70	120,0	32,0	45,0	5,00	PHP 120L100RSB		
H		19,1	56,60	14	1F	55,23	63	10	27	40,0	27,0	40,0	0,50	PHP 14H075RSB
			60,64	15	1F	59,27	67	10	30	46,0	27,0	40,0	0,55	PHP 15H075RSB
			64,68	16	1F	63,31	71	10	30	45,0	27,0	40,0	0,60	PHP 16H075RSB
			68,72	17	1F	67,35	75	10	30	46,0	27,0	40,0	0,70	PHP 17H075RSB
			72,77	18	1F	71,40	79	12	36	55,0	27,0	40,0	0,80	PHP 18H075RSB
	76,81		19	1F	75,44	83	12	40	60,0	27,0	40,0	1,00	PHP 19H075RSB	
	80,85		20	1F	79,48	87	12	41	62,0	27,0	40,0	1,10	PHP 20H075RSB	
	84,89		21	1F	83,52	91	12	43	67,0	27,0	40,0	1,20	PHP 21H075RSB	
	88,94		22	1F	87,57	95	12	45	70,0	27,0	40,0	1,40	PHP 22H075RSB	
	92,98		23	1F	91,61	98	12	46	72,0	27,0	40,0	1,50	PHP 23H075RSB	
	97,02		24	1F	95,65	103	12	47	75,0	27,0	40,0	1,60	PHP 24H075RSB	
	101,06		25	1F	99,69	107	12	47	75,0	27,0	40,0	1,70	PHP 25H075RSB	
	105,11	26	1F	103,74	111	15	54	80,0	27,0	40,0	1,80	PHP 26H075RSB		
	109,15	27	1F	107,78	115	15	54	80,0	27,0	40,0	1,90	PHP 27H075RSB		
	113,19	28	1F	111,82	119	15	54	80,0	27,0	40,0	2,00	PHP 28H075RSB		
	117,23	29	1F	115,86	123	15	54	80,0	27,0	40,0	2,05	PHP 29H075RSB		
	121,28	30	1F	119,91	127	15	54	80,0	27,0	40,0	2,10	PHP 30H075RSB		
	125,32	31	1F	123,95	131	15	54	80,0	27,0	40,0	2,15	PHP 31H075RSB		

Classical timing pulleys

H Pilot bore (RSB)

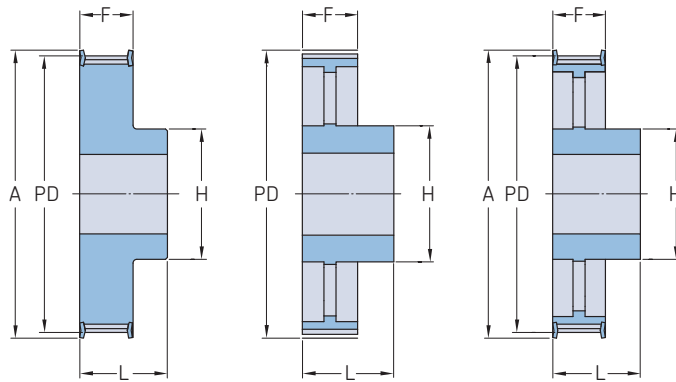

Type 1F

Type 5

Type 5F

Section	Belt width	Pitch diameter PD	Number of teeth	Pulley type	Dimensions Outer diameter OD	Dimensions					Mass	Designation		
						A	B Min.	Max.	H	F			L	
		mm	-	-	mm						kg	-		
H	19,1	129,36	32	1F	127,99	135	15	54	80,0	27,0	40,0	2,20	PHP 32H075RSB	
		133,40	33	1F	132,03	142	15	54	80,0	27,0	40,0	2,25	PHP 33H075RSB	
		137,45	34	1F	136,08	142	15	54	80,0	27,0	40,0	2,30	PHP 34H075RSB	
		141,49	35	1F	140,12	151	15	54	80,0	27,0	40,0	2,35	PHP 35H075RSB	
		145,53	36	1F	144,16	151	20	54	80,0	27,0	40,0	2,40	PHP 36H075RSB	
		153,62	38	1F	152,25	158	20	54	80,0	27,0	40,0	2,60	PHP 38H075RSB	
	161,70	40	1F	160,33	168	20	54	80,0	27,0	40,0	2,80	PHP 40H075RSB		
	169,79	42	1F	168,42	184	20	54	80,0	27,0	40,0	2,90	PHP 42H075RSB		
	177,87	44	5F	176,50	184	20	48	80,0	27,0	40,0	2,70	PHP 44H075RSB		
	181,91	45	5F	180,54	192	20	54	90,0	27,0	45,0	2,85	PHP 45H075RSB		
	194,04	48	5F	192,67	200	20	54	90,0	27,0	45,0	3,00	PHP 48H075RSB		
	202,13	50	5	200,76	-	20	54	90,0	27,0	45,0	3,25	PHP 50H075RSB		
	H	19,1 and 25,4	56,60	14	1F	55,23	63	10	27	40,0	33,3	45,0	0,65	PHP 14H100RSB
			60,64	15	1F	59,27	67	10	30	46,0	33,3	45,0	0,75	PHP 15H100RSB
			64,67	16	1F	63,30	71	10	30	46,0	33,3	45,0	0,85	PHP 16H100RSB
			68,72	17	1F	67,35	75	10	30	46,0	33,3	45,0	0,97	PHP 17H100RSB
			72,77	18	1F	71,40	79	12	30	55,0	33,3	45,0	1,10	PHP 18H100RSB
			76,81	19	1F	75,44	83	12	36	60,0	33,3	45,0	1,20	PHP 19H100RSB
80,85			20	1F	79,48	87	12	41	62,0	33,3	45,0	1,40	PHP 20H100RSB	
84,89			21	1F	83,52	91	12	43	67,0	33,3	45,0	1,60	PHP 21H100RSB	
88,94			22	1F	87,57	95	12	45	70,0	33,3	45,0	1,70	PHP 22H100RSB	
92,98			23	1F	91,61	98	12	46	72,0	33,3	45,0	1,83	PHP 23H100RSB	
97,03			24	1F	95,66	103	12	47	75,0	33,3	45,0	1,95	PHP 24H100RSB	
101,06			25	1F	99,69	107	12	47	75,0	33,3	45,0	2,19	PHP 25H100RSB	
105,11			26	1F	103,74	111	15	54	80,0	33,3	45,0	2,43	PHP 26H100RSB	
109,15			27	1F	107,78	115	15	54	80,0	33,3	45,0	2,57	PHP 27H100RSB	
113,18			28	1F	111,81	119	15	54	80,0	33,3	45,0	2,70	PHP 28H100RSB	
117,23			29	1F	115,86	123	15	54	80,0	33,3	45,0	2,95	PHP 29H100RSB	
121,29			30	1F	119,92	127	15	54	80,0	33,3	45,0	3,20	PHP 30H100RSB	
125,32			31	1F	123,95	131	15	54	80,0	33,3	45,0	3,35	PHP 31H100RSB	
129,36		32	1F	127,99	135	20	54	80,0	33,3	45,0	3,50	PHP 32H100RSB		
133,40		33	1F	132,03	142	20	54	80,0	33,3	45,0	3,78	PHP 33H100RSB		
137,45		34	1F	136,08	142	20	54	80,0	33,3	45,0	4,05	PHP 34H100RSB		
141,49		35	1F	140,12	151	20	54	80,0	33,3	45,0	4,35	PHP 35H100RSB		
145,53		36	1F	144,16	151	20	54	80,0	33,3	45,0	4,65	PHP 36H100RSB		
153,62		38	1F	152,25	158	20	54	80,0	33,3	45,0	4,98	PHP 38H100RSB		
161,70		40	1F	160,33	168	20	54	80,0	33,3	45,0	5,30	PHP 40H100RSB		
169,79		42	1F	168,42	184	20	54	80,0	33,3	45,0	5,50	PHP 42H100RSB		
177,87		44	5F	176,50	184	20	48	80,0	33,3	50,0	4,00	PHP 44H100RSB		
181,91		45	5F	180,54	192	20	54	80,0	33,3	50,0	4,25	PHP 45H100RSB		
194,03		48	5F	192,66	200	20	54	90,0	33,3	50,0	4,50	PHP 48H100RSB		
202,13		50	5	200,76	-	20	54	90,0	33,3	50,0	4,94	PHP 50H100RSB		
210,21	52	5	208,84	-	20	54	90,0	33,3	50,0	5,38	PHP 52H100RSB			
230,42	57	5	229,05	-	20	54	90,0	33,3	50,0	5,82	PHP 57H100RSB			
234,47	58	5	233,10	-	20	54	90,0	33,3	50,0	5,82	PHP 58H100RSB			
242,55	60	5	241,18	-	20	70	120,0	33,3	50,0	6,25	PHP 60H100RSB			
282,98	70	5	281,61	-	20	70	120,0	33,3	55,0	7,55	PHP 70H100RSB			
291,06	72	5	289,69	-	20	70	120,0	33,3	55,0	8,85	PHP 72H100RSB			
307,23	76	5	305,86	-	20	70	120,0	33,3	55,0	9,43	PHP 76H100RSB			
339,57	84	5	338,20	-	20	70	120,0	33,3	55,0	10,00	PHP 84H100RSB			
388,08	96	5	386,71	-	24	70	120,0	33,3	60,0	10,48	PHP 96H100RSB			
485,10	120	5	483,73	-	24	70	120,0	33,3	60,0	13,10	PHP 120H100RSB			
630,63	156	5	629,26	-	24	70	130,0	33,3	60,0	17,20	PHP 156H100RSB			

Classical timing pulleys

H Pilot bore (RSB)

Section	Belt width	Pitch diameter	Number of teeth	Pulley type	Dimensions							Mass	Designation		
					Outer diameter OD	A	B Min.	Max.	H	F	L				
-	mm	PD	-	-	mm							kg	-		
H	38,1	56,60	14	1F	55,23	63	12	27	40,0	46,0	58,0	0,82	PHP 14H150RSB		
		60,64	15	1F	59,27	67	12	30	46,0	46,0	58,0	0,96	PHP 15H150RSB		
		64,67	16	1F	63,30	71	12	30	46,0	46,0	58,0	1,10	PHP 16H150RSB		
		68,72	17	1F	67,35	75	12	30	46,0	46,0	58,0	1,30	PHP 17H150RSB		
		72,77	18	1F	71,40	79	12	30	55,0	46,0	58,0	1,50	PHP 18H150RSB		
		76,81	19	1F	75,44	83	12	36	60,0	46,0	58,0	1,70	PHP 19H150RSB		
		80,85	20	1F	79,48	87	12	41	62,0	46,0	58,0	1,80	PHP 20H150RSB		
		84,89	21	1F	83,52	91	12	43	67,0	46,0	58,0	2,20	PHP 21H150RSB		
		88,94	22	1F	87,57	95	12	45	70,0	46,0	58,0	2,30	PHP 22H150RSB		
		92,98	23	1F	91,61	98	12	46	72,0	46,0	58,0	2,45	PHP 23H150RSB		
		97,03	24	1F	95,66	103	12	47	75,0	46,0	58,0	2,60	PHP 24H150RSB		
		101,06	25	1F	99,69	107	12	47	75,0	46,0	58,0	2,90	PHP 25H150RSB		
		105,11	26	1F	103,74	111	15	54	80,0	46,0	58,0	3,20	PHP 26H150RSB		
		109,15	27	1F	107,78	115	15	54	80,0	46,0	58,0	3,30	PHP 27H150RSB		
		113,18	28	1F	111,81	119	15	54	80,0	46,0	58,0	3,39	PHP 28H150RSB		
		117,23	29	1F	115,86	123	15	54	80,0	46,0	58,0	3,75	PHP 29H150RSB		
		121,29	30	1F	119,92	127	15	54	80,0	46,0	58,0	4,10	PHP 30H150RSB		
		125,32	31	1F	123,95	131	15	54	80,0	46,0	58,0	4,43	PHP 31H150RSB		
		129,36	32	1F	127,99	135	20	54	80,0	46,0	58,0	4,77	PHP 32H150RSB		
		133,40	33	1F	132,03	142	20	54	80,0	46,0	58,0	5,08	PHP 33H150RSB		
		137,45	34	1F	136,08	142	20	54	80,0	46,0	58,0	5,40	PHP 34H150RSB		
		141,49	35	1F	140,12	151	20	54	80,0	46,0	58,0	5,71	PHP 35H150RSB		
		145,53	36	1F	144,16	151	20	54	80,0	46,0	58,0	6,02	PHP 36H150RSB		
		153,62	38	1F	152,25	158	20	54	80,0	46,0	58,0	6,76	PHP 38H150RSB		
		161,70	40	1F	160,33	168	20	54	80,0	46,0	58,0	7,50	PHP 40H150RSB		
		169,79	42	1F	168,42	184	20	54	80,0	46,0	58,0	8,00	PHP 42H150RSB		
		177,87	44	5F	176,50	184	20	48	80,0	46,0	58,0	5,00	PHP 44H150RSB		
		181,91	45	5F	180,54	192	20	48	80,0	46,0	58,0	5,05	PHP 45H150RSB		
		194,03	48	5F	192,66	200	20	54	90,0	46,0	65,0	5,10	PHP 48H150RSB		
		202,13	50	5	200,76	-	20	54	90,0	46,0	65,0	5,75	PHP 50H150RSB		
		210,21	52	5	208,84	-	20	54	90,0	46,0	65,0	6,40	PHP 52H150RSB		
		230,43	57	5	229,06	-	20	54	90,0	46,0	65,0	6,75	PHP 57H150RSB		
		234,47	58	5	233,10	-	20	54	90,0	46,0	65,0	7,05	PHP 58H150RSB		
		242,55	60	5	241,18	-	20	70	120,0	46,0	65,0	7,70	PHP 60H150RSB		
		282,98	70	5	281,61	-	20	70	120,0	46,0	65,0	8,20	PHP 70H150RSB		
		291,06	72	5	289,69	-	20	70	120,0	46,0	65,0	8,70	PHP 72H150RSB		
		307,23	76	5	305,86	-	20	70	120,0	46,0	65,0	9,67	PHP 76H150RSB		
		339,57	84	5	338,20	-	20	70	120,0	46,0	65,0	10,64	PHP 84H150RSB		
		388,08	96	5	386,71	-	24	70	120,0	46,0	65,0	13,40	PHP 96H150RSB		
		485,10	120	5	483,73	-	24	70	120,0	46,0	65,0	15,70	PHP 120H150RSB		
		630,63	156	5	629,26	-	24	70	130,0	46,0	65,0	19,10	PHP 156H150RSB		
		H	50,8	56,60	14	1F	55,23	63	12	27	40,0	59,5	70,0	1,25	PHP 14H200RSB
				60,64	15	1F	59,27	67	12	30	46,0	59,5	70,0	1,33	PHP 15H200RSB
				64,67	16	1F	63,30	71	12	30	46,0	59,5	70,0	1,40	PHP 16H200RSB
				68,72	17	1F	67,35	75	12	30	46,0	59,5	70,0	1,67	PHP 17H200RSB
				72,77	18	1F	71,40	79	12	30	55,0	59,5	70,0	1,94	PHP 18H200RSB
				76,81	19	1F	75,44	83	12	36	60,0	59,5	70,0	2,18	PHP 19H200RSB
				80,85	20	1F	79,48	87	12	41	62,0	59,5	70,0	2,43	PHP 20H200RSB
				84,89	21	1F	83,52	91	12	43	67,0	59,5	70,0	2,60	PHP 21H200RSB
				88,94	22	1F	87,57	95	12	45	70,0	59,5	70,0	2,80	PHP 22H200RSB
92,98	23			1F	91,61	98	12	46	72,0	59,5	70,0	2,89	PHP 23H200RSB		
97,03	24			1F	95,66	103	12	47	75,0	59,5	70,0	2,97	PHP 24H200RSB		
101,06	25			1F	99,69	107	12	47	75,0	59,5	70,0	2,89	PHP 25H200RSB		
105,11	26			1F	103,74	111	15	54	80,0	59,5	70,0	3,90	PHP 26H200RSB		
109,15	27			1F	107,78	115	15	54	80,0	59,5	70,0	3,44	PHP 27H200RSB		
113,18	28			1F	111,81	119	15	54	80,0	59,5	70,0	4,60	PHP 28H200RSB		
117,23	29			1F	115,86	123	15	54	80,0	59,5	70,0	4,80	PHP 29H200RSB		
121,29	30			1F	119,92	127	15	54	80,0	59,5	70,0	5,00	PHP 30H200RSB		
125,32	31			1F	123,95	131	15	54	80,0	59,5	70,0	5,47	PHP 31H200RSB		
129,36	32			1F	127,99	135	20	54	80,0	59,5	70,0	5,93	PHP 32H200RSB		
133,40	33			1F	132,03	142	20	54	80,0	59,5	70,0	6,33	PHP 33H200RSB		
137,45	34			1F	136,08	142	20	54	80,0	59,5	70,0	6,73	PHP 34H200RSB		
141,49	35			1F	140,12	151	20	54	80,0	59,5	70,0	7,13	PHP 35H200RSB		
145,53	36			1F	144,16	151	20	54	80,0	59,5	70,0	7,53	PHP 36H200RSB		
153,62	38			1F	152,25	158	20	54	80,0	59,5	70,0	8,32	PHP 38H200RSB		
161,70	40			1F	160,33	168	20	54	80,0	59,5	70,0	9,11	PHP 40H200RSB		
169,79	42			1F	168,42	184	20	54	80,0	59,5	70,0	9,70	PHP 42H200RSB		
177,87	44			5F	176,50	184	20	48	80,0	59,5	70,0	5,00	PHP 44H200RSB		
181,91	45			5F	180,54	192	20	48	80,0	59,5	70,0	5,37	PHP 45H200RSB		
194,03	48			5F	192,66	200	20	54	90,0	59,5	75,0	5,73	PHP 48H200RSB		
202,13	50			5	200,76	-	20	54	90,0	59,5	75,0	6,62	PHP 50H200RSB		
210,21	52			5	208,84	-	20	54	90,0	59,5	75,0	7,50	PHP 52H200RSB		
230,43	57			5	229,06	-	20	54	90,0	59,5	75,0	8,76	PHP 57H200RSB		

Classical timing pulleys

H Pilot bore (RSB) | XH Pilot bore (RSB)

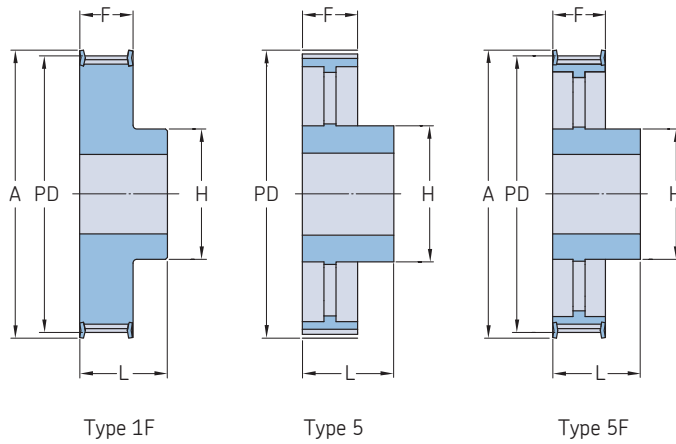

Section	Belt width	Pitch diameter PD	Number of teeth	Pulley type	Dimensions						Mass	Designation	
					Outer diameter OD	A	B Min.	Max.	H	F			L
		mm	-	-	mm						kg	-	
H	50,8	234,47	58	5	233,10	-	20	54	90,0	59,5	75,0	8,39	PHP 58H200RSB
		242,55	60	5	241,18	-	20	70	120,0	59,5	75,0	9,27	PHP 60H200RSB
		282,98	70	5	281,61	-	20	70	120,0	59,5	75,0	9,80	PHP 70H200RSB
		291,06	72	5	289,69	-	20	70	120,0	59,5	75,0	10,32	PHP 72H200RSB
		307,23	76	5	305,86	-	20	70	120,0	59,5	75,0	11,41	PHP 76H200RSB
		339,57	84	5	338,20	-	20	70	120,0	59,5	75,0	12,50	PHP 84H200RSB
		388,08	96	5	386,71	-	24	70	120,0	59,5	75,0	14,00	PHP 96H200RSB
		485,10	120	5	483,73	-	24	70	120,0	59,5	75,0	18,10	PHP 120H200RSB
		630,63	156	5	629,26	-	24	70	130,0	59,5	75,0	22,00	PHP 156H200RSB
		56,60	14	1F	55,23	63	14	27	40,0	85,5	100,0	1,80	PHP 14H300RSB
		60,64	15	1F	59,27	67	14	30	46,0	85,5	100,0	1,90	PHP 15H300RSB
		64,67	16	1F	63,30	71	14	30	46,0	85,5	100,0	2,00	PHP 16H300RSB
		68,72	17	1F	67,35	75	14	30	46,0	85,5	100,0	2,24	PHP 17H300RSB
		72,77	18	1F	71,40	79	14	30	55,0	85,5	100,0	2,47	PHP 18H300RSB
		76,81	19	1F	75,44	83	14	36	60,0	85,5	100,0	2,90	PHP 19H300RSB
80,85	20	1F	79,48	87	15	41	62,0	85,5	100,0	3,20	PHP 20H300RSB		
84,89	21	1F	83,52	91	15	43	67,0	85,5	100,0	3,60	PHP 21H300RSB		
88,94	22	1F	87,57	95	15	45	70,0	85,5	100,0	4,00	PHP 22H300RSB		
92,98	23	1F	91,61	98	15	46	72,0	85,5	100,0	4,35	PHP 23H300RSB		
97,03	24	1F	95,66	103	15	47	75,0	85,5	100,0	4,70	PHP 24H300RSB		
101,06	25	1F	99,69	107	15	47	75,0	85,5	100,0	5,24	PHP 25H300RSB		
105,11	26	1F	103,74	111	15	54	80,0	85,5	100,0	5,78	PHP 26H300RSB		
109,15	27	1F	107,78	115	15	54	80,0	85,5	100,0	6,16	PHP 27H300RSB		
113,18	28	1F	111,81	119	15	54	80,0	85,5	100,0	6,54	PHP 28H300RSB		
117,23	29	1F	115,86	123	15	54	80,0	85,5	100,0	6,77	PHP 29H300RSB		
121,29	30	1F	119,92	127	15	54	80,0	85,5	100,0	7,00	PHP 30H300RSB		
125,32	31	1F	123,95	131	15	54	80,0	85,5	100,0	7,83	PHP 31H300RSB		
129,36	32	1F	127,99	135	20	54	80,0	85,5	100,0	8,66	PHP 32H300RSB		
133,40	33	1F	132,03	142	20	54	80,0	85,5	100,0	9,23	PHP 33H300RSB		
137,45	34	1F	136,08	142	20	54	80,0	85,5	100,0	9,79	PHP 34H300RSB		
141,47	35	1F	140,10	151	20	54	80,0	85,5	100,0	10,36	PHP 35H300RSB		
145,53	36	1F	144,16	151	20	54	80,0	85,5	100,0	10,92	PHP 36H300RSB		
153,62	38	1F	152,25	158	20	54	80,0	85,5	100,0	12,20	PHP 38H300RSB		
161,70	40	1F	160,33	168	20	54	80,0	85,5	100,0	13,50	PHP 40H300RSB		
169,79	42	1F	168,42	184	20	54	80,0	85,5	100,0	14,50	PHP 42H300RSB		
177,87	44	5F	176,50	184	20	48	80,0	85,5	100,0	8,06	PHP 44H300RSB		
194,03	48	5F	192,66	200	20	54	90,0	85,5	100,0	9,67	PHP 48H300RSB		
202,13	50	5	200,76	-	20	54	90,0	85,5	100,0	10,87	PHP 50H300RSB		
230,43	57	5	229,06	-	20	54	90,0	85,5	100,0	11,92	PHP 57H300RSB		
234,47	58	5	233,10	-	20	54	90,0	85,5	100,0	12,07	PHP 58H300RSB		
242,55	60	5	241,18	-	20	70	120,0	85,5	100,0	13,30	PHP 60H300RSB		
291,06	72	5	289,69	-	20	70	120,0	85,5	100,0	15,70	PHP 72H300RSB		
307,24	76	5	305,87	-	20	70	120,0	85,5	100,0	16,17	PHP 76H300RSB		
339,57	84	5	338,20	-	20	70	120,0	85,5	100,0	17,10	PHP 84H300RSB		
388,09	96	5	386,72	-	24	70	120,0	85,5	100,0	20,40	PHP 96H300RSB		
485,12	120	5	483,75	-	24	70	120,0	85,5	100,0	27,80	PHP 120H300RSB		
630,63	156	5	629,26	-	24	70	130,0	85,5	100,0	35,00	PHP 156H300RSB		
XH	50,8	127,34	18	1F	124,54	141	24	67	100,0	65,1	80,0	5,00	PHP 18XH200RSB
		134,41	19	1F	131,61	146	24	67	100,0	65,1	80,0	5,50	PHP 19XH200RSB
		141,49	20	1F	138,69	155	24	67	100,0	65,1	80,0	6,00	PHP 20XH200RSB
		148,56	21	1F	145,76	169	24	73	110,0	65,1	80,0	6,60	PHP 21XH200RSB
		155,64	22	1F	152,84	169	24	73	110,0	65,1	80,0	7,20	PHP 22XH200RSB
		169,79	24	1F	166,99	183	24	80	120,0	65,1	80,0	8,60	PHP 24XH200RSB

Classical timing pulleys

XH Pilot bore (RSB)

Section	Belt width	Pitch diameter	Number of teeth	Pulley type	Dimensions						Mass	Designation			
					Outer diameter OD	A	B Min.	Max.	H	F			L		
-	mm	PD	-	-	mm						kg	-			
XH	50,8	176,86	25	1F	174,06	198	24	80	120,0	65,1	80,0	9,40	PHP 25XH200RSB		
		183,93	26	1F	181,13	198	24	80	120,0	65,1	80,0	9,70	PHP 26XH200RSB		
		191,01	27	1F	188,21	212	24	80	120,0	65,1	80,0	9,90	PHP 27XH200RSB		
		198,09	28	1F	195,29	212	24	80	120,0	65,1	80,0	10,00	PHP 28XH200RSB		
		212,23	30	1F	209,43	226	24	80	120,0	65,1	80,0	10,40	PHP 30XH200RSB		
		226,38	32	1F	223,58	240	24	80	120,0	65,1	80,0	11,20	PHP 32XH200RSB		
		240,53	34	1F	237,73	256	24	80	120,0	65,1	80,0	12,60	PHP 34XH200RSB		
		268,83	38	5	266,03	-	28	100	150,0	65,1	80,0	14,60	PHP 38XH200RSB		
		282,98	40	5	280,18	-	28	100	150,0	65,1	100,0	16,00	PHP 40XH200RSB		
		339,57	48	5	336,77	-	28	100	150,0	65,1	100,0	18,40	PHP 48XH200RSB		
		424,47	60	5	421,67	-	28	100	150,0	65,1	100,0	24,30	PHP 60XH200RSB		
		XH	76,2	127,34	18	1F	124,54	141	28	67	100,0	92,1	110,0	6,80	PHP 18XH300RSB
				134,41	19	1F	131,61	146	28	67	100,0	92,1	110,0	7,10	PHP 19XH300RSB
				141,49	20	1F	138,69	155	28	67	100,0	92,1	110,0	7,40	PHP 20XH300RSB
				148,56	21	1F	145,76	169	28	73	110,0	92,1	110,0	8,20	PHP 21XH300RSB
155,64	22			1F	152,84	169	28	73	110,0	92,1	110,0	9,00	PHP 22XH300RSB		
169,79	24			1F	166,99	183	28	80	120,0	92,1	110,0	10,60	PHP 24XH300RSB		
176,86	25			1F	174,06	198	28	80	120,0	92,1	110,0	11,80	PHP 25XH300RSB		
183,93	26			1F	181,13	198	28	80	120,0	92,1	110,0	12,00	PHP 26XH300RSB		
191,01	27			1F	188,21	212	28	80	120,0	92,1	110,0	12,50	PHP 27XH300RSB		
198,09	28			1F	195,29	212	28	80	150,0	92,1	110,0	13,00	PHP 28XH300RSB		
212,23	30			1F	209,43	226	28	80	150,0	92,1	110,0	13,75	PHP 30XH300RSB		
226,38	32			1F	223,58	240	28	80	150,0	92,1	110,0	14,70	PHP 32XH300RSB		
240,53	34			1F	237,73	256	28	80	150,0	92,1	110,0	16,30	PHP 34XH300RSB		
268,83	38			5	266,03	-	32	100	150,0	92,1	120,0	18,30	PHP 38XH300RSB		
282,98	40			5	280,18	-	32	100	150,0	92,1	120,0	19,90	PHP 40XH300RSB		
339,57	48	5	336,77	-	32	100	175,0	92,1	120,0	22,50	PHP 48XH300RSB				
424,47	60	5	421,67	-	32	100	175,0	92,1	120,0	31,50	PHP 60XH300RSB				
XH	101,6	127,34	18	1F	124,54	141	32	67	100,0	119,0	132,0	8,50	PHP 18XH400RSB		
		134,41	19	1F	131,61	146	32	67	100,0	119,0	132,0	9,00	PHP 19XH400RSB		
		141,49	20	1F	138,69	155	32	67	100,0	119,0	132,0	9,40	PHP 20XH400RSB		
		148,56	21	1F	145,76	169	32	73	110,0	119,0	132,0	10,50	PHP 21XH400RSB		
		155,64	22	1F	152,84	169	32	73	110,0	119,0	132,0	11,50	PHP 22XH400RSB		
		169,79	24	1F	166,99	183	32	80	120,0	119,0	132,0	13,40	PHP 24XH400RSB		
		176,86	25	1F	174,06	198	32	80	120,0	119,0	132,0	14,50	PHP 25XH400RSB		
		183,93	26	1F	181,13	198	32	80	120,0	119,0	132,0	15,60	PHP 26XH400RSB		
		191,01	27	1F	188,21	212	32	80	120,0	119,0	132,0	15,10	PHP 27XH400RSB		
		198,09	28	1F	195,29	212	32	100	150,0	119,0	132,0	14,50	PHP 28XH400RSB		
		212,23	30	1F	209,43	227	32	100	150,0	119,0	132,0	16,00	PHP 30XH400RSB		
		226,38	32	1F	223,58	240	32	100	150,0	119,0	132,0	18,00	PHP 32XH400RSB		
		240,53	34	1F	237,73	256	32	100	150,0	119,0	132,0	20,00	PHP 34XH400RSB		
		268,83	38	5	266,03	-	32	100	150,0	119,0	132,0	22,00	PHP 38XH400RSB		
		282,98	40	5	280,18	-	32	100	150,0	119,0	132,0	24,00	PHP 40XH400RSB		
339,57	48	5	336,77	-	32	110	175,0	119,0	132,0	30,80	PHP 48XH400RSB				
424,47	60	5	421,67	-	32	110	175,0	119,0	132,0	36,20	PHP 60XH400RSB				

Classical timing pulleys

L Taper bushed

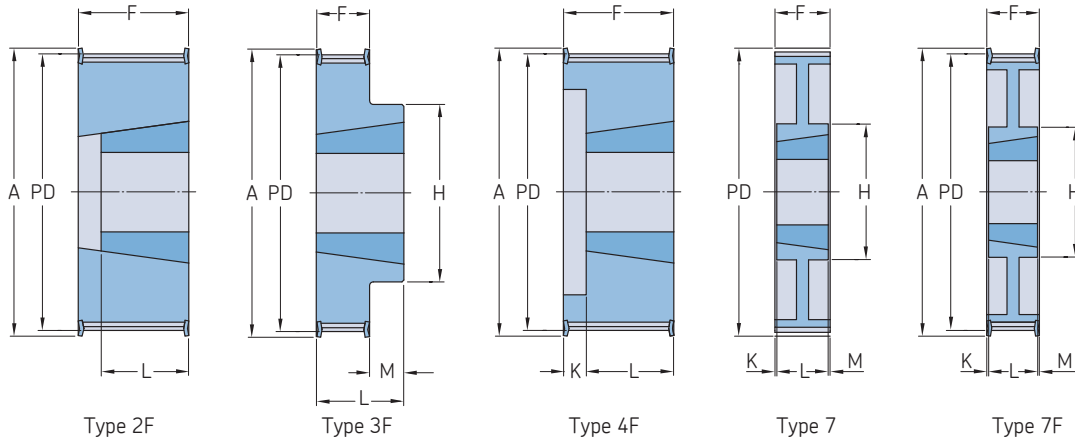

Section	Belt width	Pitch diameter	Number of teeth	Pulley type	Bushing number	Dimensions								Mass*	Designation			
						Outer diameter OD	A	B Min.	Max.	F	K	L	M			H		
		PD	mm													kg		
L	12,7	54,57	18	3F	1108	53,81	60	9	28	19,1	-	22	3,0	45	0,18	PHP 18L050TB		
		57,61	19	3F	1108	56,85	63	9	28	19,1	-	22	3,0	45	0,21	PHP 19L050TB		
		60,64	20	3F	1108	59,88	66	9	28	19,1	-	22	3,0	47	0,24	PHP 20L050TB		
		63,67	21	3F	1108	62,91	69	9	28	19,1	-	22	3,0	49	0,30	PHP 21L050TB		
		66,70	22	3F	1108	65,94	72	9	28	19,1	-	22	3,0	53	0,36	PHP 22L050TB		
		69,73	23	3F	1108	68,97	78	9	28	19,1	-	22	3,0	54	0,39	PHP 23L050TB		
		72,77	24	3F	1108	72,01	78	9	28	19,1	-	22	3,0	54	0,42	PHP 24L050TB		
		75,80	25	3F	1108	75,04	85	9	28	19,1	-	22	3,0	56	0,49	PHP 25L050TB		
		78,83	26	3F	1108	78,07	85	9	28	19,1	-	22	3,0	60	0,54	PHP 26L050TB		
		81,86	27	3F	1108	81,10	91	9	28	19,1	-	22	3,0	62	0,61	PHP 27L050TB		
		84,89	28	3F	1108	84,13	91	9	28	19,1	-	22	3,0	63	0,64	PHP 28L050TB		
		90,06	30	3F	1108	89,30	97	9	28	19,1	-	22	3,0	70	0,77	PHP 30L050TB		
		97,02	32	3F	1108	96,26	103	9	28	19,1	-	22	3,0	74	0,89	PHP 32L050TB		
		109,15	36	3F	1108	108,39	115	9	28	19,1	-	22	3,0	85	1,18	PHP 36L050TB		
		121,28	40	3F	1610	120,52	127	14	42	19,1	-	25	6,0	90	1,35	PHP 40L050TB		
		133,40	44	3F	1610	132,64	139	14	42	19,1	-	25	6,0	90	1,60	PHP 44L050TB		
		145,53	48	9F	1610	144,77	152	14	42	19,1	-	25	6,0	92	1,80	PHP 48L050TB		
		181,91	60	9	1610	181,15	-	14	42	19,1	3,0	25	3,0	92	2,46	PHP 60L050TB		
		218,30	72	9	1610	217,54	-	14	42	19,1	3,0	25	3,0	92	3,29	PHP 72L050TB		
		254,68	84	9	1610	253,92	-	14	42	19,1	3,0	25	3,0	92	4,12	PHP 84L050TB		
		291,06	96	9	2012	290,30	-	14	50	19,1	6,5	32	6,5	111	4,55	PHP 96L050TB		
		363,83	120	9	2012	363,07	-	14	50	19,1	6,5	32	6,5	111	5,71	PHP 120L050TB		
		L	19,1	54,57	18	2F	1108	53,81	60	9	28	25,4	-	25	-	-	0,20	PHP 18L075TB
				57,61	19	2F	1108	56,85	63	9	28	25,4	-	25	-	-	0,30	PHP 19L075TB
				60,64	20	2F	1108	59,88	66	9	28	25,4	-	25	-	-	0,30	PHP 20L075TB
				63,67	21	2F	1108	62,91	69	9	28	25,4	-	25	-	-	0,40	PHP 21L075TB
				66,70	22	2F	1108	65,94	72	9	28	25,4	-	25	-	-	0,40	PHP 22L075TB
				69,73	23	2F	1108	68,97	78	9	28	25,4	-	25	-	-	0,50	PHP 23L075TB
72,77	24			2F	1108	72,01	78	9	28	25,4	-	25	-	-	0,50	PHP 24L075TB		
75,80	25			2F	1108	75,04	85	9	28	25,4	-	25	-	-	0,60	PHP 25L075TB		
78,83	26			2F	1108	78,07	85	9	28	25,4	-	25	-	-	0,70	PHP 26L075TB		
81,86	27			2F	1108	81,10	91	9	28	25,4	-	25	-	-	0,70	PHP 27L075TB		
84,89	28			2F	1108	84,13	91	9	28	25,4	-	25	-	-	0,80	PHP 28L075TB		
90,06	30			2F	1108	90,20	97	9	28	25,4	-	25	-	-	1,00	PHP 30L075TB		
97,02	32			2F	1108	96,26	103	9	28	25,4	-	25	-	-	1,10	PHP 32L075TB		
109,15	36			2F	1610	108,39	115	14	42	25,4	-	25	-	-	1,20	PHP 36L075TB		
121,28	40			2F	1610	120,52	127	14	42	25,4	-	25	-	-	1,60	PHP 40L075TB		
133,40	44			2F	1610	132,64	139	14	42	25,4	-	25	-	-	1,90	PHP 44L075TB		
145,53	48			7F	1610	144,77	152	14	42	25,4	-	25	-	92	2,20	PHP 48L075TB		
181,91	60			7	1610	181,15	-	14	42	25,4	-	25	-	92	3,00	PHP 60L075TB		
218,30	72			8	1610	217,54	-	14	42	25,4	-	25	-	92	4,00	PHP 72L075TB		
254,68	84			9	2012	253,92	-	14	50	25,4	3,5	32	3,5	106	5,20	PHP 84L075TB		
291,06	96			9	2012	290,30	-	14	50	25,4	3,5	32	3,5	106	6,50	PHP 96L075TB		
363,83	120			9	2012	363,07	-	14	50	25,4	3,5	32	3,5	106	7,60	PHP 120L075TB		
L	25,4			54,57	18	4F	1108	53,81	60	9	28	31,8	10,0	22	-	-	0,27	PHP 18L100TB
				57,61	19	4F	1108	56,85	63	9	28	31,8	10,0	22	-	-	0,30	PHP 19L100TB
				60,64	20	4F	1108	59,88	66	9	28	31,8	10,0	22	-	-	0,36	PHP 20L100TB
				63,67	21	4F	1108	62,91	69	9	28	31,8	10,0	22	-	-	0,44	PHP 21L100TB
				66,70	22	4F	1108	65,94	72	9	28	31,8	10,0	22	-	-	0,51	PHP 22L100TB
				69,73	23	4F	1108	68,97	78	9	28	31,8	10,0	22	-	-	0,54	PHP 23L100TB
		72,77	24	4F	1108	72,01	78	9	28	31,8	10,0	22	-	-	0,58	PHP 24L100TB		
		75,80	25	4F	1108	75,04	85	9	28	31,8	10,0	22	-	-	0,67	PHP 25L100TB		
		78,83	26	4F	1108	78,07	85	9	28	31,8	10,0	22	-	-	0,72	PHP 26L100TB		

* Mass does not include bushings.

Classical timing pulleys

L Taper bushed | H Taper bushed

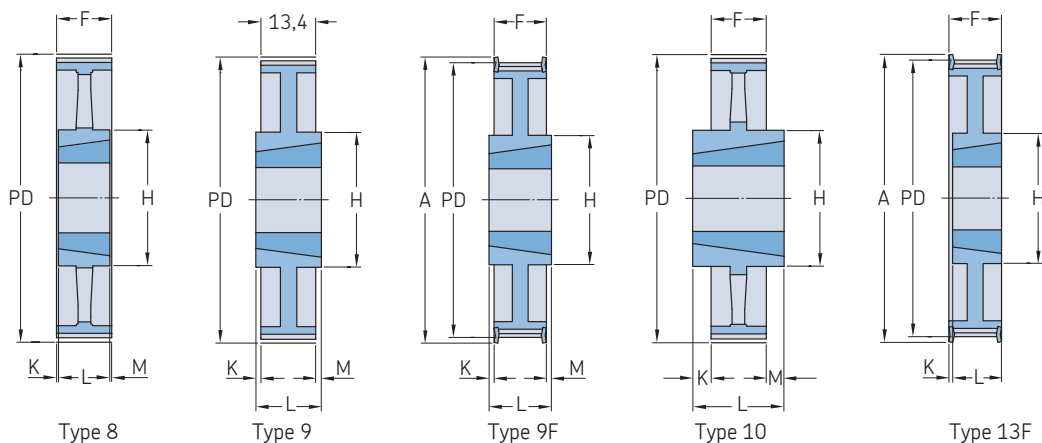

Section	Belt width	Pitch diameter	Number of teeth	Pulley type	Bushing number	Dimensions									Mass*	Designation		
						Outer diameter OD	A	B Min.	Max.	F	K	L	M	H				
-	mm	-	-	-	-	mm	-	-	-	-	-	-	-	-	kg	-		
L	25,4	81,86	27	4F	1108	81,10	91	9	28	31,8	10,0	22	-	-	0,80	PHP 27L100TB		
		84,89	28	4F	1108	84,13	91	9	28	31,8	10,0	22	-	-	0,83	PHP 28L100TB		
		90,96	30	4F	1210	90,20	97	11	32	31,8	7,0	25	-	-	0,94	PHP 30L100TB		
		97,02	32	4F	1210	96,26	103	11	32	31,8	7,0	25	-	-	1,10	PHP 32L100TB		
		109,15	36	4F	1610	108,39	115	14	42	31,8	7,0	25	-	-	1,33	PHP 36L100TB		
		121,28	40	4F	1610	120,52	127	14	42	31,8	7,0	25	-	-	1,70	PHP 40L100TB		
		133,40	44	4F	1610	132,64	139	14	42	31,8	7,0	25	-	-	2,30	PHP 44L100TB		
		145,53	48	13F	1610	144,77	152	14	42	31,8	7,0	25	-	92	2,60	PHP 48L100TB		
		181,91	60	7	1610	181,15	-	14	42	31,8	3,5	25	3,5	92	3,76	PHP 60L100TB		
		218,30	72	10	2012	217,54	-	14	50	31,8	-	32	-	111	4,40	PHP 72L100TB		
		254,68	84	10	2012	253,92	-	14	50	31,8	-	32	-	111	5,87	PHP 84L100TB		
		291,06	96	10	2012	290,30	-	14	50	31,8	-	32	-	111	7,26	PHP 96L100TB		
		363,83	120	10	2012	363,07	-	14	50	31,8	-	32	-	111	8,50	PHP 120L100TB		
		H	19,1	56,60	14	2F	1108	55,23	62	9	28	27,0	-	22	-	-	0,48	PHP 14H075TB
				60,64	15	2F	1108	59,27	67	9	28	27,0	-	22	-	-	0,53	PHP 15H075TB
				64,67	16	2F	1108	63,30	71	9	28	27,0	-	22	-	-	0,57	PHP 16H075TB
				68,72	17	2F	1108	67,35	75	9	28	27,0	-	22	-	-	0,67	PHP 17H075TB
				72,77	18	2F	1210	71,40	79	11	32	27,0	-	25	-	-	0,76	PHP 18H075TB
76,81	19			2F	1210	75,44	83	11	32	27,0	-	25	-	-	0,95	PHP 19H075TB		
80,85	20			2F	1210	79,48	87	11	32	27,0	-	25	-	-	1,05	PHP 20H075TB		
84,89	21			2F	1210	83,52	91	11	32	27,0	-	25	-	-	1,14	PHP 21H075TB		
88,94	22			2F	1210	87,57	95	11	32	27,0	-	25	-	-	1,33	PHP 22H075TB		
92,98	23			2F	1610	91,61	98	14	42	27,0	-	25	-	-	1,43	PHP 23H075TB		
97,02	24			2F	1610	95,65	103	14	42	27,0	-	25	-	-	1,52	PHP 24H075TB		
101,06	25			2F	1610	99,69	107	14	42	27,0	-	25	-	-	1,62	PHP 25H075TB		
105,11	26			2F	1610	103,74	111	14	42	27,0	-	25	-	-	1,71	PHP 26H075TB		
109,15	27			2F	1610	107,78	115	14	42	27,0	-	25	-	-	1,81	PHP 27H075TB		
113,19	28			2F	1610	111,82	119	14	42	27,0	-	25	-	-	1,90	PHP 28H075TB		
117,23	29			2F	1610	115,86	123	14	42	27,0	-	25	-	-	1,95	PHP 29H075TB		
121,28	30			2F	1610	119,91	127	14	42	27,0	-	25	-	-	2,00	PHP 30H075TB		

* Mass does not include bushings.

Classical timing pulleys

H Taper bushed

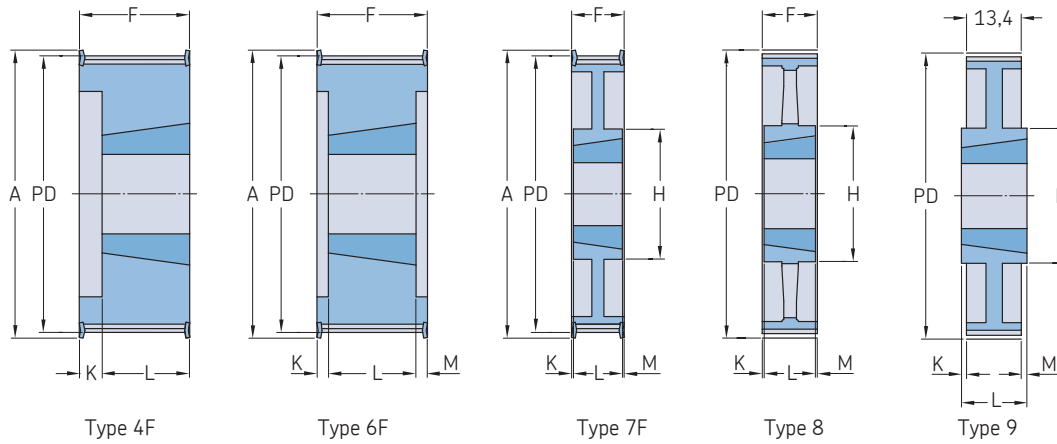

Section	Belt width	Pitch diameter	Number of teeth	Pulley type	Bushing number	Dimensions								Mass*	Designation		
						Outer diameter OD	A	B Min.	Max.	F	K	L	M			H	
		PD	mm													kg	-
H	19,1	129,36	32	14F	1610	127,99	135	14	42	27,0	-	25	-	92	2,09	PHP 32H075TB	
		133,40	33	14F	1610	132,03	142	14	42	27,0	-	25	-	92	2,14	PHP 33H075TB	
		137,45	34	14F	1610	136,08	142	14	42	27,0	-	25	-	92	2,19	PHP 34H075TB	
		141,49	35	14F	1610	140,12	151	14	42	27,0	-	25	-	92	2,24	PHP 35H075TB	
		145,53	36	14F	1610	144,16	151	14	42	27,0	-	25	-	92	2,28	PHP 36H075TB	
		153,62	38	14F	1610	152,25	158	14	42	27,0	-	25	-	92	2,47	PHP 38H075TB	
	161,70	40	14F	1610	160,33	168	14	42	27,0	-	25	-	92	2,66	PHP 40H075TB		
	177,87	44	9F	2012	176,50	184	14	50	27,0	2,5	32	2,5	106	2,57	PHP 44H075TB		
	194,04	48	9F	2012	192,67	200	14	50	27,0	2,5	32	2,5	106	2,85	PHP 48H075TB		
	242,55	60	9	2012	241,18	-	14	50	27,0	2,5	32	2,5	106	2,90	PHP 60H075TB		
	291,06	72	9	2012	289,69	-	14	50	27,0	2,5	32	2,5	112	3,00	PHP 72H075TB		
	339,57	84	9	2012	338,20	-	14	50	27,0	2,5	32	2,5	112	3,15	PHP 84H075TB		
	388,08	96	9	2517	386,71	-	16	60	27,0	9,0	45	9,0	125	3,50	PHP 96H075TB		
	485,10	120	9	2517	483,73	-	16	60	27,0	9,0	45	9,0	125	4,25	PHP 120H075TB		
	H	25,4	56,60	14	4F	1108	55,23	63	9	28	31,0	9,0	22	-	-	0,30	PHP 14H100TB
			60,60	15	4F	1108	59,23	67	9	28	31,0	9,0	22	-	-	0,40	PHP 15H100TB
			64,70	16	4F	1108	63,33	71	9	28	31,0	9,0	22	-	-	0,40	PHP 16H100TB
			68,70	17	4F	1108	67,33	75	9	28	31,0	9,0	22	-	-	0,50	PHP 17H100TB
			72,80	18	4F	1210	71,43	79	11	32	31,0	6,0	25	-	-	0,50	PHP 18H100TB
			76,80	19	4F	1210	75,43	83	11	32	31,0	6,0	25	-	-	0,60	PHP 19H100TB
80,80			20	4F	1210	79,43	87	11	32	31,0	6,0	25	-	-	0,80	PHP 20H100TB	
84,90			21	4F	1210	83,53	91	11	32	32,0	7,0	25	-	-	0,80	PHP 21H100TB	
88,90		22	4F	1210	87,53	95	11	32	32,0	7,0	25	-	-	0,90	PHP 22H100TB		
93,00		23	4F	1610	91,63	98	14	42	32,0	7,0	25	-	-	0,90	PHP 23H100TB		
97,00		24	4F	1610	95,63	103	14	42	32,0	7,0	25	-	-	1,00	PHP 24H100TB		
101,10		25	4F	1610	99,73	107	14	42	32,0	7,0	25	-	-	1,10	PHP 25H100TB		
105,10		26	4F	1610	103,73	111	14	42	32,0	7,0	25	-	-	1,20	PHP 26H100TB		
109,20		27	4F	1610	107,83	115	14	42	32,0	7,0	25	-	-	1,40	PHP 27H100TB		
113,20		28	4F	1610	111,83	119	14	42	32,0	7,0	25	-	-	1,50	PHP 28H100TB		
121,30		30	4F	1610	119,93	127	14	42	32,0	7,0	25	-	-	1,70	PHP 30H100TB		
129,40		32	13F	1610	128,03	135	14	42	32,0	7,0	25	-	92	1,70	PHP 32H100TB		
145,50		36	13F	1610	144,13	151	14	42	32,0	7,0	25	-	92	2,30	PHP 36H100TB		
161,70		40	13F	1610	160,33	168	14	42	32,0	7,0	25	-	92	2,70	PHP 40H100TB		
177,90		44	14F	2012	176,53	184	14	50	32,0	7,0	32	-	106	3,70	PHP 44H100TB		
194,00	48	14F	2012	192,63	200	14	50	32,0	7,0	32	-	106	4,70	PHP 48H100TB			
242,60	60	8	2012	241,23	-	14	50	34,0	1,0	32	1,0	106	7,50	PHP 60H100TB			
291,10	72	8	2012	289,73	-	14	50	34,0	1,0	32	1,0	106	8,40	PHP 72H100TB			
339,60	84	8	2012	338,23	-	14	50	34,0	1,0	32	1,0	106	9,00	PHP 84H100TB			
388,10	96	9	2517	386,73	-	16	60	34,0	5,5	45	5,5	124	11,00	PHP 96H100TB			
485,10	120	9	2517	483,73	-	16	60	34,0	5,5	45	5,5	124	14,00	PHP 120H100TB			
H	38,1	56,60	14	4F	1108	55,23	63	9	28	45,0	23,0	22	-	-	0,50	PHP 14H150TB	
		64,67	16	4F	1108	63,30	71	9	28	45,0	23,0	22	-	-	0,60	PHP 16H150TB	
		72,77	18	4F	1210	71,40	79	11	32	45,0	20,0	25	-	-	0,69	PHP 18H150TB	
		76,81	19	4F	1210	75,44	83	11	32	45,0	20,0	25	-	-	0,86	PHP 19H150TB	
		80,85	20	4F	1210	79,48	87	11	32	45,0	20,0	25	-	-	0,98	PHP 20H150TB	
		84,89	21	4F	1210	83,52	91	11	32	45,0	20,0	25	-	-	0,98	PHP 21H150TB	
	88,94	22	4F	1210	87,57	95	11	32	45,0	20,0	25	-	-	1,10	PHP 22H150TB		
	92,98	23	4F	1610	91,61	98	14	42	45,0	20,0	25	-	-	1,16	PHP 23H150TB		
	97,02	24	4F	1610	95,65	103	14	42	45,0	20,0	25	-	-	1,22	PHP 24H150TB		
	101,06	25	4F	1610	99,69	107	14	42	45,0	20,0	25	-	-	1,37	PHP 25H150TB		
	105,11	26	4F	1610	103,74	111	14	42	45,0	20,0	25	-	-	1,51	PHP 26H150TB		
	109,15	27	4F	1610	107,78	115	14	42	45,0	20,0	25	-	-	1,67	PHP 27H150TB		
113,19	28	4F	1610	111,82	119	14	42	45,0	20,0	25	-	-	1,77	PHP 28H150TB			

* Mass does not include bushings.

Classical timing pulleys

H Taper bushed

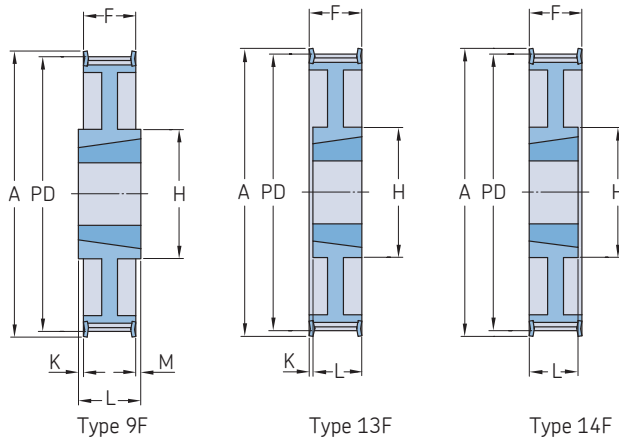

Section	Belt width	Pitch diameter	Number of teeth	Pulley type	Bushing number	Dimensions								Mass*	Designation			
						Outer diameter OD	A	B		F	K	L	M			H		
		PD						Min.	Max.									
		mm	-	-	-	mm								kg	-			
H	38,1	121,28	30	4F	1610	119,91	127	14	42	45,0	20,0	25	-	-	2,05	PHP 30H150TB		
		129,36	32	13F	1610	127,99	135	14	42	45,0	20,0	25	-	92	2,07	PHP 32H150TB		
		145,53	36	13F	1610	144,16	151	14	42	45,0	20,0	25	-	92	2,76	PHP 36H150TB		
		161,70	40	13F	1610	160,33	168	14	42	45,0	20,0	25	-	92	3,34	PHP 40H150TB		
		177,87	44	13F	2012	176,50	184	14	50	45,0	13,0	32	-	106	5,19	PHP 44H150TB		
		194,34	48	13F	2012	192,97	200	14	50	45,0	13,0	32	-	106	5,70	PHP 48H150TB		
		242,55	60	8	2012	241,18	-	14	50	46,0	7,0	32	7,0	106	6,81	PHP 60H150TB		
		291,06	72	8	2012	289,69	-	14	50	46,0	7,0	32	7,0	106	7,79	PHP 72H150TB		
		339,57	84	8	2012	338,20	-	14	50	46,0	7,0	32	7,0	111	9,15	PHP 84H150TB		
		388,08	96	8	2517	386,71	-	16	60	46,0	0,5	45	0,5	124	13,00	PHP 96H150TB		
		485,10	120	8	2517	483,73	-	16	60	46,0	0,5	45	0,5	124	16,80	PHP 120H150TB		
		H	50,8	64,57	16	4F	1108	63,20	71	9	28	58,0	36,0	22	-	-	0,80	PHP 16H200TB
				72,77	18	4F	1210	71,40	79	11	32	58,0	33,0	25	-	-	0,91	PHP 18H200TB
				76,81	19	4F	1210	75,44	83	11	32	58,0	33,0	25	-	-	1,05	PHP 19H200TB
				80,85	20	4F	1610	79,48	87	14	42	58,0	33,0	25	-	-	0,92	PHP 20H200TB
84,89	21			4F	1610	83,52	91	14	42	58,0	33,0	25	-	-	1,04	PHP 21H200TB		
88,94	22			4F	1610	87,57	95	14	42	58,0	33,0	25	-	-	1,18	PHP 22H200TB		
92,98	23			4F	1610	91,61	98	14	42	58,0	33,0	25	-	-	1,28	PHP 23H200TB		
97,02	24			4F	1610	95,65	103	14	42	58,0	33,0	25	-	-	1,37	PHP 24H200TB		
101,06	25			4F	1610	99,69	107	14	42	58,0	33,0	25	-	-	1,59	PHP 25H200TB		
105,11	26			4F	1610	103,74	111	14	42	58,0	33,0	25	-	-	1,63	PHP 26H200TB		
109,15	27			4F	1610	107,78	115	14	42	58,0	33,0	25	-	-	1,98	PHP 27H200TB		
113,19	28			4F	1610	111,82	119	14	42	58,0	33,0	25	-	-	1,92	PHP 28H200TB		
121,28	30			4F	1610	119,91	127	14	42	58,0	33,0	25	-	-	2,24	PHP 30H200TB		
129,36	32			4F	2012	127,99	135	14	50	58,0	26,0	32	-	-	2,87	PHP 32H200TB		
145,53	36			13F	2012	144,16	151	14	50	58,0	26,0	32	-	-	3,42	PHP 36H200TB		
161,70	40			13F	2012	160,33	168	14	50	58,0	26,0	32	-	-	4,39	PHP 40H200TB		
177,87	44			13F	2012	176,50	184	14	50	58,0	26,0	32	-	-	5,89	PHP 44H200TB		
194,04	48			13F	2517	192,67	200	16	60	58,0	13,0	45	-	-	7,00	PHP 48H200TB		
242,55	60			8	2517	241,18	-	16	60	60,0	7,5	45	7,5	-	8,88	PHP 60H200TB		
291,06	72			8	2517	289,69	-	16	60	60,0	7,5	45	7,5	-	9,05	PHP 72H200TB		
339,57	84			8	2517	338,20	-	16	60	60,0	7,5	45	7,5	-	10,66	PHP 84H200TB		
388,08	96			8	2517	386,71	-	16	60	60,0	7,5	45	7,5	-	15,28	PHP 96H200TB		
485,10	120			8	2517	483,73	-	16	60	60,0	7,5	45	7,5	-	20,16	PHP 120H200TB		
H	76,2			72,77	18	6F	1215	71,40	83	11	32	84,0	23,0	38	23,0	-	1,10	PHP 18H300TB
				80,85	20	6F	1615	79,48	87	14	42	84,0	23,0	38	23,0	-	1,25	PHP 20H300TB
				84,89	21	6F	1615	83,52	91	14	42	84,0	23,0	38	23,0	-	1,56	PHP 21H300TB
				88,94	22	6F	1615	87,57	94	14	42	84,0	23,0	38	23,0	-	1,75	PHP 22H300TB
		92,98	23	6F	1615	91,61	98	14	42	84,0	23,0	38	23,0	-	1,93	PHP 23H300TB		
		97,02	24	6F	1615	95,65	103	14	42	84,0	23,0	38	23,0	-	2,14	PHP 24H300TB		
		101,06	25	6F	1615	99,69	107	14	42	84,0	23,0	38	23,0	-	2,21	PHP 25H300TB		
		105,11	26	6F	1615	103,74	111	14	42	84,0	23,0	38	23,0	-	2,65	PHP 26H300TB		
		109,15	27	6F	2012	107,78	115	14	50	84,0	26,0	32	26,0	-	2,49	PHP 27H300TB		
		113,19	28	6F	2012	111,82	119	14	50	84,0	26,0	32	26,0	-	2,88	PHP 28H300TB		
		121,28	30	6F	2012	119,91	127	14	50	84,0	26,0	32	26,0	-	3,44	PHP 30H300TB		
		129,36	32	6F	2517	127,99	135	16	60	84,0	19,5	45	19,5	-	3,51	PHP 32H300TB		
		145,53	36	6F	2517	144,16	151	16	60	84,0	19,5	45	19,5	-	4,43	PHP 36H300TB		
		161,70	40	6F	2517	160,33	168	16	60	84,0	19,5	45	19,5	-	6,10	PHP 40H300TB		
		177,87	44	7F	2517	176,50	184	16	60	86,0	20,5	45	20,5	124	7,55	PHP 44H300TB		
		194,04	48	7F	2517	192,67	200	16	60	86,0	20,5	45	20,5	124	8,99	PHP 48H300TB		
		242,55	60	8	2517	241,18	-	16	60	86,0	20,5	45	20,5	124	11,06	PHP 60H300TB		
		291,06	72	8	2517	289,69	-	16	60	86,0	20,5	45	20,5	124	12,66	PHP 72H300TB		
		339,57	84	8	2517	338,20	-	16	60	86,0	20,5	45	20,5	124	14,50	PHP 84H300TB		

* Mass does not include bushings.

Classical timing pulleys

H Taper bushed | XH Taper bushed

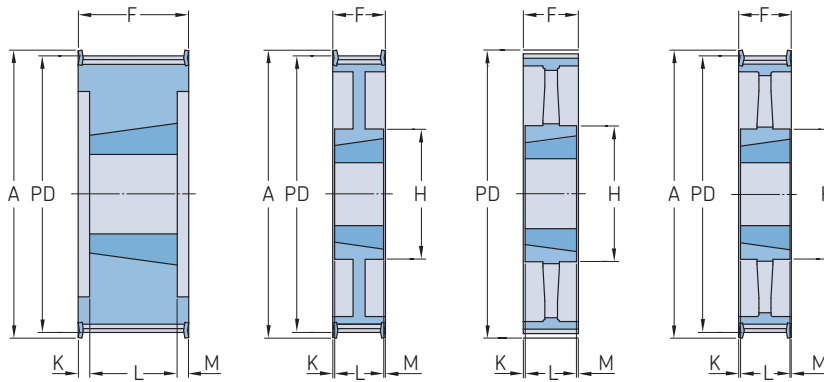

Type 6F

Type 7F

Type 8

Type 8F

Section	Belt width	Pitch diameter	Number of teeth	Pulley type	Bushing number	Dimensions		Bushing		F	K	L	M	H	Mass*	Designation	
						Outer diameter OD	A	B Min.	Max.								
		PD														kg	
		mm															
H	76,2	388,08	96	8	3030	386,71	–	35	75	86,0	5,0	76	5,0	155	16,20	PHP 96H300TB	
		485,10	120	8	3030	483,73	–	35	75	86,0	5,0	76	5,0	155	20,80	PHP 120H300TB	
XH	50,8	127,34	18	6F	2012	124,54	141	14	50	65,1	–	32	–	–	2,60	PHP 18XH200TB	
		134,41	19	6F	2012	131,61	146	14	50	65,1	–	32	–	–	3,10	PHP 19XH200TB	
		141,49	20	6F	2012	138,69	155	14	50	65,1	–	32	–	–	3,60	PHP 20XH200TB	
		148,56	21	6F	2517	145,76	169	16	60	65,1	–	45	–	–	4,20	PHP 21XH200TB	
		155,64	22	6F	2517	152,84	169	16	60	65,1	–	45	–	–	4,80	PHP 22XH200TB	
		169,79	24	6F	2517	166,99	183	16	60	65,1	–	45	–	–	6,10	PHP 24XH200TB	
		176,86	25	6F	2517	174,06	198	16	60	65,1	–	45	–	–	6,80	PHP 25XH200TB	
		183,93	26	6F	2517	181,13	198	16	60	65,1	–	45	–	–	7,40	PHP 26XH200TB	
		191,01	27	7F	2517	188,21	212	16	60	65,1	–	45	–	134	8,20	PHP 27XH200TB	
		198,09	28	7F	2517	195,29	212	16	60	65,1	–	45	–	134	9,00	PHP 28XH200TB	
		212,23	30	7F	2517	209,43	226	16	60	65,1	–	45	–	134	9,60	PHP 30XH200TB	
		226,38	32	7F	2517	223,58	240	16	60	65,1	–	45	–	134	9,80	PHP 32XH200TB	
		254,64	36	8F	2517	251,84	267	16	60	65,1	–	45	–	134	11,60	PHP 36XH200TB	
		282,98	40	8	2517	280,18	–	16	60	65,1	–	45	–	134	13,30	PHP 40XH200TB	
		339,57	48	8	3020	336,77	–	25	75	65,1	–	51	–	165	19,00	PHP 48XH200TB	
		424,47	60	8	3020	421,67	–	25	75	65,1	–	51	–	165	22,00	PHP 60XH200TB	
XH	76,2	127,34	18	6F	2012	124,54	141	14	50	92,1	–	45	–	–	3,70	PHP 18XH300TB	
		134,41	19	6F	2517	131,61	146	16	60	92,1	–	45	–	–	4,20	PHP 19XH300TB	
		141,49	20	6F	2517	138,69	155	16	60	92,1	–	45	–	–	4,70	PHP 20XH300TB	
		148,56	21	6F	2517	145,76	169	16	60	92,1	–	45	–	–	5,40	PHP 21XH300TB	
		155,64	22	6F	2517	152,84	169	16	60	92,1	–	45	–	–	6,00	PHP 22XH300TB	
		169,79	24	6F	2517	166,99	183	16	60	92,1	–	45	–	–	7,60	PHP 24XH300TB	
		176,86	25	6F	2517	174,06	198	16	60	92,1	–	45	–	–	8,70	PHP 25XH300TB	
		183,93	26	6F	2517	181,13	198	16	60	92,1	–	45	–	–	9,80	PHP 26XH300TB	
		191,01	27	6F	2517	188,21	212	16	60	92,1	–	45	–	–	10,70	PHP 27XH300TB	
		198,09	28	7F	2517	195,29	212	16	60	92,1	–	45	–	134	11,60	PHP 28XH300TB	
		212,23	30	7F	2517	209,43	226	16	60	92,1	–	45	–	134	11,90	PHP 30XH300TB	
		226,38	32	7F	3020	223,58	240	25	75	92,1	–	51	–	165	13,80	PHP 32XH300TB	
		254,64	36	7F	3020	251,84	267	25	75	92,1	–	51	–	165	16,70	PHP 36XH300TB	
		282,98	40	8	3020	280,18	–	25	75	92,1	–	51	–	165	19,50	PHP 40XH300TB	
		339,57	48	8	3020	336,77	–	25	75	92,1	–	51	–	165	27,00	PHP 48XH300TB	
		424,47	60	8	3535	421,67	–	35	90	92,1	–	89	–	184	28,00	PHP 60XH300TB	
XH	101,6	127,34	18	6F	2012	124,54	141	16	60	92,1	–	45	–	–	5,00	PHP 18XH400TB	
		134,41	19	6F	2517	131,61	146	16	60	92,1	–	45	–	–	5,50	PHP 19XH400TB	
		141,49	20	6F	2517	138,69	155	16	60	92,1	–	45	–	–	6,00	PHP 20XH400TB	
		148,56	21	6F	2517	145,76	169	16	60	92,1	–	45	–	–	6,60	PHP 21XH400TB	
		155,64	22	6F	2517	152,84	169	16	60	92,1	–	45	–	–	7,20	PHP 22XH400TB	
		169,79	24	6F	3020	166,99	183	25	75	92,1	–	51	–	–	8,40	PHP 24XH400TB	
		176,86	25	6F	3020	174,06	198	25	75	92,1	–	51	–	–	9,40	PHP 25XH400TB	
		183,93	26	6F	3020	181,13	198	25	75	92,1	–	51	–	–	10,30	PHP 26XH400TB	
		191,01	27	6F	3020	188,21	212	25	75	92,1	–	51	–	–	11,30	PHP 27XH400TB	
		198,09	28	6F	3020	195,29	212	25	75	92,1	–	51	–	–	12,30	PHP 28XH400TB	
		212,23	30	6F	3020	209,43	226	25	75	92,1	–	51	–	–	14,30	PHP 30XH400TB	
		226,38	32	7F	3020	223,58	240	25	75	92,1	–	51	–	165	19,90	PHP 32XH400TB	
		254,64	36	7F	3020	251,84	267	25	75	92,1	–	51	–	165	22,30	PHP 36XH400TB	
		282,98	40	8	3020	280,18	–	25	75	92,1	–	51	–	165	24,60	PHP 40XH400TB	
		339,57	48	8	3535	336,77	–	35	90	92,1	–	89	–	184	30,00	PHP 48XH400TB	
		424,47	60	8	3535	421,67	–	35	90	92,1	–	89	–	184	40,00	PHP 60XH400TB	

* Mass does not include bushings.

Metric timing pulleys

2,5 mm pitch type T pilot bore (RSB)

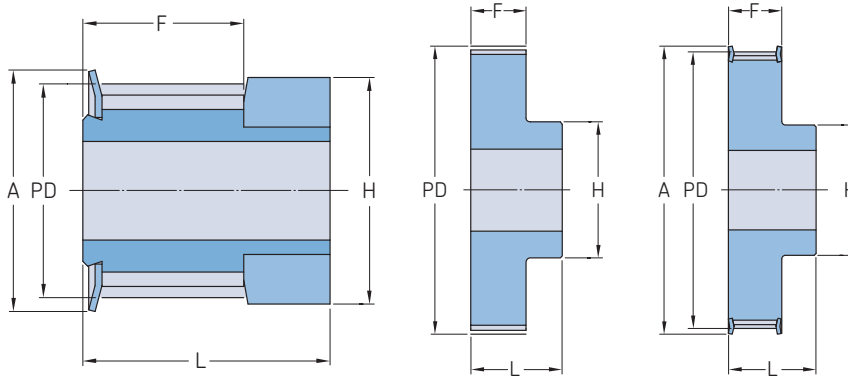

Type OF

Type 1

Type 1F

Pitch	Belt width	Pitch diameter PD	Number of teeth	Pulley type	Dimensions Outer diameter OD	Dimensions					Mass	Designation	
						A	B Min.	Max.	H	F			L
-	mm	-	-	-	mm	-	-	-	-	-	kg	-	
2,5	4 and 6	7,96	10	OF	7,45	10	-	3	10	10	16	0,001	PHP 16-T2.5-10RSB
		8,75	11	OF	8,25	12	-	3	11	10	16	0,002	PHP 16-T2.5-11RSB
		9,54	12	OF	9,00	13	-	4	13	10	16	0,003	PHP 16-T2.5-12RSB
		10,35	13	OF	9,95	14	-	4	14	10	16	0,004	PHP 16-T2.5-13RSB
		11,14	14	OF	10,60	15	-	5	15	10	16	0,004	PHP 16-T2.5-14RSB
		11,94	15	OF	11,40	15	-	6	15	10	16	0,010	PHP 16-T2.5-15RSB
		12,73	16	OF	12,20	16	-	7	16	10	16	0,005	PHP 16-T2.5-16RSB
		13,53	17	OF	13,00	17	4	7	16	10	16	0,006	PHP 16-T2.5-17RSB
		14,32	18	1F	13,80	18	4	7	10	10	16	0,006	PHP 16-T2.5-18RSB
		15,12	19	1F	14,60	18	4	7	10	10	16	0,007	PHP 16-T2.5-19RSB
		15,92	20	1F	15,40	20	4	7	11	10	16	0,008	PHP 16-T2.5-20RSB
		16,71	21	1F	16,20	20	4	7	11	10	16	0,009	PHP 16-T2.5-21RSB
		17,51	22	1F	17,00	23	4	7	10	10	16	0,009	PHP 16-T2.5-22RSB
		18,30	23	1F	17,80	23	4	8	12	10	16	0,010	PHP 16-T2.5-23RSB
		19,10	24	1F	18,55	23	4	8	12	10	16	0,012	PHP 16-T2.5-24RSB
		19,89	25	1F	19,35	23	4	9	13	10	16	0,013	PHP 16-T2.5-25RSB
	20,69	26	1F	20,15	25	4	9	14	10	16	0,014	PHP 16-T2.5-26RSB	
	21,49	27	1F	20,90	25	4	9	14	10	16	0,015	PHP 16-T2.5-27RSB	
	22,28	28	1F	21,75	25	4	9	14	10	16	0,016	PHP 16-T2.5-28RSB	
	23,87	30	1F	23,35	28	6	10	16	10	16	0,018	PHP 16-T2.5-30RSB	
	25,46	32	1F	24,95	32	6	10	16	10	16	0,020	PHP 16-T2.5-32RSB	
	27,85	35	1F	27,35	36	6	10	18	10	16	0,024	PHP 16-T2.5-35RSB	
	28,65	36	1F	28,10	36	6	13	20	10	16	0,026	PHP 16-T2.5-36RSB	
	30,24	38	1F	31,70	38	6	13	22	10	16	0,029	PHP 16-T2.5-38RSB	
	31,83	40	1F	31,30	38	6	13	22	10	16	0,032	PHP 16-T2.5-40RSB	
	33,42	42	1F	32,90	42	6	15	24	10	16	0,036	PHP 16-T2.5-42RSB	
	35,01	44	1	34,50	-	6	15	24	10	16	0,040	PHP 16-T2.5-44RSB	
	35,81	45	1	35,30	-	6	17	26	10	16	0,044	PHP 16-T2.5-45RSB	
	38,20	48	1	37,70	-	6	17	26	10	16	0,048	PHP 16-T2.5-48RSB	
	42,97	54	1	42,45	-	8	19	30	10	16	0,056	PHP 16-T2.5-54RSB	
	45,36	57	1	44,85	-	8	19	32	10	16	0,064	PHP 16-T2.5-57RSB	
	47,75	60	1	47,25	-	8	22	34	10	16	0,073	PHP 16-T2.5-60RSB	
2,5	10	7,96	10	OF	7,45	10	3	3	10	14	20	0,010	PHP 20-T2.5-10RSB
		8,75	11	OF	8,25	12	3	3	11	14	20	0,010	PHP 20-T2.5-11RSB
		9,55	12	OF	9,00	13	3	4	13	14	20	0,020	PHP 20-T2.5-12RSB
		10,35	13	OF	9,95	14	3	4	14	14	20	0,020	PHP 20-T2.5-13RSB
		11,14	14	OF	10,60	14	3	5	15	14	20	0,020	PHP 20-T2.5-14RSB
		11,94	15	OF	11,40	15	3	6	15	14	20	0,020	PHP 20-T2.5-15RSB
		12,73	16	OF	12,20	16	4	7	16	14	20	0,030	PHP 20-T2.5-16RSB
		13,53	17	1F	13,00	17	4	7	16	14	20	0,020	PHP 20-T2.5-17RSB
		14,32	18	1F	□3,80	17	4	7	10	14	20	0,030	PHP 20-T2.5-18RSB
		15,12	19	1F	14,60	18	4	7	10	14	20	0,040	PHP 20-T2.5-19RSB
		15,92	20	1F	15,40	19	4	7	11	14	20	0,040	PHP 20-T2.5-20RSB
		16,71	21	1F	16,20	20	4	7	11	14	20	0,040	PHP 20-T2.5-21RSB
		17,60	22	1F	17,00	22	4	7	11	14	20	0,050	PHP 20-T2.5-22RSB
		18,30	23	1F	17,80	22	4	8	12	14	20	0,050	PHP 20-T2.5-23RSB
	19,10	24	1F	18,55	22	4	8	12	14	20	0,050	PHP 20-T2.5-24RSB	
	19,89	25	1F	19,35	24	4	9	13	14	20	0,060	PHP 20-T2.5-25RSB	
	20,75	26	1F	20,15	26	4	9	14	14	20	0,060	PHP 20-T2.5-26RSB	
	21,49	27	1F	20,90	26	4	9	14	14	20	0,060	PHP 20-T2.5-27RSB	
	22,35	28	1F	21,75	26	4	9	14	14	20	0,070	PHP 20-T2.5-28RSB	
	23,87	30	1F	23,35	28	6	10	16	14	20	0,080	PHP 20-T2.5-30RSB	
	25,47	32	1F	24,95	28	6	10	16	14	20	0,090	PHP 20-T2.5-32RSB	

Metric timing pulleys

2,5 mm pitch type T pilot bore (RSB) | 5 mm pitch type T pilot bore (RSB)

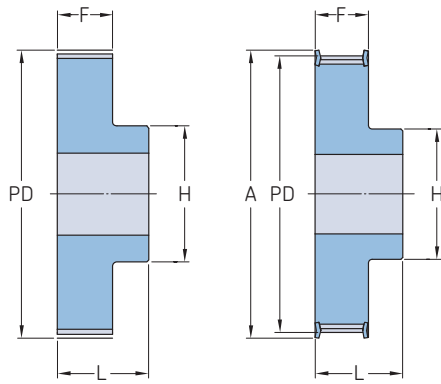

Type 1

Type 1F

Pitch	Belt width	Pitch diameter PD	Number of teeth	Pulley type	Dimensions							Mass	Designation		
					Outer diameter OD	A	B Min.	Max.	H	F	L				
-	mm	-	-	-	mm	-	-	-	-	-	-	kg	-		
2,5	10	27,85	35	1F	27,35	32	6	10	18	14	20	0,110	PHP 20-T2.5-35RSB		
		28,65	36	1F	28,10	32	6	13	20	14	20	0,110	PHP 20-T2.5-36RSB		
		30,24	38	1F	39,70	34	6	13	22	14	20	0,130	PHP 20-T2.5-38RSB		
		31,83	40	1F	31,30	35	6	13	22	14	20	0,140	PHP 20-T2.5-40RSB		
		33,42	42	1	32,90	-	6	15	24	14	20	0,180	PHP 20-T2.5-42RSB		
		35,01	44	1	34,50	-	6	15	24	14	20	0,190	PHP 20-T2.5-44RSB		
		35,81	45	1	35,30	-	6	17	26	14	20	0,190	PHP 20-T2.5-45RSB		
		38,20	48	1	37,70	-	6	17	26	14	20	0,200	PHP 20-T2.5-48RSB		
		42,97	54	1	42,45	-	8	19	30	14	20	0,250	PHP 20-T2.5-54RSB		
		45,36	57	1	44,85	-	8	19	32	14	20	0,280	PHP 20-T2.5-57RSB		
		47,75	60	1	47,25	-	8	22	34	14	20	0,310	PHP 20-T2.5-60RSB		
		5	10	15,92	10	1F	15,05	20	4	5	8	15	21	0,010	PHP 21-T5-10RSB
				17,51	11	1F	16,65	22	4	6	10	15	21	0,010	PHP 21-T5-11RSB
				19,10	12	1F	18,25	23	4	7	12	15	21	0,020	PHP 21-T5-12RSB
				20,69	13	1F	19,85	25	6	8	13	15	21	0,020	PHP 21-T5-13RSB
				22,29	14	1F	21,45	26	6	9	14	15	21	0,020	PHP 21-T5-14RSB
23,88	15			1F	23,05	28	6	10	16	15	21	0,020	PHP 21-T5-15RSB		
25,47	16			1F	24,60	30	6	11	18	15	21	0,030	PHP 21-T5-16RSB		
27,06	17			1F	26,20	32	6	12	19	15	21	0,030	PHP 21-T5-17RSB		
28,65	18			1F	27,80	32	6	13	20	15	21	0,030	PHP 21-T5-18RSB		
30,25	19			1F	29,40	36	6	14	22	15	21	0,040	PHP 21-T5-19RSB		
31,83	20			1F	31,00	36	6	15	24	15	21	0,040	PHP 21-T5-20RSB		
33,42	21			1F	32,55	38	6	15	24	15	21	0,040	PHP 21-T5-21RSB		
35,01	22			1F	34,15	38	6	15	24	15	21	0,050	PHP 21-T5-22RSB		
36,61	23			1F	35,75	42	6	16	25	15	21	0,050	PHP 21-T5-23RSB		
38,21	24			1F	37,40	44	6	17	26	15	21	0,050	PHP 21-T5-24RSB		
39,80	25			1F	38,95	44	6	17	26	15	21	0,060	PHP 21-T5-25RSB		
41,45	26			1F	40,60	44	6	17	26	15	21	0,060	PHP 21-T5-26RSB		
42,98	27			1F	42,20	48	8	19	30	15	21	0,060	PHP 21-T5-27RSB		
44,56	28			1F	43,75	48	8	20	32	15	21	0,060	PHP 21-T5-28RSB		
47,76	30			1F	46,95	51	8	22	34	15	21	0,080	PHP 21-T5-30RSB		
50,94	32			1F	50,10	54	8	24	38	15	21	0,090	PHP 21-T5-32RSB		
55,70	35			1F	54,85	59	8	24	38	15	21	0,100	PHP 21-T5-35RSB		
57,31	36			1F	56,45	63	8	24	38	15	21	0,110	PHP 21-T5-36RSB		
60,48	38			1F	59,65	66	8	26	40	15	21	0,130	PHP 21-T5-38RSB		
63,66	40			1F	62,85	66	8	26	40	15	21	0,140	PHP 21-T5-40RSB		
66,84	42			1F	66,00	71	8	26	40	15	21	0,180	PHP 21-T5-42RSB		
70,20	44			1	69,35	-	8	29	45	15	21	0,190	PHP 21-T5-44RSB		
71,62	45			1	70,80	-	8	31	45	15	21	0,190	PHP 21-T5-45RSB		
76,39	48			1	75,55	-	8	32	50	15	21	0,200	PHP 21-T5-48RSB		
85,94	54			1	85,10	-	8	35	55	15	21	0,240	PHP 21-T5-54RSB		
90,72	57			1	89,90	-	8	38	60	15	21	0,270	PHP 21-T5-57RSB		
95,49	60			1	94,65	-	8	42	65	15	21	0,310	PHP 21-T5-60RSB		
5	16	15,92	10	1F	15,05	20	4	5	8	21	27	0,020	PHP 27-T5-10RSB		
		17,51	11	1F	16,65	22	4	6	10	21	27	0,020	PHP 27-T5-11RSB		
		19,10	12	1F	18,25	23	4	7	12	21	27	0,020	PHP 27-T5-12RSB		
		20,69	13	1F	19,85	25	6	8	13	21	27	0,020	PHP 27-T5-13RSB		
		22,29	14	1F	21,45	26	6	9	14	21	27	0,030	PHP 27-T5-14RSB		
		23,88	15	1F	23,05	28	6	10	16	21	27	0,030	PHP 27-T5-15RSB		
		25,47	16	1F	24,60	30	6	11	18	21	27	0,040	PHP 27-T5-16RSB		
		27,06	17	1F	26,20	32	6	12	19	21	27	0,040	PHP 27-T5-17RSB		
		28,65	18	1F	27,80	33	6	13	20	21	27	0,050	PHP 27-T5-18RSB		
		30,25	19	1F	29,40	36	6	14	22	21	27	0,050	PHP 27-T5-19RSB		

Metric timing pulleys

5 mm pitch type T pilot bore (RSB) | 10 mm pitch type T pilot bore (RSB)

Pitch	Belt width	Pitch diameter	Number of teeth	Pulley type	Dimensions							Mass	Designation		
					Outer diameter OD	A	B Min.	Max.	H	F	L				
-	mm	PD	-	-	mm	-	-	-	-	-	-	kg	-		
5	16	31,83	20	1F	31,00	36	6	15	24	21	27	0,050	PHP 27-T5-20RSB		
		33,42	21	1F	32,55	38	6	15	24	21	27	0,050	PHP 27-T5-21RSB		
		35,01	22	1F	34,15	38	6	15	24	21	27	0,050	PHP 27-T5-22RSB		
		36,61	23	1F	35,75	42	6	16	25	21	27	0,060	PHP 27-T5-23RSB		
		38,21	24	1F	37,40	42	6	17	26	21	27	0,080	PHP 27-T5-24RSB		
		39,80	25	1F	38,95	44	6	17	26	21	27	0,080	PHP 27-T5-25RSB		
		41,45	26	1F	40,60	44	6	17	26	21	27	0,090	PHP 27-T5-26RSB		
		42,98	27	1F	42,20	48	8	19	30	21	27	0,090	PHP 27-T5-27RSB		
		44,56	28	1F	43,75	48	8	20	32	21	27	0,090	PHP 27-T5-28RSB		
		47,76	30	1F	46,95	51	8	22	34	21	27	0,110	PHP 27-T5-30RSB		
		50,94	32	1F	50,10	54	8	24	38	21	27	0,120	PHP 27-T5-32RSB		
		55,70	35	1F	54,85	59	8	24	38	21	27	0,140	PHP 27-T5-35RSB		
		57,31	36	1F	56,45	63	8	24	38	21	27	0,160	PHP 27-T5-36RSB		
		60,48	38	1F	59,65	66	8	26	40	21	27	0,180	PHP 27-T5-38RSB		
		63,66	40	1F	62,85	66	8	26	40	21	27	0,190	PHP 27-T5-40RSB		
		66,84	42	1F	66,00	71	8	26	40	21	27	0,210	PHP 27-T5-42RSB		
		70,20	44	1	69,35	-	8	29	45	21	27	0,230	PHP 27-T5-44RSB		
		71,62	45	1	70,80	-	8	29	45	21	27	0,260	PHP 27-T5-45RSB		
		76,39	48	1	75,55	-	8	32	50	21	27	0,280	PHP 27-T5-48RSB		
		85,94	54	1	85,10	-	8	35	55	21	27	0,330	PHP 27-T5-54RSB		
		90,72	57	1	89,90	-	8	38	60	21	27	0,380	PHP 27-T5-57RSB		
		95,49	60	1	94,65	-	8	42	65	21	27	0,430	PHP 27-T5-60RSB		
		5	25	15,92	10	1F	15,05	20	4	5	8	30	36	0,020	PHP 36-T5-10RSB
				17,51	11	1F	16,65	22	4	6	10	30	36	0,030	PHP 36-T5-11RSB
19,10	12			1F	18,25	23	4	7	12	30	36	0,030	PHP 36-T5-12RSB		
20,69	13			1F	19,85	25	6	8	13	30	36	0,030	PHP 36-T5-13RSB		
22,29	14			1F	21,45	26	6	9	14	30	36	0,040	PHP 36-T5-14RSB		
23,88	15			1F	23,05	28	6	10	16	30	36	0,040	PHP 36-T5-15RSB		
25,47	16			1F	24,60	32	6	11	18	30	36	0,050	PHP 36-T5-16RSB		
27,06	17			1F	26,20	32	6	12	19	30	36	0,060	PHP 36-T5-17RSB		
28,65	18			1F	27,80	32	6	13	20	30	36	0,060	PHP 36-T5-18RSB		
30,25	19			1F	29,40	36	6	14	22	30	36	0,070	PHP 36-T5-19RSB		
31,83	20			1F	31,00	36	6	15	24	30	36	0,080	PHP 36-T5-20RSB		
33,42	21			1F	32,55	38	6	15	24	30	36	0,080	PHP 36-T5-21RSB		
35,01	22			1F	34,15	38	6	15	24	30	36	0,080	PHP 36-T5-22RSB		
36,61	23			1F	35,75	42	6	15	25	30	36	0,090	PHP 36-T5-23RSB		
38,21	24			1F	37,40	42	6	17	26	30	36	0,110	PHP 36-T5-24RSB		
39,80	25			1F	38,95	44	6	17	26	30	36	0,120	PHP 36-T5-25RSB		
41,45	26			1F	40,60	44	6	17	26	30	36	0,120	PHP 36-T5-26RSB		
42,98	27			1F	42,20	48	8	19	30	30	36	0,130	PHP 36-T5-27RSB		
44,56	28			1F	43,75	48	8	20	32	30	36	0,130	PHP 36-T5-28RSB		
47,76	30			1F	46,95	51	8	22	34	30	36	0,150	PHP 36-T5-30RSB		
50,94	32			1F	50,10	54	8	24	38	30	36	0,180	PHP 36-T5-32RSB		
55,70	35			1F	54,85	59	8	24	38	30	36	0,210	PHP 36-T5-35RSB		
57,31	36			1F	56,45	63	8	24	38	30	36	0,230	PHP 36-T5-36RSB		
60,48	38			1F	59,65	66	8	26	40	30	36	0,250	PHP 36-T5-38RSB		
63,66	40			1F	62,85	66	8	26	40	30	36	0,280	PHP 36-T5-40RSB		
66,84	42			1F	66,00	71	8	26	40	30	36	0,280	PHP 36-T5-42RSB		
70,20	44			1	69,35	-	8	29	45	30	36	0,320	PHP 36-T5-44RSB		
71,62	45			1	70,80	-	8	29	45	30	36	0,360	PHP 36-T5-45RSB		
76,39	48			1	75,55	-	8	32	50	30	36	0,400	PHP 36-T5-48RSB		
85,94	54			1	85,10	-	8	35	55	30	36	0,470	PHP 36-T5-54RSB		
90,72	57			1	89,90	-	8	38	60	30	36	0,540	PHP 36-T5-57RSB		
95,49	60			1	94,65	-	8	42	65	30	36	0,610	PHP 36-T5-60RSB		
10	16			38,20	12	1F	36,35	42	6	18	28	21	31	0,080	PHP 31-T10-12RSB
				41,38	13	1F	39,55	44	6	19	32	21	31	0,090	PHP 31-T10-13RSB
				44,56	14	1F	42,70	48	8	21	32	21	31	0,100	PHP 31-T10-14RSB
				47,75	15	1F	45,90	51	8	21	32	21	31	0,120	PHP 31-T10-15RSB
		50,93	16	1F	49,10	54	8	23	35	21	31	0,130	PHP 31-T10-16RSB		
		54,11	17	1F	52,25	58	8	24	38	21	31	0,150	PHP 31-T10-17RSB		
		57,29	18	1F	55,45	60	8	26	40	21	31	0,170	PHP 31-T10-18RSB		
		60,48	19	1F	58,65	66	8	28	44	21	31	0,180	PHP 31-T10-19RSB		
		63,66	20	1F	61,80	66	8	30	46	21	31	0,210	PHP 31-T10-20RSB		
		66,85	21	1F	65,00	71	8	36	48	21	31	0,230	PHP 31-T10-21RSB		
		70,03	22	1F	68,20	75	8	34	52	21	31	0,250	PHP 31-T10-22RSB		
		73,21	23	1F	71,35	77	8	36	55	21	31	0,270	PHP 31-T10-23RSB		
		76,39	24	1F	74,55	83	8	38	58	21	31	0,290	PHP 31-T10-24RSB		
		79,58	25	1F	77,75	83	8	39	60	21	31	0,310	PHP 31-T10-25RSB		
		82,76	26	1F	80,90	87	8	39	60	21	31	0,360	PHP 31-T10-26RSB		
		85,95	27	1F	84,10	91	8	39	60	21	31	0,360	PHP 31-T10-27RSB		
		89,25	28	1F	87,25	93	8	39	60	21	31	0,400	PHP 31-T10-28RSB		
		95,49	30	1F	93,65	99	8	39	60	21	31	0,440	PHP 31-T10-30RSB		
		101,86	32	1F	100,00	106	10	42	65	21	31	0,490	PHP 31-T10-32RSB		

Metric timing pulleys
10 mm pitch type T pilot bore (RSB)

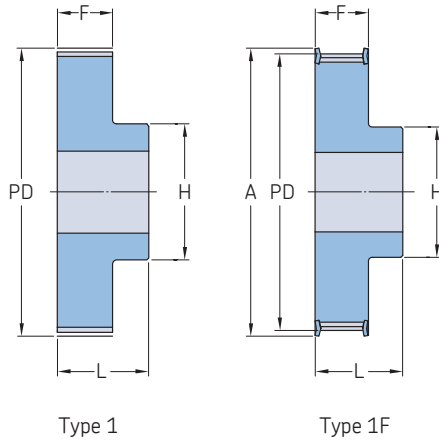

Pitch	Belt width	Pitch diameter PD	Number of teeth	Pulley type	Dimensions							Mass	Designation		
					Outer diameter OD	A	B Min.	Max.	H	F	L				
-	mm	-	-	-	mm	-	-	-	-	-	-	kg	-		
10	16	111,41	35	1F	109,55	115	10	45	70	21	31	0,560	PHP 31-T10-35RSB		
		114,59	36	1F	112,75	119	10	45	70	21	31	0,620	PHP 31-T10-36RSB		
		120,96	38	1F	119,10	125	10	48	75	21	31	0,690	PHP 31-T10-38RSB		
		127,32	40	1F	125,45	131	10	52	80	21	31	0,770	PHP 31-T10-40RSB		
		133,69	42	1	131,85	-	10	52	80	21	31	0,880	PHP 31-T10-42RSB		
		140,06	44	1	138,20	-	10	57	88	21	31	0,990	PHP 31-T10-44RSB		
		143,24	45	1	141,40	-	16	57	90	21	31	1,040	PHP 31-T10-45RSB		
		152,78	48	1	150,95	-	16	62	95	21	31	1,090	PHP 31-T10-48RSB		
		171,89	54	1	170,05	-	16	66	100	21	31	1,300	PHP 31-T10-54RSB		
		181,44	57	1	179,60	-	16	66	110	21	31	1,500	PHP 31-T10-57RSB		
		190,98	60	1	189,15	-	16	72	110	21	31	1,710	PHP 31-T10-60RSB		
		10	25	38,20	12	1F	36,35	42	6	18	28	30	40	0,100	PHP 40-T10-12RSB
				41,38	13	1F	39,55	44	6	19	30	30	40	0,120	PHP 40-T10-13RSB
				44,56	14	1F	42,70	48	8	21	32	30	40	0,130	PHP 40-T10-14RSB
				47,75	15	1F	45,90	51	8	21	32	30	40	0,150	PHP 40-T10-15RSB
				50,93	16	1F	49,10	54	8	23	35	30	40	0,180	PHP 40-T10-16RSB
54,11	17			1F	52,25	58	8	24	37	30	40	0,200	PHP 40-T10-17RSB		
57,29	18			1F	55,45	60	8	26	40	30	40	0,220	PHP 40-T10-18RSB		
60,48	19			1F	58,65	66	8	28	44	30	40	0,250	PHP 40-T10-19RSB		
63,66	20			1F	61,80	66	8	30	46	30	40	0,280	PHP 40-T10-20RSB		
66,85	21			1F	65,00	71	8	32	49	30	40	0,300	PHP 40-T10-21RSB		
70,03	22			1F	68,20	75	8	34	52	30	40	0,340	PHP 40-T10-22RSB		
73,21	23			1F	71,35	77	8	36	55	30	40	0,360	PHP 40-T10-23RSB		
76,39	24			1F	74,55	83	8	38	58	30	40	0,390	PHP 40-T10-24RSB		
79,58	25			1F	77,75	83	8	39	60	30	40	0,420	PHP 40-T10-25RSB		
82,76	26			1F	80,90	87	8	39	60	30	40	0,480	PHP 40-T10-26RSB		
85,95	27			1F	84,10	91	8	39	60	30	40	0,540	PHP 40-T10-27RSB		
89,25	28			1F	87,25	93	8	39	60	30	40	0,540	PHP 40-T10-28RSB		
95,49	30			1F	93,65	99	8	39	60	30	40	0,640	PHP 40-T10-30RSB		
101,86	32			1F	100,00	106	10	42	65	30	40	0,690	PHP 40-T10-32RSB		
111,41	35			1F	109,55	115	10	45	70	30	40	0,780	PHP 40-T10-35RSB		
114,59	36			1F	112,75	119	10	45	70	30	40	0,870	PHP 40-T10-36RSB		
120,96	38			1F	119,10	125	10	48	75	30	40	0,970	PHP 40-T10-38RSB		
127,32	40			1F	125,45	131	10	52	80	30	40	1,070	PHP 40-T10-40RSB		
133,69	42			1	131,85	-	10	52	80	30	40	1,210	PHP 40-T10-42RSB		
140,06	44			1	138,20	-	10	57	88	30	40	1,350	PHP 40-T10-44RSB		
143,24	45			1	141,40	-	16	59	90	30	40	1,430	PHP 40-T10-45RSB		
152,78	48			1	150,95	-	16	62	95	30	40	1,520	PHP 40-T10-48RSB		
171,89	54			1	170,05	-	16	65	100	30	40	1,790	PHP 40-T10-54RSB		
181,44	57			1	179,60	-	16	72	110	30	40	2,060	PHP 40-T10-57RSB		
190,98	60			1	189,15	-	16	72	110	30	40	2,340	PHP 40-T10-60RSB		
10	32			57,30	18	1F	55,45	60	10	26	40	37	47	0,250	PHP 47-T10-18RSB
				60,48	19	1F	58,65	66	10	28	44	37	47	0,290	PHP 47-T10-19RSB
		63,66	20	1F	61,80	66	12	30	46	37	47	0,320	PHP 47-T10-20RSB		
		66,85	21	1F	65,00	71	12	32	49	37	47	0,360	PHP 47-T10-21RSB		
		70,03	22	1F	68,20	75	12	34	52	37	47	0,390	PHP 47-T10-22RSB		
		73,21	23	1F	71,35	77	12	36	55	37	47	0,430	PHP 47-T10-23RSB		
		76,39	24	1F	74,55	83	12	38	58	37	47	0,480	PHP 47-T10-24RSB		
		79,58	25	1F	77,75	83	12	39	60	37	47	0,530	PHP 47-T10-25RSB		
		82,76	26	1F	80,90	87	12	39	60	37	47	0,560	PHP 47-T10-26RSB		
		85,94	27	1F	84,10	91	12	39	60	37	47	0,600	PHP 47-T10-27RSB		
		89,13	28	1F	87,25	93	12	39	60	37	47	0,640	PHP 47-T10-28RSB		
		95,49	30	1F	93,65	99	12	39	60	37	47	0,740	PHP 47-T10-30RSB		

Metric timing pulleys

10 mm pitch type T pilot bore (RSB)

Pitch	Belt width	Pitch diameter PD	Number of teeth	Pulley type	Dimensions							Mass	Designation		
					Outer diameter OD	A	B Min.	Max.	H	F	L				
–	mm	–	–	–	mm	–	–	–	–	–	–	kg	–		
10	32	101,86	32	1F	100,00	106	12	42	65	37	47	0,840	PHP 47-T10-32RSB		
		111,41	35	1F	109,55	115	16	45	70	37	47	0,960	PHP 47-T10-35RSB		
		114,59	36	1F	112,75	119	16	45	70	37	47	1,080	PHP 47-T10-36RSB		
		120,96	38	1F	119,10	125	16	48	75	37	47	1,200	PHP 47-T10-38RSB		
		127,32	40	1F	125,45	131	16	52	80	37	47	1,320	PHP 47-T10-40RSB		
		133,69	42	1	131,85	–	16	52	80	37	47	1,460	PHP 47-T10-42RSB		
		140,06	44	1	138,20	–	16	57	88	37	47	1,610	PHP 47-T10-44RSB		
		143,24	45	1	141,40	–	16	58	90	37	47	1,770	PHP 47-T10-45RSB		
		152,79	48	1	150,95	–	16	62	95	37	47	1,930	PHP 47-T10-48RSB		
		171,89	54	1	170,05	–	16	65	100	37	47	2,290	PHP 47-T10-54RSB		
		181,44	57	1	179,60	–	16	72	110	37	47	2,650	PHP 47-T10-57RSB		
		190,99	60	1	189,15	–	16	72	110	37	47	3,000	PHP 47-T10-60RSB		
		10	50	57,30	18	1F	55,45	60	10	26	40	56	66	0,420	PHP 66-T10-18RSB
				60,48	19	1F	58,65	66	10	28	44	56	66	0,470	PHP 66-T10-19RSB
				63,66	20	1F	61,80	66	12	30	46	56	66	0,520	PHP 66-T10-20RSB
				66,85	21	1F	65,00	71	12	32	49	56	66	0,550	PHP 66-T10-21RSB
				70,03	22	1F	68,20	75	12	34	52	56	66	0,570	PHP 66-T10-22RSB
				73,21	23	1F	71,35	77	12	36	55	56	66	0,650	PHP 66-T10-23RSB
76,39	24			1F	74,55	83	12	38	58	56	66	0,740	PHP 66-T10-24RSB		
79,58	25			1F	77,75	83	12	39	60	56	66	0,770	PHP 66-T10-25RSB		
82,76	26			1F	80,90	87	12	39	60	56	66	0,820	PHP 66-T10-26RSB		
85,94	27			1F	84,10	91	12	39	60	56	66	0,950	PHP 66-T10-27RSB		
89,13	28			1F	87,25	93	12	39	60	56	66	0,960	PHP 66-T10-28RSB		
95,49	30			1F	93,65	99	12	39	60	56	66	1,170	PHP 66-T10-30RSB		
101,86	32			1F	100,00	106	12	42	65	56	66	1,300	PHP 66-T10-32RSB		
111,41	35			1F	109,55	115	16	45	70	56	66	1,470	PHP 66-T10-35RSB		
114,59	36			1F	112,75	119	16	45	70	56	66	1,640	PHP 66-T10-36RSB		
120,96	38			1F	119,10	125	16	48	75	56	66	1,820	PHP 66-T10-38RSB		
127,32	40			1F	125,45	131	16	52	80	56	66	2,000	PHP 66-T10-40RSB		
133,69	42			1	131,85	–	16	57	80	56	66	2,180	PHP 66-T10-42RSB		
140,06	44			1	138,20	–	16	52	88	56	66	2,360	PHP 66-T10-44RSB		
143,24	45			1	141,40	–	16	58	90	56	66	2,590	PHP 66-T10-45RSB		
152,79	48			1	150,95	–	16	62	95	56	66	2,830	PHP 66-T10-48RSB		
171,89	54			1	170,05	–	16	65	100	56	66	3,340	PHP 66-T10-54RSB		
181,44	57			1	179,60	–	16	72	110	56	66	3,850	PHP 66-T10-57RSB		
190,99	60			1	189,15	–	16	72	110	56	66	4,370	PHP 66-T10-60RSB		

Metric timing pulleys
5 mm pitch type AT pilot bore (RSB)

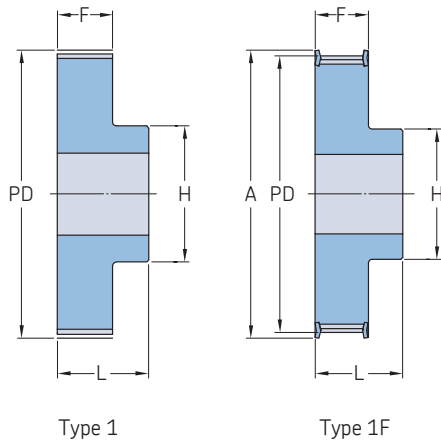

Pitch	Belt width	Pitch diameter PD	Number of teeth	Pulley type	Dimensions							Mass	Designation	
					Outer diameter OD	A	B Min.	Max.	H	F	L			
mm			-	-	mm							kg	-	
5	10	15,92	10	1F	14,65	20	4	5	8	15	21	0,01	PHP 21-AT5-10RSB	
		19,10	12	1F	17,85	23	4	7	12	15	21	0,02	PHP 21-AT5-12RSB	
		20,69	13	1F	19,45	25	6	8	13	15	21	0,02	PHP 21-AT5-13RSB	
		22,29	14	1F	21,05	26	6	9	14	15	21	0,02	PHP 21-AT5-14RSB	
		23,88	15	1F	22,65	28	6	10	16	15	21	0,02	PHP 21-AT5-15RSB	
		25,47	16	1F	24,20	32	6	11	18	15	21	0,03	PHP 21-AT5-16RSB	
		27,06	17	1F	25,80	32	6	12	19	15	21	0,03	PHP 21-AT5-17RSB	
		28,65	18	1F	27,40	32	6	13	20	15	21	0,03	PHP 21-AT5-18RSB	
		30,25	19	1F	29,00	36	6	14	22	15	21	0,04	PHP 21-AT5-19RSB	
		31,83	20	1F	30,60	36	6	15	23	15	21	0,04	PHP 21-AT5-20RSB	
		33,42	21	1F	32,20	38	6	15	24	15	21	0,04	PHP 21-AT5-21RSB	
		35,02	22	1F	33,85	38	6	15	24	15	21	0,05	PHP 21-AT5-22RSB	
		36,61	23	1F	35,40	42	6	17	25	15	21	0,05	PHP 21-AT5-23RSB	
		38,21	24	1F	37,00	44	6	17	26	15	21	0,05	PHP 21-AT5-24RSB	
		39,80	25	1F	38,60	44	6	17	26	15	21	0,06	PHP 21-AT5-25RSB	
		41,38	26	1F	40,20	44	6	17	26	15	21	0,06	PHP 21-AT5-26RSB	
	42,98	27	1F	41,80	48	8	19	30	15	21	0,06	PHP 21-AT5-27RSB		
	44,56	28	1F	43,35	48	8	20	32	15	21	0,07	PHP 21-AT5-28RSB		
	47,76	30	1F	46,55	51	8	22	34	15	21	0,08	PHP 21-AT5-30RSB		
	50,94	32	1F	49,70	54	8	24	38	15	21	0,09	PHP 21-AT5-32RSB		
	57,31	36	1F	56,05	63	8	24	38	15	21	0,11	PHP 21-AT5-36RSB		
	60,48	38	1F	59,25	66	8	26	40	15	21	0,13	PHP 21-AT5-38RSB		
	63,66	40	1F	62,45	66	8	26	40	15	21	0,14	PHP 21-AT5-40RSB		
	66,74	42	1F	65,60	71	8	26	40	15	21	0,18	PHP 21-AT5-42RSB		
	70,05	44	1	68,80	-	8	29	45	15	21	0,19	PHP 21-AT5-44RSB		
	71,62	45	1	70,35	-	8	29	45	15	21	0,19	PHP 21-AT5-45RSB		
	76,42	48	1	75,15	-	8	32	50	15	21	0,20	PHP 21-AT5-48RSB		
	95,52	60	1	94,25	-	8	37	65	15	21	0,31	PHP 21-AT5-60RSB		
	114,62	72	1	113,15	-	10	42	80	15	21	0,41	PHP 21-AT5-72RSB		
	5	16	15,92	10	1F	14,65	20	4	5	8	21	27	0,02	PHP 27-AT5-10RSB
			19,10	12	1F	17,85	23	4	7	12	21	27	0,02	PHP 27-AT5-12RSB
			20,69	13	1F	19,45	25	6	8	13	21	27	0,02	PHP 27-AT5-13RSB
22,29			14	1F	21,05	26	6	9	14	21	27	0,03	PHP 27-AT5-14RSB	
23,88			15	1F	22,65	28	6	10	16	21	27	0,03	PHP 27-AT5-15RSB	
25,47			16	1F	24,20	32	6	11	18	21	27	0,04	PHP 27-AT5-16RSB	
27,06			17	1F	25,80	32	6	12	19	21	27	0,04	PHP 27-AT5-17RSB	
28,65			18	1F	27,40	32	6	13	20	21	27	0,04	PHP 27-AT5-18RSB	
30,25			19	1F	29,00	36	6	14	22	21	27	0,05	PHP 27-AT5-19RSB	
31,83			20	1F	30,60	36	6	15	23	21	27	0,05	PHP 27-AT5-20RSB	
33,42			21	1F	32,20	38	6	15	24	21	27	0,05	PHP 27-AT5-21RSB	
35,02			22	1F	33,85	38	6	15	24	21	27	0,05	PHP 27-AT5-22RSB	
36,61			23	1F	35,40	42	6	17	25	21	27	0,07	PHP 27-AT5-23RSB	
38,21			24	1F	37,00	44	6	17	26	21	27	0,08	PHP 27-AT5-24RSB	
39,80			25	1F	38,60	44	6	17	26	21	27	0,08	PHP 27-AT5-25RSB	
41,38			26	1F	40,20	44	6	17	26	21	27	0,09	PHP 27-AT5-26RSB	
42,98		27	1F	41,80	48	8	19	30	21	27	0,09	PHP 27-AT5-27RSB		
44,56		28	1F	43,35	48	8	20	32	21	27	0,09	PHP 27-AT5-28RSB		
47,76		30	1F	46,55	51	8	22	34	21	27	0,11	PHP 27-AT5-30RSB		
50,94		32	1F	49,70	54	8	24	38	21	27	0,12	PHP 27-AT5-32RSB		
57,31		36	1F	56,05	63	8	24	38	21	27	0,16	PHP 27-AT5-36RSB		
60,48		38	1F	59,25	66	8	26	40	21	27	0,18	PHP 27-AT5-38RSB		
63,66		40	1F	62,45	66	8	26	40	21	27	0,19	PHP 27-AT5-40RSB		
66,74		42	1F	65,60	71	8	26	40	21	27	0,21	PHP 27-AT5-42RSB		
70,05		44	1	68,80	-	8	29	45	21	27	0,23	PHP 27-AT5-44RSB		

Metric timing pulleys

5 mm pitch type AT pilot bore (RSB) | 10 mm pitch type AT pilot bore (RSB)

Pitch	Belt width	Pitch diameter	Number of teeth	Pulley type	Dimensions							Mass	Designation		
					Outer diameter OD	A	B Min.	Max.	H	F	L				
mm		PD	-	-	mm						kg	-			
5	16	71,62	45	1	70,35	-	8	29	45	21	27	0,26	PHP 27-AT5-45RSB		
		76,42	48	1	75,15	-	8	32	50	21	27	0,28	PHP 27-AT5-48RSB		
		95,52	60	1	94,25	-	8	37	65	21	27	0,43	PHP 27-AT5-60RSB		
		114,62	72	1	113,15	-	10	42	80	21	27	0,41	PHP 27-AT5-72RSB		
5	25	15,92	10	1F	14,65	20	4	5	8	30	36	0,02	PHP 36-AT5-10RSB		
		19,10	12	1F	17,85	23	6	7	12	30	36	0,03	PHP 36-AT5-12RSB		
		20,69	13	1F	19,45	25	6	8	13	30	36	0,03	PHP 36-AT5-13RSB		
		22,29	14	1F	21,05	26	6	9	14	30	36	0,04	PHP 36-AT5-14RSB		
		23,88	15	1F	22,65	28	6	10	16	30	36	0,04	PHP 36-AT5-15RSB		
		25,47	16	1F	24,20	32	6	11	18	30	36	0,05	PHP 36-AT5-16RSB		
		27,06	17	1F	25,80	32	6	12	19	30	36	0,06	PHP 36-AT5-17RSB		
		28,65	18	1F	27,40	32	6	13	20	30	36	0,06	PHP 36-AT5-18RSB		
		30,25	19	1F	29,00	36	6	14	22	30	36	0,07	PHP 36-AT5-19RSB		
		31,83	20	1F	30,60	36	6	15	23	30	36	0,08	PHP 36-AT5-20RSB		
		33,42	21	1F	32,20	38	6	15	24	30	36	0,08	PHP 36-AT5-21RSB		
		35,02	22	1F	33,85	38	6	15	24	30	36	0,08	PHP 36-AT5-22RSB		
		36,61	23	1F	35,40	42	6	16	25	30	36	0,09	PHP 36-AT5-23RSB		
		38,21	24	1F	37,00	44	8	17	26	30	36	0,11	PHP 36-AT5-24RSB		
		39,80	25	1F	38,60	44	8	17	26	30	36	0,12	PHP 36-AT5-25RSB		
		41,38	26	1F	40,20	44	8	17	26	30	36	0,12	PHP 36-AT5-26RSB		
		42,98	27	1F	41,80	48	8	19	30	30	36	0,13	PHP 36-AT5-27RSB		
		44,56	28	1F	43,35	48	8	20	32	30	36	0,13	PHP 36-AT5-28RSB		
		47,76	30	1F	46,55	51	8	22	34	30	36	0,15	PHP 36-AT5-30RSB		
		50,94	32	1F	49,70	54	8	24	38	30	36	0,18	PHP 36-AT5-32RSB		
		57,31	36	1F	56,05	63	8	24	38	30	36	0,23	PHP 36-AT5-36RSB		
		60,48	38	1F	59,25	66	8	26	40	30	36	0,25	PHP 36-AT5-38RSB		
		63,66	40	1F	62,45	66	8	26	40	30	36	0,28	PHP 36-AT5-40RSB		
		66,74	42	1F	65,60	71	8	26	40	30	36	0,28	PHP 36-AT5-42RSB		
		70,05	44	1	68,80	-	8	29	45	30	36	0,32	PHP 36-AT5-44RSB		
		71,62	45	1	70,35	-	8	30	45	30	36	0,36	PHP 36-AT5-45RSB		
		76,42	48	1	75,15	-	8	32	50	30	36	0,40	PHP 36-AT5-48RSB		
		95,52	60	1	94,25	-	8	37	65	30	36	0,61	PHP 36-AT5-60RSB		
		114,62	72	1	113,15	-	10	42	80	30	36	0,83	PHP 36-AT5-72RSB		
		10	16	38,20	12	1F	36,35	42	6	18	28	21	31	0,08	PHP 31-AT10-12RSB
				44,60	14	1F	42,70	48	8	21	32	21	31	0,10	PHP 31-AT10-14RSB
				47,75	15	1F	45,90	51	8	21	32	21	31	0,12	PHP 31-AT10-15RSB
50,93	16			1F	49,05	54	8	23	35	21	31	0,13	PHP 31-AT10-16RSB		
54,11	17			1F	52,25	58	8	24	38	21	31	0,15	PHP 31-AT10-17RSB		
57,29	18			1F	55,45	60	8	26	40	21	31	0,17	PHP 31-AT10-18RSB		
60,48	19			1F	58,65	66	8	28	44	21	31	0,19	PHP 31-AT10-19RSB		
63,66	20			1F	61,80	66	8	30	46	21	31	0,21	PHP 31-AT10-20RSB		
66,85	21			1F	65,00	71	8	32	48	21	31	0,23	PHP 31-AT10-21RSB		
70,03	22			1F	68,15	75	8	34	52	21	31	0,25	PHP 31-AT10-22RSB		
73,21	23			1F	71,35	77	8	36	55	21	31	0,27	PHP 31-AT10-23RSB		
76,39	24			1F	74,55	83	8	38	58	21	31	0,29	PHP 31-AT10-24RSB		
79,58	25			1F	77,75	83	8	39	60	21	31	0,31	PHP 31-AT10-25RSB		
82,76	26			1F	80,90	87	8	39	60	21	31	0,36	PHP 31-AT10-26RSB		
85,95	27			1F	84,10	91	8	39	60	21	31	0,36	PHP 31-AT10-27RSB		
89,25	28			1F	87,25	93	8	39	60	21	31	0,40	PHP 31-AT10-28RSB		
95,49	30			1F	93,65	99	8	39	60	21	31	0,44	PHP 31-AT10-30RSB		
101,86	32			1F	100,00	106	10	42	65	21	31	0,49	PHP 31-AT10-32RSB		
114,59	36			1F	112,75	119	10	45	70	21	31	0,63	PHP 31-AT10-36RSB		
120,96	38			1F	119,10	125	10	48	75	21	31	0,70	PHP 31-AT10-38RSB		
127,32	40	1F	125,45	131	10	52	80	21	31	0,77	PHP 31-AT10-40RSB				
133,69	42	1	131,85	-	10	57	80	21	31	0,88	PHP 31-AT10-42RSB				
140,05	44	1	138,20	-	10	57	88	21	31	0,99	PHP 31-AT10-44RSB				
143,24	45	1	141,40	-	16	59	90	21	31	1,01	PHP 31-AT10-45RSB				
152,78	48	1	150,95	-	16	62	95	21	31	1,09	PHP 31-AT10-48RSB				
190,98	60	1	189,15	-	16	72	110	21	31	1,71	PHP 31-AT10-60RSB				
10	25	38,20	12	1F	36,40	42	6	18	28	30	40	0,10	PHP 40-AT10-12RSB		
		44,60	14	1F	42,70	48	8	21	32	30	40	0,13	PHP 40-AT10-14RSB		
		47,80	15	1F	45,90	51	8	21	32	30	40	0,15	PHP 40-AT10-15RSB		
		50,90	16	1F	49,10	54	8	23	35	30	40	0,18	PHP 40-AT10-16RSB		
		54,10	17	1F	52,20	58	8	24	37	30	40	0,20	PHP 40-AT10-17RSB		
		57,30	18	1F	55,50	60	8	26	40	30	40	0,22	PHP 40-AT10-18RSB		
		60,50	19	1F	58,60	66	8	28	44	30	40	0,25	PHP 40-AT10-19RSB		
		63,70	20	1F	61,80	66	8	30	46	30	40	0,28	PHP 40-AT10-20RSB		
		66,80	21	1F	65,00	71	8	32	49	30	40	0,31	PHP 40-AT10-21RSB		
		70,00	22	1F	68,20	75	8	34	52	30	40	0,34	PHP 40-AT10-22RSB		
		73,20	23	1F	71,30	77	8	36	55	30	40	0,36	PHP 40-AT10-23RSB		
		76,40	24	1F	74,50	83	8	38	58	30	40	0,39	PHP 40-AT10-24RSB		
		79,60	25	1F	77,80	83	8	39	60	30	40	0,42	PHP 40-AT10-25RSB		
		82,80	26	1F	80,90	87	8	39	60	30	40	0,48	PHP 40-AT10-26RSB		

Metric timing pulleys
10 mm pitch type AT pilot bore (RSB)

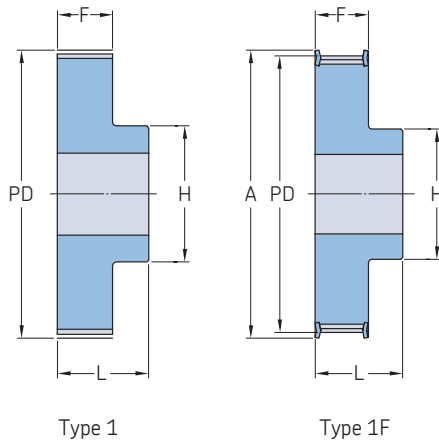

Pitch	Belt width	Pitch diameter PD	Number of teeth	Pulley type	Dimensions							Mass	Designation		
					Outer diameter OD	A	B Min.	Max.	H	F	L				
mm			-	-	mm							kg	-		
10	25	86,00	27	1F	84,10	91	8	39	60	30	40	0,54	PHP 40-AT10-27RSB		
		89,20	28	1F	87,20	93	8	39	60	30	40	0,54	PHP 40-AT10-28RSB		
		95,50	30	1F	93,70	99	8	39	60	30	40	0,64	PHP 40-AT10-30RSB		
		101,90	32	1F	100,00	106	10	42	65	30	40	0,69	PHP 40-AT10-32RSB		
		114,60	36	1F	112,80	119	10	45	70	30	40	0,87	PHP 40-AT10-36RSB		
		121,00	38	1F	119,10	125	10	48	75	30	40	0,97	PHP 40-AT10-38RSB		
		127,30	40	1F	125,50	131	10	52	80	30	40	1,07	PHP 40-AT10-40RSB		
		133,70	42	1	131,80	-	10	57	80	30	40	1,21	PHP 40-AT10-42RSB		
		140,10	44	1	138,20	-	10	57	88	30	40	1,35	PHP 40-AT10-44RSB		
		143,20	45	1	141,40	-	16	59	90	30	40	1,43	PHP 40-AT10-45RSB		
		152,80	48	1	150,90	-	16	62	95	30	40	1,52	PHP 40-AT10-48RSB		
		191,00	60	1	189,20	-	16	72	110	30	40	2,34	PHP 40-AT10-60RSB		
		10	32	57,29	18	1F	55,45	60	8	26	40	37	47	0,25	PHP 47-AT10-18RSB
				60,48	19	1F	58,65	66	8	28	44	37	47	0,29	PHP 47-AT10-19RSB
				63,66	20	1F	61,80	66	8	30	46	37	47	0,32	PHP 47-AT10-20RSB
				66,85	21	1F	65,00	71	8	32	49	37	47	0,36	PHP 47-AT10-21RSB
				70,03	22	1F	68,15	75	8	34	52	37	47	0,39	PHP 47-AT10-22RSB
				73,21	23	1F	71,35	77	8	36	55	37	47	0,43	PHP 47-AT10-23RSB
76,39	24			1F	74,55	83	8	38	58	37	47	0,48	PHP 47-AT10-24RSB		
79,58	25			1F	77,75	83	8	39	60	37	47	0,53	PHP 47-AT10-25RSB		
82,76	26			1F	80,90	87	8	39	60	37	47	0,56	PHP 47-AT10-26RSB		
85,95	27			1F	84,10	91	8	39	60	37	47	0,60	PHP 47-AT10-27RSB		
89,25	28			1F	87,25	93	8	39	60	37	47	0,64	PHP 47-AT10-28RSB		
95,49	30			1F	93,65	99	8	39	60	37	47	0,74	PHP 47-AT10-30RSB		
101,86	32			1F	100,00	106	10	42	65	37	47	0,84	PHP 47-AT10-32RSB		
111,41	35			1F	109,55	115	10	45	70	37	47	0,96	PHP 47-AT10-35RSB		
114,59	36			1F	112,75	119	10	45	70	37	47	1,08	PHP 47-AT10-36RSB		
120,96	38			1F	119,10	125	10	48	75	37	47	1,20	PHP 47-AT10-38RSB		
127,32	40			1F	125,45	131	10	52	80	37	47	1,32	PHP 47-AT10-40RSB		
133,69	42			1	131,85	-	10	57	80	37	47	1,46	PHP 47-AT10-42RSB		
140,20	44			1	138,20	-	10	57	88	37	47	1,61	PHP 47-AT10-44RSB		
143,24	45			1	141,40	-	10	59	90	37	47	1,77	PHP 47-AT10-45RSB		
152,78	48			1	150,95	-	16	62	95	37	47	1,93	PHP 47-AT10-48RSB		
171,89	54			1	170,05	-	16	66	100	37	47	2,29	PHP 47-AT10-54RSB		
181,44	57			1	179,60	-	16	72	110	37	47	2,64	PHP 47-AT10-57RSB		
190,98	60			1	189,15	-	16	72	110	37	47	3,00	PHP 47-AT10-60RSB		
10	50			57,29	18	1F	55,45	60	10	26	40	56	66	0,42	PHP 66-AT10-18RSB
				60,48	19	1F	58,65	66	10	28	44	56	66	0,47	PHP 66-AT10-19RSB
				63,66	20	1F	61,80	66	12	30	46	56	66	0,52	PHP 66-AT10-20RSB
				66,85	21	1F	65,00	71	12	32	49	56	66	0,55	PHP 66-AT10-21RSB
				70,20	22	1F	68,15	75	12	34	52	56	66	0,57	PHP 66-AT10-22RSB
				73,21	23	1F	71,35	77	12	36	55	56	66	0,65	PHP 66-AT10-23RSB
		76,39	24	1F	74,55	83	12	38	58	56	66	0,74	PHP 66-AT10-24RSB		
		79,58	25	1F	77,75	83	12	39	60	56	66	0,77	PHP 66-AT10-25RSB		
		82,76	26	1F	80,90	87	12	39	60	56	66	0,82	PHP 66-AT10-26RSB		
		85,95	27	1F	84,10	90	12	39	60	56	66	0,95	PHP 66-AT10-27RSB		
		89,25	28	1F	87,25	93	12	39	60	56	66	0,96	PHP 66-AT10-28RSB		
		95,49	30	1F	93,65	99	12	39	60	56	66	1,17	PHP 66-AT10-30RSB		
		101,86	32	1F	100,00	106	12	42	65	56	66	1,30	PHP 66-AT10-32RSB		
		111,41	35	1F	109,55	115	16	45	70	56	66	1,47	PHP 66-AT10-35RSB		
		114,59	36	1F	112,75	119	16	45	70	56	66	1,64	PHP 66-AT10-36RSB		
		120,96	38	1F	119,10	125	16	48	75	56	66	1,82	PHP 66-AT10-38RSB		
		127,32	40	1F	125,45	131	16	52	80	56	66	2,00	PHP 66-AT10-40RSB		

Metric timing pulleys

10 mm pitch type AT pilot bore (RSB)

Pitch	Belt width	Pitch diameter PD	Number of teeth	Pulley type	Dimensions						Mass	Designation			
					Outer diameter OD	A	B Min.	Max.	H	F			L		
mm			–	–	mm							kg	–		
10	50	133,69	42	1	131,85	–	16	57	80	56	66	2,18	PHP 66-AT10-42RSB		
		140,20	44	1	138,20	–	16	57	88	56	66	2,36	PHP 66-AT10-44RSB		
		143,24	45	1	141,40	–	16	59	90	56	66	2,59	PHP 66-AT10-45RSB		
		152,78	48	1	150,95	–	16	62	95	56	66	2,83	PHP 66-AT10-48RSB		
		171,89	54	1	170,05	–	16	66	100	56	66	3,34	PHP 66-AT10-54RSB		
		181,44	57	1	179,60	–	16	72	110	56	66	3,85	PHP 66-AT10-57RSB		
		190,98	60	1	189,15	–	16	72	110	56	66	4,37	PHP 66-AT10-60RSB		